



## Datenblatt

2026-05-26

# Kos V

Vertikaler Designheizkörper mit klarer Linienführung



- ✓ Elegante, glatte Frontfläche
- ✓ Schlankes Design
- ✓ Leistungsstarke Wärmequelle
- ✓ Perfekte Lösung für begrenzte Wandflächen
- ✓ Optionaler hochwertiger Edelstahl-Handtuchhalter

Linienführung, wie sie klarer nicht sein kann. Mit seiner planen Frontfläche verleiht der **Kos V** jedem Raum zeitlose Eleganz. Die abgerundeten, flachen Seitenabdeckungen garantieren, dass die Linienführung von allen Seiten harmonisch wirkt. Er verbindet Funktionalität mit einer klaren, reduzierten Gestaltung und schafft zusätzliche Gestaltungsfreiheit. Hoch. Glatt. Gutes Aussehen. Durch diese Eigenschaften gepaart mit seiner schlanken, vertikalen Bauweise eignet sich der Kos V besonders für moderne Wohnräume und dient als kraftvoller Wärmespender für Räume mit begrenzter Wandfläche.



Anwendungsbereich

Verwendung

Dimensionierung



# Spezifikationen

EIGENSCHAFTEN	EINHEIT	WERTE
ETIM-Klasse		EC011022
Material		Stahl
Typ		20, 21, 22
Oberflächenstruktur		flach glatt
Maximaler Betriebsdruck	bar	10
Anzahl der Standardanschlüsse		4
Wärmeleistung gemäß anerkanntem EN 442-Labor		Ja
Max. Betriebstemperatur	°C	110
Standardfarbe		Ja
Farbe		weiß
RAL-Nummer		9016
Gitter/Abdeckplatte		Ja
Gitter/Abdeckplatte		Ja
Glanzwert		glänzend
Gewindemaß (Zoll)		1/2 Zoll
Gewindeanschluss		Innengewinde
Mit Einpunktanschluss		Ja
Mit Entlüftungsanschluss		Ja
Mit Entlüftungsventil		Ja
Mit Entleerungsmöglichkeit		Ja



# Dokumente

DOKUMENTE	DOKUMENTENTYP	LINK
VN_prospect_convectors_AT	ProductCatalog	<a href="https://asset.productmarketingcloud.com/api/assetstorage/3577_cf92f834-13cb-45b7-9828-42b815b96f12">https://asset.productmarketingcloud.com/api/assetstorage/3577_cf92f834-13cb-45b7-9828-42b815b96f12</a>
General Flat Radiator Installation Instructions	Installation	<a href="https://asset.productmarketingcloud.com/api/assetstorage/3577_764fcaeb-8aae-42e1-aa66-8d098de0bae8">https://asset.productmarketingcloud.com/api/assetstorage/3577_764fcaeb-8aae-42e1-aa66-8d098de0bae8</a>
Installation Guide for KOS V and FARO V Vertical (2024)	Installation	<a href="https://asset.productmarketingcloud.com/api/assetstorage/3577_54aec5f-fb8e-4c27-bc9a-b73fc0077746">https://asset.productmarketingcloud.com/api/assetstorage/3577_54aec5f-fb8e-4c27-bc9a-b73fc0077746</a>
Installation Manual Faro V	TechDia	<a href="https://asset.productmarketingcloud.com/api/assetstorage/3577_6a68539c-c460-4642-8d8b-056f68b79286">https://asset.productmarketingcloud.com/api/assetstorage/3577_6a68539c-c460-4642-8d8b-056f68b79286</a>



# Ressourcen

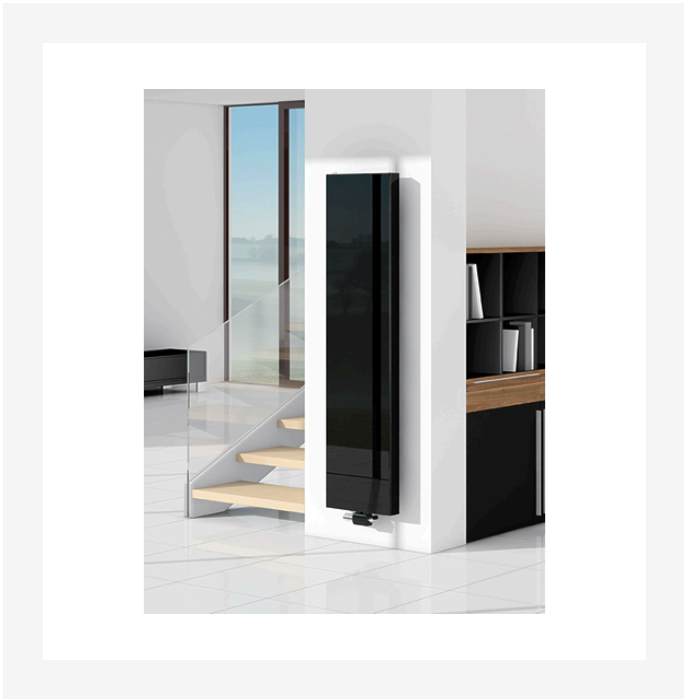

ProductImage - vertikal-plan-mittenanschlussheizkoerper-raum-2



ProductImage - vertikal-plan-mittenanschlussheizkoerper-raum-1

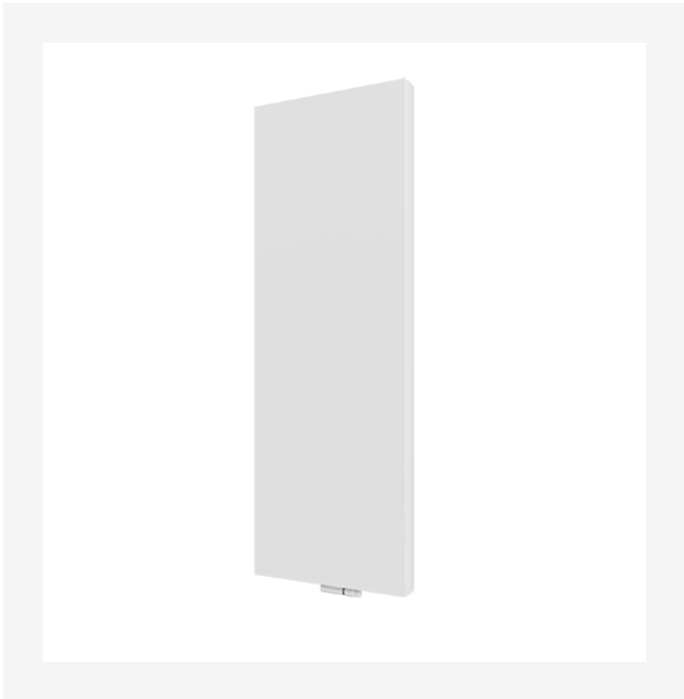

ProductImage - Kos-V\_angle\_right\_web\_480

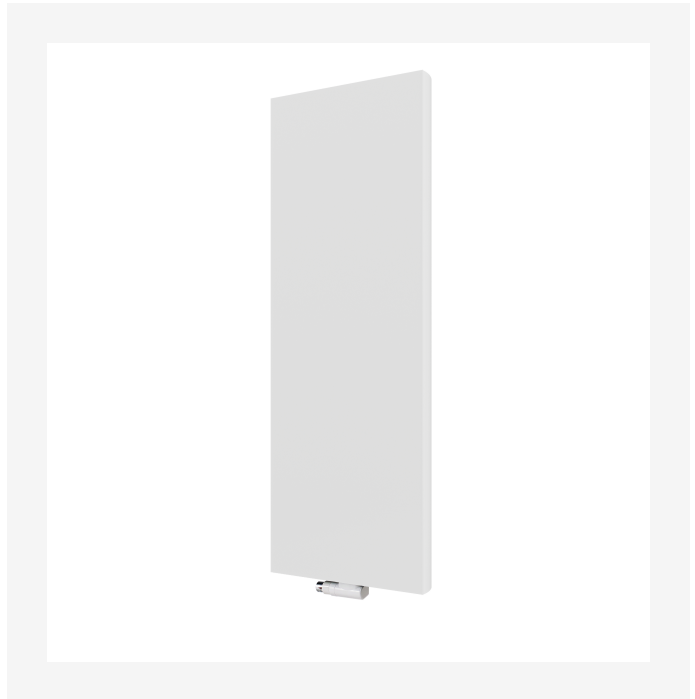

ProductImage - New\_Kos-V main image



# Ressourcen

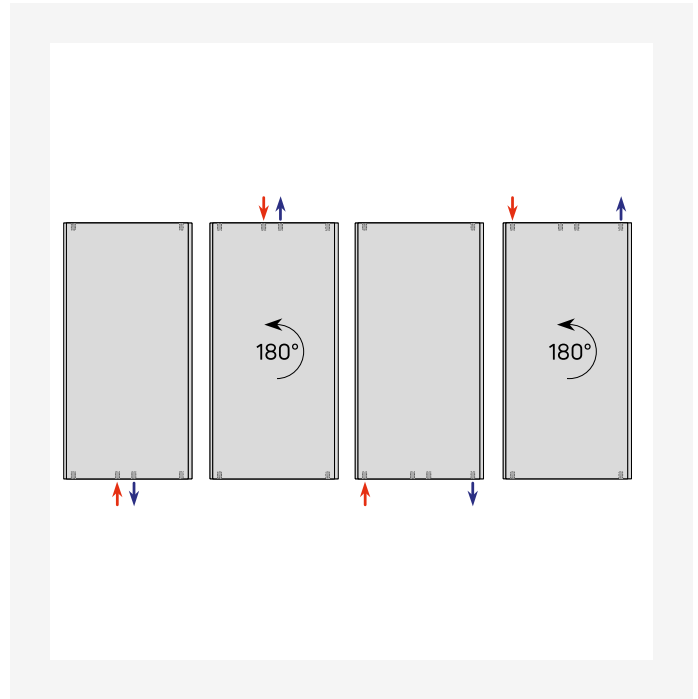

ProductImage - Vertical design radiator Kos V, KOV, 30 degree, white 3D product image.

DimensionalDrawing - Verticals connection options

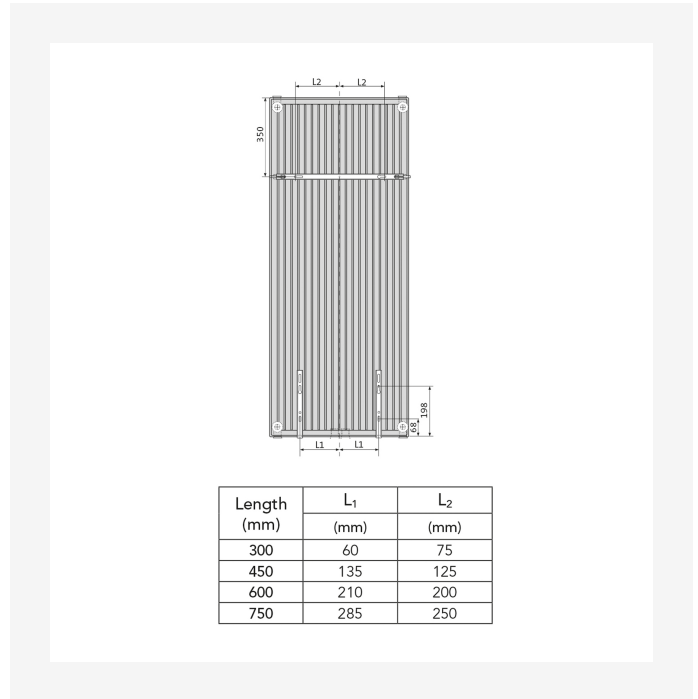
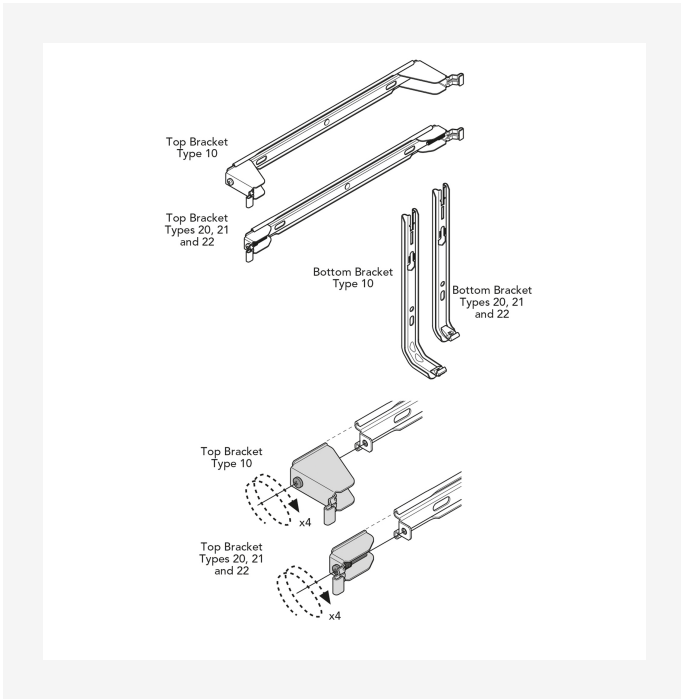

DimensionalDrawing - Myson Vertical, Plan & Plan Plus Vertical Brackets

DimensionalDrawing - Myson Vertical Plan & Plan Plus Vertical - Bracket Positions & Dimensions



# Verwandte Produkte



Handtuchhalter  
Vertikalheizkörper



Handtuchhalter Plan-  
Vertikalheizkörper



Entlüftungsstopfen



Entlüftungsschlüssel

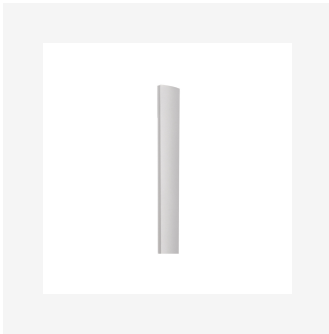

Seitenteil E2-  
Wärmepumpenheizkörper  
Vertikal, links



Thermostatventilkopf



Ventilsets VHX



# 1800

HÖHE 1800 mm	LÄNGE	TIEFE	ARTIKELNUMMER	Systemtemperatur 55/45/20 °C	Systemtemperatur 70/55/20 °C	Systemtemperatur 75/65/20 °C	VOLUMEN (l)	Exponent n	GEWICHT (kg)
<b>Typ 20</b>									
	300	82	FMX2018003011300	459	--	881	4.8	1.28	30.1
	450	82	FMX2018004511300	657	--	1265	7.2	1.28	42.9
	600	82	FMX2018006011300	847	--	1635	9.7	1.29	55.6
	750	82	FMX2018007511300	1031	--	1996	12.1	1.29	0.0
<b>Typ 21</b>									
	300	82	FMX2118003011300	495	--	955	4.8	1.29	31.7
	450	82	FMX2118004511300	716	--	1389	7.2	1.30	45.8
	600	82	FMX2118006011300	930	--	1812	9.7	1.31	59.9
	750	82	FMX2118007511300	1139	--	2228	12.1	1.31	74.0
<b>Typ 22</b>									
	300	107	FMX2218003011300	592	--	1148	4.8	1.30	35.1
	450	107	FMX2218004511300	873	--	1698	7.3	1.30	50.6
	600	107	FMX2218006011300	1149	--	2242	9.7	1.31	66.1
	750	107	FMX2218007511300	1421	--	2781	12.2	1.31	79.8



# 1950

HÖHE 1950 mm	LÄNGE	TIEFE	ARTIKELNUMMER	Systemtemperatur 55/45/20 °C	Systemtemperatur 70/55/20 °C	Systemtemperatur 75/65/20 °C	VOLUMEN (l)	Exponent n	GEWICHT (kg)
<b>Typ 20</b>									
	300	82	FMX2019503011300	495	--	949	5.2	1.28	32.5
	450	82	FMX2019504511300	709	--	1364	7.8	1.28	45.9
	600	82	FMX2019506011300	914	--	1763	10.4	1.29	59.3
	750	82	FMX2019507511300	1113	--	2152	13.0	1.29	72.8
<b>Typ 21</b>									
	300	82	FMX2119503011300	521	--	1008	5.2	1.29	34.1
	450	82	FMX2119504511300	756	--	1466	7.8	1.30	49.3
	600	82	FMX2119506011300	985	--	1913	10.4	1.30	64.4
	750	82	FMX2119507511300	1207	--	2351	13.0	1.31	79.6
<b>Typ 22</b>									
	300	107	FMX2219503011300	624	--	1208	5.3	1.29	37.3
	450	107	FMX2219504511300	922	--	1788	7.8	1.30	53.8
	600	107	FMX2219506011300	1213	--	2360	10.4	1.30	70.3
	750	107	FMX2219507511300	1500	--	2928	13.1	1.31	85.9



# 2100

HÖHE 2100 mm	LÄNGE	TIEFE	ARTIKELNUMMER	Systemtemperatur 55/45/20 °C	Systemtemperatur 70/55/20 °C	Systemtemperatur 75/65/20 °C	VOLUMEN (l)	Exponent n	GEWICHT (kg)
<b>Typ 20</b>									
	300	82	FMX2021003011300	532	--	1016	5.6	1.27	34.8
	450	82	FMX2021004511300	761	--	1459	8.4	1.27	49.8
	600	82	FMX2021006011300	980	--	1886	11.1	1.28	64.8
	750	82	FMX2021007511300	1191	--	2302	13.9	1.29	79.8
<b>Typ 21</b>									
	300	82	FMX2121003011300	548	--	1060	5.6	1.29	36.5
	450	82	FMX2121004511300	796	--	1542	8.4	1.29	52.7
	600	82	FMX2121006011300	1038	--	2012	11.1	1.30	69.0
	750	82	FMX2121007511300	1276	--	2473	13.9	1.30	85.2
<b>Typ 22</b>									
	300	107	FMX2221003011300	655	--	1265	5.7	1.29	40.4
	450	107	FMX2221004511300	967	--	1872	8.4	1.29	58.0
	600	107	FMX2221006011300	1273	--	2471	11.2	1.30	75.6
	750	107	FMX2221007511300	1574	--	3066	13.9	1.30	92.3