

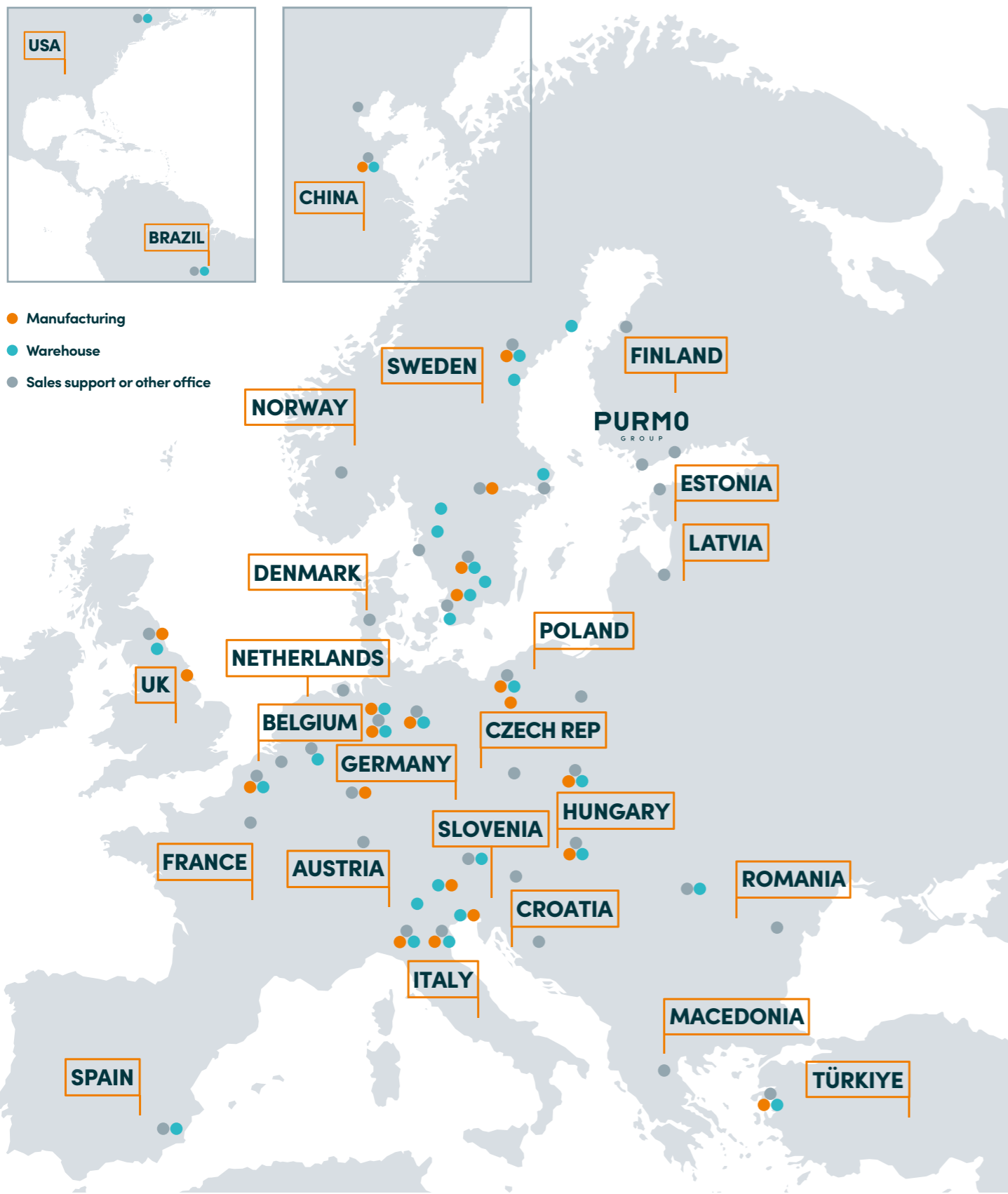

Complete heating solutions 2024

Issue 1.1



Manufacturing in 12 countries	Customers in 100+ countries	Operations in 24 countries
---	---------------------------------------	--------------------------------------

PURMO

GROUP

Purmo Group is Europe's Leader in sustainable indoor climate comfort solutions

Our heating and cooling systems are designed to offer the highest levels of comfort and efficiency.

Our vision

Comfort delivered is our promise to all our stakeholders. It's all about our dedication and our ability to deliver. About listening and responding to the needs of our personnel, our customers and end users.

Purmo Group delivers comfort by doing things smarter, by always moving forward, and by staying ahead of the competition.

We will drive the future of complete heating, cooling and ventilation solutions through state-of-the-art innovation – and we will continuously endeavour to ensure this is done in sustainable ways.

We are Purmo Group – Comfort delivered.



We have a clear sustainability strategy, in line with the UN Sustainable Development Goals (SDGs) and the Paris Climate Agreement. To make change happen and ensure it's rapid, continuous and meaningful, we've set up a clear roadmap. This will guide us towards a sustainable future via touchpoint goals in four focus areas: **our production, our solutions, our people** and **our communities**. Within these areas our ambitions are linked to 10 commitments, which in turn are associated to well-designed actions and projects.

Our 10 commitments

We have set up these 10 commitments as our reference points along our journey to integrate sustainability in every part of our business.



Contents

Heat emitter product selector **8**

Panel radiators **15**

PREMIER HE	16	VERTICAL	32
PREMIER METRIC	16	LST	38
SELECT COMPACT	26	LST VERTICAL	38

Premium panel radiators **47**

PLAN	48	KOS V	70
PLAN PLUS	48	FARO V	70
T6 COMPACT	54	PAROS V	70
T6 PLAN	54	TINOS V	70
ULOW-E2	64		

Design radiators **81**

COLUMN	82	OPUS	98
DÉCOR	88		

Towel warmers **103**

Contemporary	104	DEE	122
TOPAZ	106	INN	124
FATALA	108	SAXBY	125
INTERLUDE	109	THIRLMERE	126
KASAI	110	ULLSWATER	127
MARANOVA	112	Multi-rail	128
MERSEY	114	AVONMORE	130
OUSE	115	ANGARA	132
SOKOTO	116	FERLO	134
STOUR	117	LINDI	136
Traditional	118	TYNE	138
AWE	120	TOWEL WARMERS	
BUTTERMERE	121	ACCESSORIES	140

Fan convectors **143**

KICKSPACE®	144	LO-LINE RC	150
HI-LINE RC	150	IVECTOR S2	156
HI-LINE LV	150		

Underfloor heating **171**

FIXING SYSTEMS	176	CONTROLS	192
PIPE	188	SINGLE ROOM PACKS	200

Electric heating **205**

KICKSPACE® ELECTRIC	144	ELECTRIC COLUMN	214
FINESSE	206	ELECTRIC AVONMORE	216
RIO COMPACT PLUS	208	TAMAR	218
RIO PLAN PLUS	208	INNOKO	220
RIO LINEA PLUS	208	ELECTRIC UNDERFLOOR HEATING	222
ELECTRIC DÉCOR	212		

Heating valves **225**

MATCHMATE	226	LST TRV KITS	242
MATCHMASTER	228	REMOTE THERMOSTATS	244
FULLFLOW	230	AUTOMATIC BYPASS VALVES	246
DECORATIVE TRV	232	HEATING VALVES ACCESSORIES	247
DECORATIVE SLIMLINE, MODERN & TRADITIONAL	234	ELECTRONIC THERMOSTATIC HEAD	247
TRV2	236		
PETITE TRV	238		
MYSON PLUS TRV	240		

Electronic controls **249**

UNISENZA DIAL	250	TOUCH4	257
UNISENZA DIGITAL	251	UNISENZA PLUS	258
UNISENZA WiFi	252	MEP1C, MEP2C, MEP3C & MEPTWOZONE	260
MCT1	253	CONTROL PACKS	261
MPRT	254	MOTORISED VALVES & ACCESSORIES	262
TOUCH	255		
TOUCH2 WiFi	256		

General Information	264	Product Warranty	269
Colour Options	266	Index	270
Heat Output Calculation	268		

For prices please refer to your local stockist or contact our Customer Services team on **0330 041 5474**.

Our promise

Comfort delivered

The indoors. The place where we spend so much time – learning, sleeping, relaxing, sharing. It's where we live. That's why a healthy and comfortable indoor climate is so important. But in a world facing climate challenges, unprecedented population growth and a need to use resources better, ensuring sustainability is paramount.

Committed to innovation, we take a system and solution approach to delivering optimal heating and cooling that offers the highest levels of comfort and energy efficiency. With our complete range and expert knowledge, we can help you find exactly the right solution – whether you're a planner, installer, wholesaler or homeowner. So, let's work together and create innovative solutions that will meet tomorrow's indoor climate challenges today. Let's advance indoor climates as we know them.



Comfort

delivered by ...



Which heat emitter is the right one?

Panel radiators (often mixed with underfloor heating) are still the preferred solution for heating. They are a powerful and inexpensive option with many different configurations, sizes, and designs to choose from.

Additionally, there may be special requirements for heat emitters, such as availability of pipework or wall space. These days, aesthetics and design preferences also speak strongly in favour of making the right choice.

Whatever the reason for selection; energy-saving, aesthetics, low temperature or otherwise, MYSON has a solution.

Terms of Reference	Type of Heating Device	Solution from MYSON	Description	Reasons for Use	Style	Suitable for Low Temperature Systems	Smart Heating Control
Modernisation	Panel radiators	Premier HE, Select Compact	Classic panel radiators in a wide range of sizes	High performance, wide range of sizes, models and heat outputs available	Traditional style white panel radiators	✓	
	Premium panel radiators	Plan, Plan Plus	Stylish, sleek front panel radiators, available in horizontal and vertical models	Combines good looks with high performance	Minimalist feel, modern and simple design	✓	
	Designer radiators	Column, Décor, Opus	Fashionable, functional and flexible, décor radiators available in horizontal and vertical models	Great looks and excellent heat outputs	Classical shape	✓	
	Vertical radiators	Vertical, Kos V, Faro V, Tinos V, Paros V, Column, Décor, Opus	Various models; traditional panel, sleek front panel, column and tubular radiators	Modern, space-saving design with high heat outputs	Space-saving, stylish and functional	✓	
	Fan-assisted radiators	Ulow-E2	Built in fans deliver up to 60% more heat than traditional radiators	Rapid heat response when required, and summer breeze function for warm days	Traditional style with additional functionality	✓	
	Underfloor heating	Floortec fixing systems	Wide range of fixing systems and controls to suit any floor type	High performance. Frees up space. Can be combined with other heat emitters	Concealed under floor	✓	
Sophisticated living space design	Vertical radiators	Vertical, Kos V, Faro V, Tinos V, Paros V, Column, Décor, Opus	Various models; traditional panel, sleek front panel, column and tubular radiators	Modern, contemporary designs to suit décor and free up wall space	Space-saving, stylish and functional	✓	
	Designer radiators	Column, Décor, Opus	Fashionable, functional and flexible, available in horizontal and vertical models	Great looks and excellent heat outputs	Classical shape	✓	
	Underfloor heating	Floortec fixing systems	Wide range of fixing systems and controls to suit any floor type	High performance, radiant heating. Frees up space for enhanced interior décor	Concealed under floor	✓	
Bathroom	Contemporary towel warmers	Fatala, Kasai, Interlude, Maranoa, Mersey, Ouse, Sokoto, Stour	Wide range of contemporary models in a choice of finishes and colours	Good looking and highly functional	Attractive designs and colours to suit décor		
	Traditional towel warmers	Awe, Buttermere, Dee, Inn, Saxby, Thirlmere, Ullswater	From simple rails to elaborate designs, this range offers a classic, vintage and elegant feel	Adds a touch of style to the room	Attractive designs in chrome finish		
	Multi-rail towel warmers	Avonmore, Angara, Ferlo, Lindi, Tyne	Simple elegant and practical designs, including straight and curved models	Great looks as well as functional	Attractive designs, most available in white or chrome		
	Bathroom radiator	Topaz	High output double multi-rail towel warmer, ideal for low temperature systems	High heat output combined with modern looks	Ladder style in attractive colours	✓	
	Underfloor heating	Floortec fixing systems	Wide range of fixing systems and controls to suit any floor type	High performance radiant heating. Can be combined with other heat emitters	Concealed under floor	✓	
	Fan convectors	Hi-Line LV	High level, wall-mounted fan convector that utilises unused space above a door	Low voltage model ideally suited to bathrooms where safety matters most	Discreet overhead fan heater		
Allergy sufferers	Tubular radiators	Column	Fashionable, functional and flexible, available in horizontal and vertical models	Easy to clean due to rounded edges and wide distance between tubes, minimises dust	Classical shape	✓	
	Underfloor heating	Floortec fixing systems	Wide range of fixing systems and controls to suit any floor type	Warm surfaces effectively reduce bacteria, mould and mites, low dust turbulence	Concealed under floor	✓	

Terms of Reference	Type of Heating Device	Solution from MYSON	Description	Reasons for Use	Style	Suitable for Low Temperature Systems	Smart Heating Control
Kitchen has limited space	Plinth heaters	Kickspace®	Innovative plinth heater for a discreet space-saving solution where wall space is limited	Frees up wall space and provides rapid heat	Discreetly located under kitchen units		
	Fan convectors	iVector S2	Innovative low water content fan convector with discreet ceiling installation options	Fast and efficient heating, ceiling installation frees up wall space	Unobtrusive, can be ceiling mounted or discreetly recessed in the ceiling	✓	
	Vertical radiators	Vertical, Kos V, Faro V, Tinos V, Paros V, Column, Décor, Opus	Various models; traditional panel, sleek front panel, column and tubular radiators	Modern, space-saving design with high heat output	Space-saving, stylish and functional	✓	
Occasionally used rooms	Electric radiators	Rio Plus, Finesse, Décor, Column	A wide range of electric radiators including standard panel, stylish column and design radiators	Flexible installation option with fast heat reaction	Traditional, modern and contemporary		✓ (Rio Plus)
	Electric towel warmers	Avonmore, Tamar, Innoko	Ideal for occasionally used rooms (range of dual fuel towel warmers also available)	Perfect for small areas like bathrooms, cloakrooms	Stylish designs		
	Fan convectors	iVector S2	Innovative low water content fan convector with flexible installation options	Rapid heat up times with low water content. Can offer both heating and cooling	Unobtrusive, can be surface mounted or recessed	✓	
	Plinth heaters	Kickspace®	Innovative and discreet plinth heater with fast heat response	Frees up wall space and provides rapid heat when required	Discreetly located		
	Temperature controllers	TRV, Electronic Thermostatic Head	Wide range of manual, electronic and decorative thermostatic valves and heads	Controls temperature to reduce wasted energy. ETH enables remote wireless control	Attractive and functional accessories		✓ (ETH)
Cooling in Summer	Smart controls	Unisenza Plus	Solution that allows users to easily connect and control numerous heating and cooling devices	Centralised control of connected devices via an intuitive app, compatible with Android/iOS	Smart heating control		✓
	Fan convectors	iVector S2	Innovative low water content fan convector; can be wall mounted or recessed, ceiling mounted or recessed	Cooling in summer (when combined with a reversible heat pump or cooling source)	Unobtrusive design, can be surface mounted or recessed	✓	
Limited/restricted wall space	Fan-assisted radiators	Ulow-E2	Fans provide gentle air movement to create a pleasant 'summer breeze' effect	Summer breeze function for warm days and rapid heat response in winter	Traditional style with additional functionality	✓	
	Underfloor heating	Floortec fixing systems	Wide range of fixing systems and controls to suit any floor type	High performance, radiant heating. Frees up wall space. Can be combined with other heat emitters	Concealed under floor	✓	
	Vertical radiators	Vertical, Kos V, Faro V, Tinos V, Paros V, Column, Décor, Opus	Various models; traditional panel, sleek front panel, column and tubular radiators	Modern designs with high heat output. Frees up wall space	Space-saving, stylish and functional	✓	
No gas/hot water supply	Fan convectors	iVector S2	Innovative low water content fan convector	Fast and efficient heating, ceiling installation frees up wall space	Ceiling mounted or discreetly recessed	✓	
	Electric radiators	Finesse, Décor, Column	A wide range of electric radiators including standard panel, stylish column and design radiators	Flexible location and easy operation without central heating or pipework	Traditional, modern and contemporary		
	Smart electric radiators	Rio Plus - Compact, Plan and Linea	Modern electric radiators with unique, energy-saving features built in	Flexible location, energy saving and option to control remotely via an app	Modern and contemporary		✓
	Electric towel warmers	Avonmore, Tamar, Innoko	Classic multi-rail and contemporary designs, available in chrome or white	Perfect for small areas like bathrooms, cloakrooms where there is no existing pipework	Stylish designs		
	Electric underfloor heating	MYSON Electric Underfloor	A great alternative for small areas without central heating or existing pipework	Easy to install, perfect for renovations, bathrooms, kitchens and conservatories	Concealed under floor	✓	
Healthcare/Educational facility	Low Surface Temperature radiators	LST - Vertical and Horizontal	Low surface temperature radiators coated with antibacterial paint	Complies with NHS Estates Guidance Notes 1998	Safety-conscious round steel casing, no sharp edges, pipework is concealed		
	Underfloor heating	Floortec fixing systems	Wide range of fixing systems and controls to suit any installation	Efficient heating solution without the risk of injury in healthcare and educational facilities	Concealed under floor	✓	
	Fan convectors	iVector S2	Innovative low water content fan convector; can be ceiling mounted or recessed	Fast and efficient heating, safely installed in or on the ceiling	Modern and discreet	✓	

Our commercial brand house is an overview of our vision and customer promise. The four brand pillars demonstrate how we plan to achieve this and define the change we want to drive.

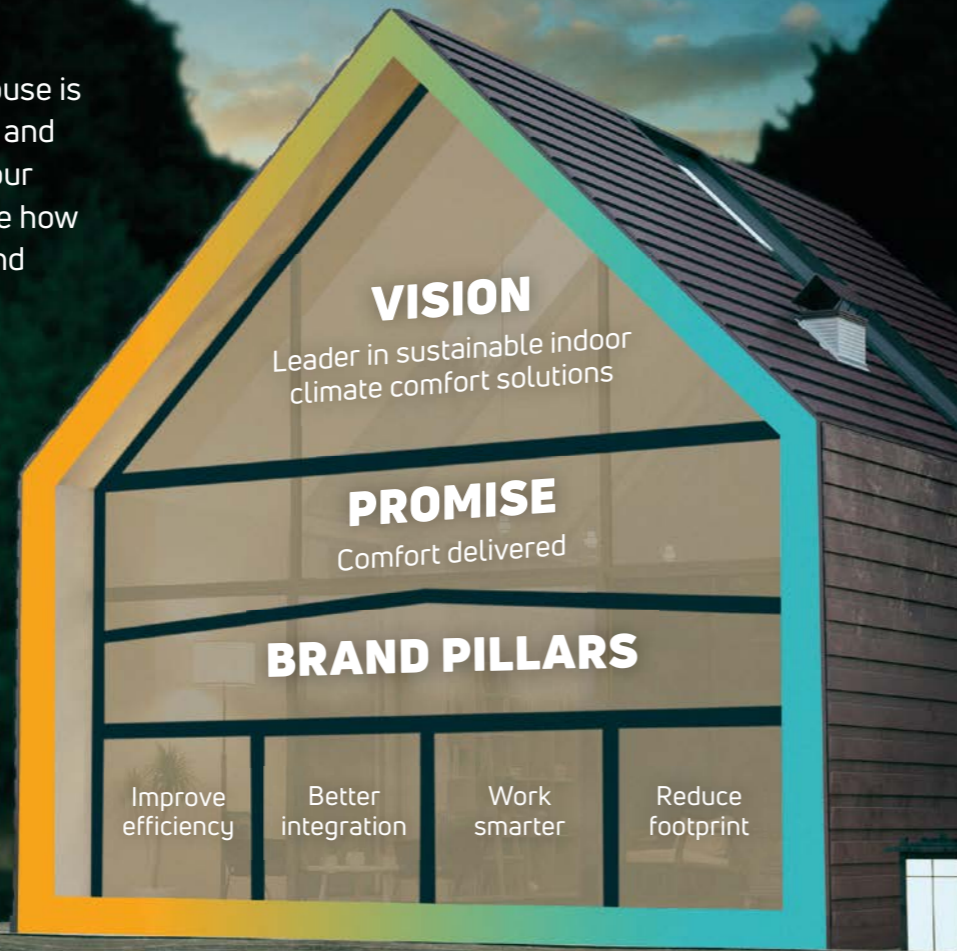

Improve efficiency

Optimise energy efficiency through system accuracy

Better integration

Let's **integrate solutions** in innovative systems for better performance

Work smarter

Let's work together and **work smarter**

Reduce footprint

Let's focus on the full product life cycle and **reduce impact on our climate**

Sustainable indoor climate comfort solutions **without compromise**

MYSON provides complete, industry-leading solutions for hydronic, electrical and air-based heating and cooling systems.

We go beyond single products and components to offer an extensive portfolio that combines innovative design, R&D insight, extensive technical know-how and industry expertise. Our decades of experience enables us to offer integrated system designs which maximise comfort and minimise energy use, so that net zero becomes feasible without compromising indoor climate comfort.

The big picture

By delivering complete solutions we can offer indoor climate comfort that takes multiple aspects of performance optimisation into account and ensures that our solutions match customer needs.

This approach enables us to deliver higher energy efficiency, eg, by combining low temperature heat emitters with underfloor heating, we can deliver an optimal balance between swift changes in room temperatures and energy efficiency.

As one of the UK's leading brands, MYSON has made a commitment to help reduce CO₂ emissions with an extensive portfolio of solutions that enable you to balance the need for better indoor climate comfort with lower energy consumption, through market-leading, innovative eco-friendly technology.

With our broad range of low temperature heating products we can support the current changes to the building regulations and help to deliver net zero in the UK, starting with a 30% reduction of CO₂ emissions for new build homes.

- We optimise energy efficiency through system accuracy.
- We integrate solutions in innovative systems for better performance and lower energy consumption.
- We focus on reducing our ecological footprint in all aspects of our operations.

MYSON products are compatible with all heat sources and renewable energy sources. This is your guarantee of an economically and ecologically efficient heating solution.

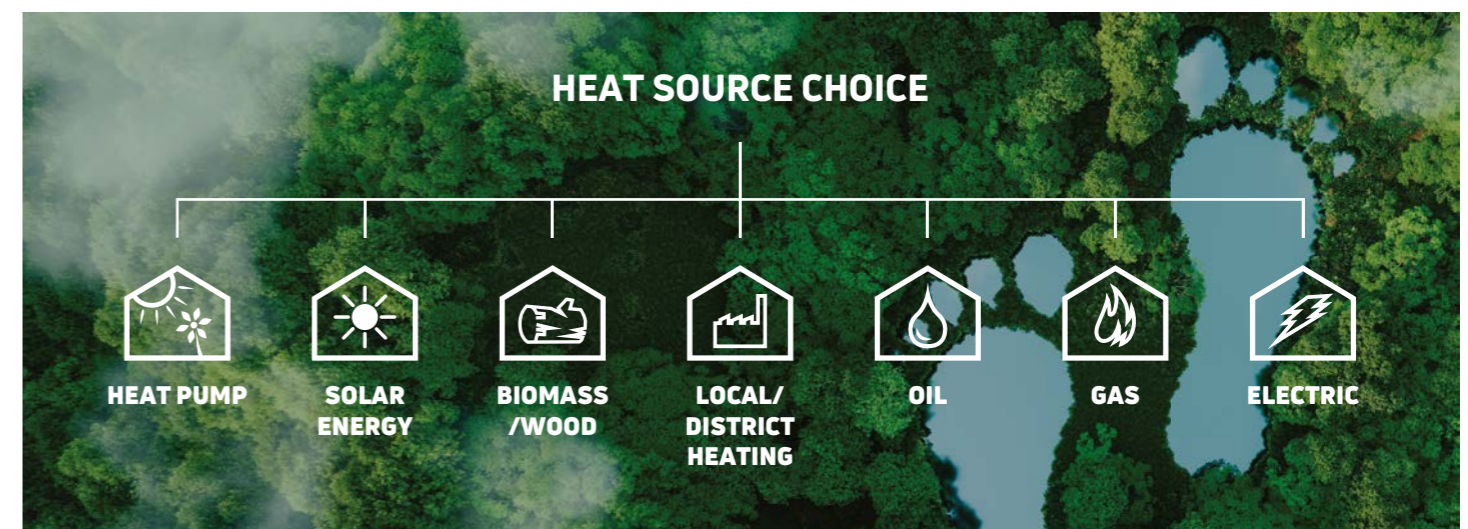



The UK's only total solutions provider

MYSON's expertise in the design, development and manufacture of heat emitters goes back over 50 years, making us one of the most trusted, reliable and innovative heat emitter manufacturers in Europe.

As the UK's only total heating solutions provider, MYSON is in a unique position to offer unbiased advice on the most effective indoor climate solutions, integrating mixed system layouts for maximum efficiency.

Our representatives are always there to make selecting our products easier for you, and our customer support team are on hand, ready to provide assistance when you might need it.



TECHNICAL SUPPORT

With years of knowledge about our products, our technical support team is here to assist with anything from practical support and advice to where to install our products.



DESIGN SERVICES

Our systems and solutions experts have years of experience in designing heating plans and we offer a full and complete design service for all our products, tailored to individual needs, that includes mixed system layouts.



BIM

Our core range of products are available to download via Bimstore, as well as the MYSON website, making it even easier to specify our products.



TRAINING

MYSON offers training workshops for installers or developers to show how easy it is to install our underfloor heating systems.





Panel radiators

MYSON has been manufacturing traditional steel panel radiators in the UK for over 60 years. Our experience and expertise in this area makes us one of the most trusted, reliable and innovative heating solutions providers in Europe. The range includes classics from our respected SELECT and PREMIER ranges, space saving solutions with the VERTICAL and safety products, such as the LST - available in horizontal and vertical models.

Our SELECT and PREMIER ranges include single, double, double panel extra and compact models, and we also have a range of triple panels within our SELECT COMPACT range.



MYSON's PREMIER range sets the benchmark for panel radiators in the UK market. As the only UK panel radiator range offering imperial fitting dimensions, MYSON's PREMIER HE round top radiator is the perfect panel radiator for retro fitting projects. The PREMIER METRIC has the same stylish round top but offers metric equivalent sizes.

- Stylish and hazard reducing round top design
- Manufactured in the UK to the highest production standards
- Impressive heat outputs at low energy consumption
- Extensive range of size options



PREMIER HE & PREMIER METRIC

PREMIER HE

PREMIER HE

General specification & technical information

-  **CERTIFICATION**
Manufactured and tested to BS EN 442 & EN 442. Carries the BS Kitemark, CE & UKCA Mark. Produced under a quality management system - ISO 9001:2015, environmental management system - ISO 14001:2015 and Occupational health and safety management system - ISO 45001:2018.
-  **AIR VENTS**
Unique integral air vent situated top right corner of panel, on the 2 tap models only.
-  **OPERATING PRESSURES**
Tested to a pressure of 7 bar. Working pressure of up to 5.4 bar.
-  **OPERATING TEMPERATURE**
Maximum 100°C.
-  **DELIVERY**
2 - 5 working days. Non-stocked items: 2 - 3 weeks.
-  **VALVES**
Please see page 225.
-  **BIM**
Visit our website to download the BIM components www.myson.co.uk/bim
-  **GUARANTEE**
10 year guarantee from date of purchase against manufacturing defects.
-  **COLOUR**
All radiators are de-greased, phosphated and primer coated. An epoxy polyester finishing coat in white (RAL 9016) is applied to all front and rear surfaces.
-  **ACCESSORIES**
Touch up paint is available to order.
-  **SYSTEM**
2 pipe pumped indirect domestic and commercial heating applications.
-  **CONNECTIONS**
2 x 1/2" BSP as standard. Selected sizes available with 4 x 1/2" BSP, please see below.

For more general information, please see page 264.

Weights & water contents per metre length

Type		Nominal Height (in)							
		12		15		21		27	
		Weight (kg)	Water Content (l)	Weight (kg)	Water Content (l)	Weight (kg)	Water Content (l)	Weight (kg)	Water Content (l)
11	SC	8.2	2.8	10.6	3.2	14.7	4.0	19.3	5.1
21	DPX	-	-	18.0	6.4	24.7	8.3	32.4	9.9
22	DC	16.3	5.8	20.7	6.4	29.1	8.3	38.2	9.9

n-Coefficients

Type		Nominal Height (in)			
		12	15	21	27
11	SC	1.2692	1.2728	1.2783	1.3079
21	DPX	-	1.2850	1.2995	1.3136
22	DC	1.2825	1.2988	1.3241	1.3246

Connection options

2 x 1/2" BSP
4 x 1/2" BSP

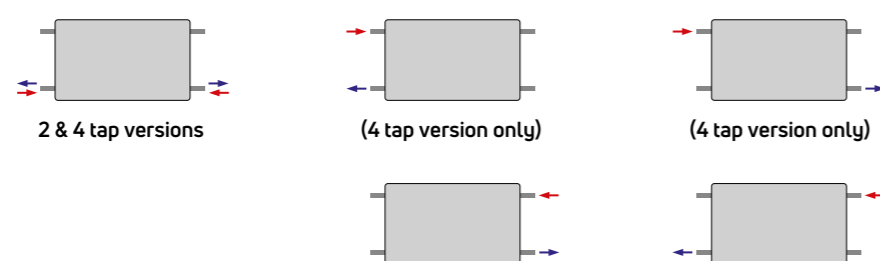

Mounting positions, dimensions & wall brackets

2 connections*

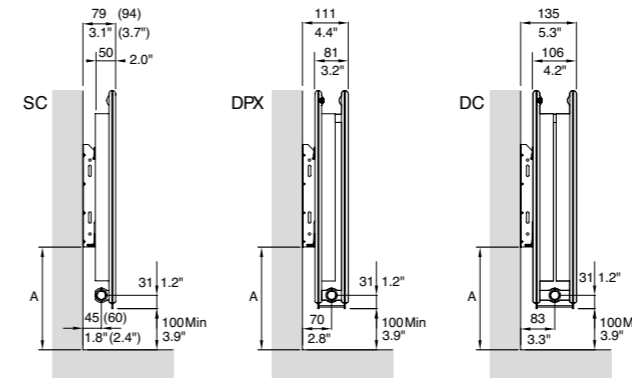

Nominal Height (in)	A		B	
	(in)	(mm)	(in)	(mm)
12	6.65	170	N/A	N/A
15	6.93	177	13.2	335
21	9.81	250	18.7	475
27	16.10	410	25.0	635

4 connections**

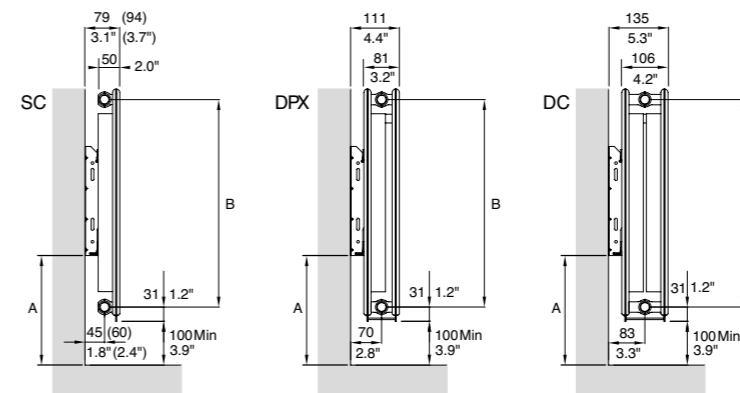

12" Wall Bracket***

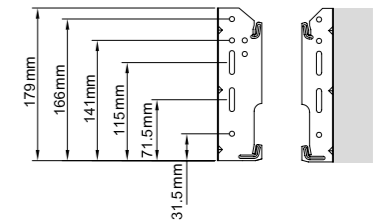

15/21/27" Wall Bracket***

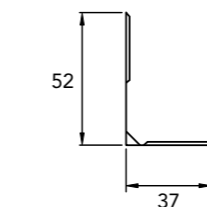
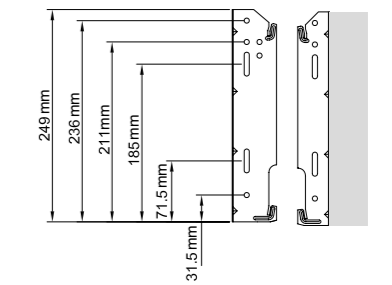

Bracket Plan View

N.B. Figures in brackets apply when hanging with long leg.
Long leg suitable for hanging Type 11 (SC) radiators only.
Short leg suitable for radiator Types 11, 21 & 22.

*Available for full range
**Available for selected sizes
***Security clip available on request

NB: All measurements are nominal.

Bracket positions & dimensions

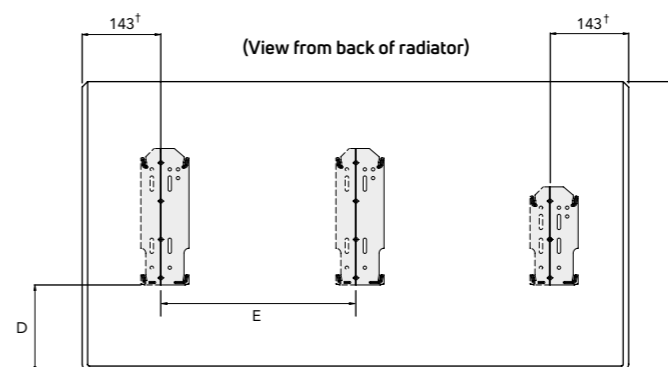

Nominal Height (in)	C		D	
	(in)	(mm)	(in)	(mm)
12	11.8	300	2.75	70
15	15.4	390	3.03	77
21	20.9	530	5.91	150
27	27.2	690	12.20	310

Nominal Length (in)	E	
	(in)	(mm)
77	34	864
79	35	889
85	38	965

N.B. Radiators up to and including 69" long have two brackets. Radiators 77" and longer have three brackets. The position of the centre bracket is given in the table.

† 118mm from each end for 11" (286mm) long radiators only.

PREMIER HE

Heat outputs

Single Convector Type 11



Nominal Height	Nominal Length (inches - mm)	No. of sections	
12 inch (300mm)	15 - 400	8	
	31 - 800	16	
	47 - 1200	24	
	63 - 1600	32	
	79 - 2000	40	
15 inch (390mm)	21 - 540	11	
	25 - 641	13	
	29 - 743	15	
	37 - 946	19	
	41 - 1047	21	
	45 - 1149	23	
	49 - 1251	25	
	53 - 1352	27	
	57 - 1454	29	
	61 - 1556	31	
	69 - 1759	35	
	77 - 1962	39	
	85 - 2165	43	
21 inch (530mm)	17 - 438	9	
	21 - 540	11	
	25 - 641	13	
	29 - 743	15	
	33 - 844	17	
	37 - 946	19	
	41 - 1047	21	
	45 - 1149	23	
	49 - 1251	25	
	53 - 1352	27	
	57 - 1454	29	
	61 - 1556	31	
	69 - 1759	35	
	77 - 1962	39	
	85 - 2165	43	
	27 inch (690mm)	11 - 286	6
		17 - 438	9
21 - 540		11	
25 - 641		13	
29 - 743		15	
33 - 844		17	
37 - 946		19	
41 - 1047		21	
45 - 1149		23	
53 - 1352		27	
61 - 1556		31	
69 - 1759		35	

Heat Outputs @ ΔT 50°C		Heat Outputs @ ΔT 30°C		Order Code
Watts	Btu/h	Watts	Btu/h	
199	680	104	356	12 SC 15
409	1395	214	730	12 SC 31
618	2109	323	1103	12 SC 47
828	2824	433	1477	12 SC 63
354	1207	185	630	15 SC 21
420	1433	219	748	15 SC 25
487	1661	254	867	15 SC 29
620	2114	323	1104	15 SC 37†
686	2342	358	1222	15 SC 41†*
753	2568	393	1340	15 SC 45†*
819	2796	428	1459	15 SC 49†*
886	3024	463	1578	15 SC 53†*
952	3249	497	1696	15 SC 57
1019	3477	532	1815	15 SC 61
1152	3931	601	2052	15 SC 69
1285	4385	671	2289	15 SC 77
375	1281	195	667	21 SC 17†
463	1579	241	822	21 SC 21†
549	1874	286	976	21 SC 25†
637	2173	331	1131	21 SC 29†
724	2471	377	1286	21 SC 33†
811	2766	422	1440	21 SC 37†
898	3064	467	1595	21 SC 41†
985	3360	513	1749	21 SC 45†
1072	3658	558	1904	21 SC 49†
1160	3956	604	2059	21 SC 53†
1246	4252	649	2213	21 SC 57†
1333	4550	694	2368	21 SC 61†*
1507	5143	785	2677	21 SC 69†*
1681	5737	875	2986	21 SC 77
1855	6331	966	3295	21 SC 85
305	1042	157	534	27 SC 11†
468	1596	240	818	27 SC 17†
577	1968	296	1009	27 SC 21†
685	2336	351	1198	27 SC 25†
794	2708	407	1388	27 SC 29†
902	3079	463	1579	27 SC 33†
1010	3447	518	1767	27 SC 37†
1119	3819	574	1958	27 SC 41†
1227	4187	629	2147	27 SC 45†
1445	4930	741	2528	27 SC 53
1662	5670	852	2907	27 SC 61
1879	6410	963	3286	27 SC 69

Double Panel "Xtra" Type 21

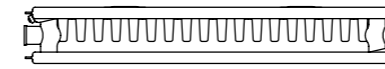

Heat Outputs @ ΔT 50°C		Heat Outputs @ ΔT 30°C		Order Code
Watts	Btu/h	Watts	Btu/h	
723	2467	375	1279	15 DPX 29
920	3141	477	1629	15 DPX 37†*
1020	3479	529	1805	15 DPX 41†*
1118	3815	580	1979	15 DPX 45†*
1217	4153	631	2154	15 DPX 49†*
1316	4492	683	2330	15 DPX 53†*
1415	4827	734	2504	15 DPX 57†*
1514	5166	785	2680	15 DPX 61
1712	5840	888	3029	15 DPX 69
1909	6514	990	3379	15 DPX 77
550	1876	283	966	21 DPX 17†*
678	2312	349	1191	21 DPX 21†
804	2745	414	1413	21 DPX 25†
932	3182	480	1638	21 DPX 29†
1060	3618	546	1863	21 DPX 33†
1187	4051	611	2086	21 DPX 37†
1315	4488	677	2311	21 DPX 41†
1442	4920	742	2533	21 DPX 45†
1570	5357	808	2758	21 DPX 49†*
1698	5794	874	2983	21 DPX 53†
1825	6226	940	3206	21 DPX 57
1953	6663	1005	3431	21 DPX 61
2208	7532	1137	3878	21 DPX 69
2462	8401	1268	4326	21 DPX 77
687	2343	351	1198	27 DPX 17†
847	2889	433	1477	27 DPX 21†
1005	3429	514	1753	27 DPX 25†
1165	3975	596	2032	27 DPX 29†
1325	4521	677	2311	27 DPX 33†
1483	5061	758	2587	27 DPX 37†
1643	5607	840	2866	27 DPX 41
1802	6147	921	3142	27 DPX 45
2122	7239	1084	3700	27 DPX 53
2440	8325	1247	4255	27 DPX 61

Double Convector Type 22

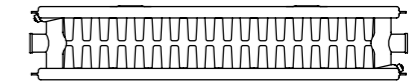













Heat Outputs @ ΔT 50°C		Heat Outputs @ ΔT 30°C		Order Code
Watts	Btu/h	Watts	Btu/h	
795	2712	413	1408	12 DC 31
1201	4098	624	2129	12 DC 47
1609	5489	835	2851	12 DC 63
2015	6875	1047	3571	12 DC 79
675	2303	348	1186	15 DC 21
801	2734	413	1408	15 DC 25
929	3169	478	1632	15 DC 29†
1183	4035	609	2078	15 DC 37†
1310	4470	675	2302	15 DC 41†
1436	4900	740	2524	15 DC 45†*
1564	5336	805	2748	15 DC 49†*
1691	5771	871	2972	15 DC 53†*
1818	6201	936	3194	15 DC 57
1945	6636	1002	3418	15 DC 61
2199	7502	1133	3864	15 DC 69
2453	8368	1263	4310	15 DC 77
2706	9234	1394	4756	15 DC 85
706	2411	359	1226	21 DC 17†
871	2972	443	1511	21 DC 21†
1034	3528	526	1794	21 DC 25†
1198	4089	609	2079	21 DC 29†
1363	4651	693	2365	21 DC 33†
1526	5206	776	2647	21 DC 37†
1690	5768	859	2933	21 DC 41†
1853	6324	942	3215	21 DC 45†
2018	6885	1026	3501	21 DC 49†
2182	7446	1110	3786	21 DC 53†*
2345	8002	1192	4069	21 DC 57
2510	8564	1276	4354	21 DC 61
2837	9681	1443	4922	21 DC 69
3165	10798	1609	5490	21 DC 77
3492	11915	1776	6058	21 DC 85
572	1951	291	992	27 DC 11†
876	2987	445	1519	27 DC 17†
1079	3683	549	1872	27 DC 21†
1281	4372	651	2222	27 DC 25†
1485	5068	755	2576	27 DC 29†
1689	5763	859	2930	27 DC 33†
1891	6452	961	3280	27 DC 37†
2095	7148	1065	3633	27 DC 41†
2297	7837	1168	3984	27 DC 45†
2705	9228	1375	4691	27 DC 53
3110	10613	1581	5395	27 DC 61
3516	11997	1787	6099	27 DC 69

†Available as a 4 tap option.

†* 4 Tap option available. Non-stock - made to order only.

PREMIER METRIC

General specification & technical information

-  **CERTIFICATION**
Manufactured and tested to BS EN 442 & EN 442. Carries the BS Kitemark, CE & UKCA Mark. Produced under a quality management system - ISO 9001:2015, environmental management system - ISO 14001:2015 and Occupational health and safety management system - ISO 45001:2018.
-  **GUARANTEE**
10 year guarantee from date of purchase against manufacturing defects.
-  **COLOUR**
All radiators are de-greased, phosphated and primer coated. An epoxy polyester finishing coat in white (RAL 9016) is applied to all front and rear surfaces.
-  **ACCESSORIES**
Touch up paint is available to order.
-  **SYSTEM**
2 pipe pumped indirect domestic and commercial heating applications.
-  **CONNECTIONS**
4 x 1/2" BSP. Please see below.
-  **AIR VENTS**
Air vent and plug packs are included in the packaging.
-  **OPERATING PRESSURES**
Tested to a pressure of 7 bar. Working pressure of up to 5.4 bar.
-  **OPERATING TEMPERATURE**
Maximum 100°C.
-  **DELIVERY**
2 - 5 working days. Non-stocked items: 2 - 3 weeks.
-  **VALVES**
Please see page 225.
-  **BIM**
Visit our website to download the BIM components www.myson.co.uk/bim

For more general information, please see page 264.

Weights & water contents per metre length

Type		Nominal Height (mm)							
		300		450		600		700	
		Weight (kg)	Water Content (l)	Weight (kg)	Water Content (l)	Weight (kg)	Water Content (l)	Weight (kg)	Water Content (l)
11	SC	8.3	2.8	12.4	3.4	16.7	4.1	19.6	4.9
21	DPX	14.3	5.7	20.9	6.7	28.0	8.3	32.5	9.9
22	DC	17.1	5.7	24.2	6.7	32.8	8.3	38.2	9.9

n-Coefficients

Type		Nominal Height (mm)			
		300	450	600	700
11	SC	1.2692	1.2751	1.2913	1.3098
21	DPX	1.2757	1.2912	1.3057	1.3145
22	DC	1.2825	1.3096	1.3243	1.3246

Connection options

4 x 1/2" BSP

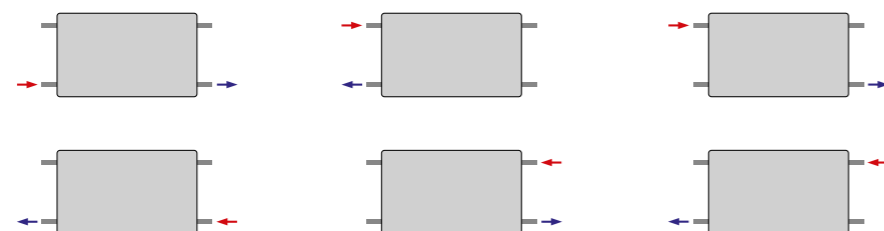

Mounting positions, dimensions & wall brackets

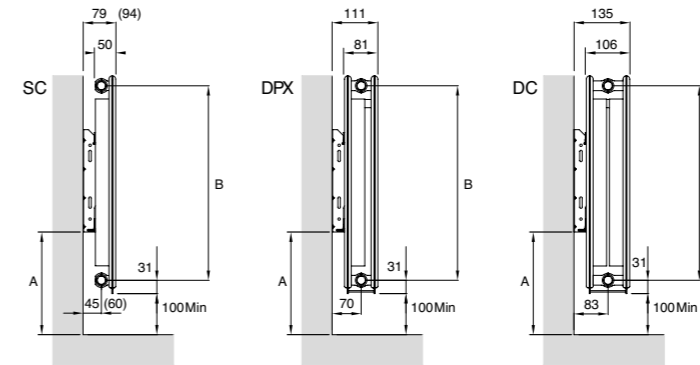

Nominal Height (mm)	A (mm)	B (mm)
	300	170
450	237	393
600	320	543
700	410	643

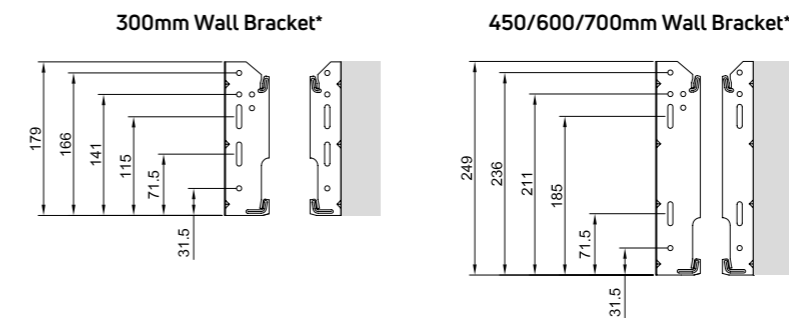

Bracket Plan View

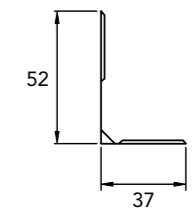

N.B. Figures in brackets apply when hanging with long leg.
Long leg suitable for hanging Type 11 (SC) radiators only. Short leg suitable for radiator Types 11, 21 & 22.

*Security clip available on request

NB: All measurements are nominal.

Bracket positions & dimensions

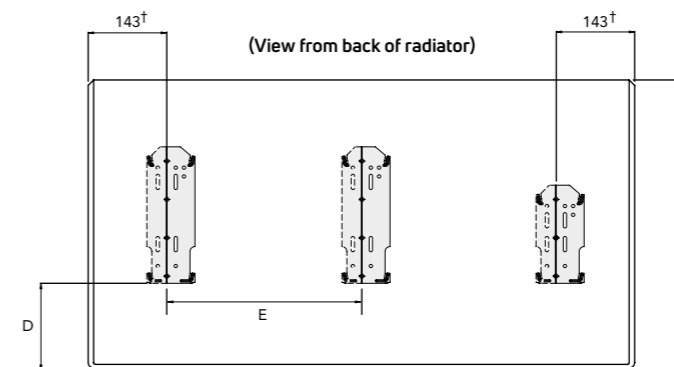

Nominal Height (mm)	C (mm)	D (mm)
	300	300
450	450	137
600	600	220
700	700	310

Nominal Length (mm)	E (mm)
	1800
2000	864
2200	965
2400	1067
2600	1168
2800	1270
3000	1372

N.B. Radiators up to and including 1600mm long have two brackets. Radiators 1800mm and longer have three brackets. The position of the centre bracket is given in the table.

† 118mm from each end for 300mm long radiators only.















The SELECT COMPACT is the ultimate in radiator design. It uses a 33mm pitch, which our years of manufacturing expertise and research have established to be the optimum design for a Compact radiator. The SELECT COMPACT delivers impressive outputs whilst using a low water temperature.

- Our most extensive range, the SELECT COMPACT is available in 222 different sizes
- It comes in four types; single convector, double convector, double panel extra and triple convector type radiator, all with factory fitted top grille and side panels as standard
- There are six different heights ranging from 300mm to 900mm
- We offer lengths from 300mm to 2400mm



SELECT COMPACT

General specification & technical information

-  **CERTIFICATION**
Manufactured and tested to BS EN 442 & EN 442. Carries the BS Kitemark, CE & UKCA Mark. Produced under a quality management system - ISO 9001:2015, environmental management system - ISO 14001:2015 and Occupational health and safety management system - ISO 45001:2018.
-  **GUARANTEE**
10 year guarantee from date of purchase against manufacturing defects.
-  **COLOUR**
All radiators are de-greased, phosphated and primer coated. An epoxy polyester finishing coat in white (RAL 9016) is applied to all front and rear surfaces.
-  **ACCESSORIES**
Touch up paint is available to order.
-  **SYSTEM**
2 pipe pumped indirect domestic and commercial heating applications.
-  **CONNECTIONS**
4 x 1/2" BSP. Please see below.
-  **AIR VENTS**
Air vent and plug packs are included in the packaging.
-  **OPERATING PRESSURES**
Tested to a pressure of 10.5 bar. Working pressure of up to 8.0 bar.
-  **OPERATING TEMPERATURE**
Maximum 100°C.
-  **DELIVERY**
2 - 5 working days. Non-stocked items: 3 - 4 weeks.
-  **VALVES**
Please see page 225.
-  **BIM**
Visit our website to download the BIM components www.myson.co.uk/bim

For more general information, please see page 264.

Weights & water contents per metre length

Type	SS	Nominal Height (mm)											
		300		400		500		600		750		900	
		Weight (kg)	Water Content (l)	Weight (kg)	Water Content (l)	Weight (kg)	Water Content (l)	Weight (kg)	Water Content (l)	Weight (kg)	Water Content (l)	Weight (kg)	Water Content (l)
11	SS	9.0	1.4	12.1	2.2	15.3	2.7	18.2	3.2	23.5	3.9	-	-
21	SX	14.7	3.3	19.5	4.3	24.5	5.4	29.2	6.5	35.3	7.8	-	-
22	SD	17.2	3.4	22.5	4.4	28.3	5.5	34.0	6.6	42.1	7.6	-	-
33	ST	24.9	5.1	-	-	41.7	8.2	50.1	9.8	69.6	11.5	94.7	16.6

n-Coefficients

Type	SS	Nominal Height (mm)					
		300	400	500	600	750	900
11	SS	1.2981	1.3026	1.3070	1.3115	1.3143	-
21	SX	1.2803	1.2940	1.3076	1.3213	1.3302	-
22	SD	1.3094	1.3182	1.3270	1.3358	1.3460	-
33	ST	1.3140	-	1.3428	1.3486	1.3515	1.3600

Connection options

4 x 1/2" BSP

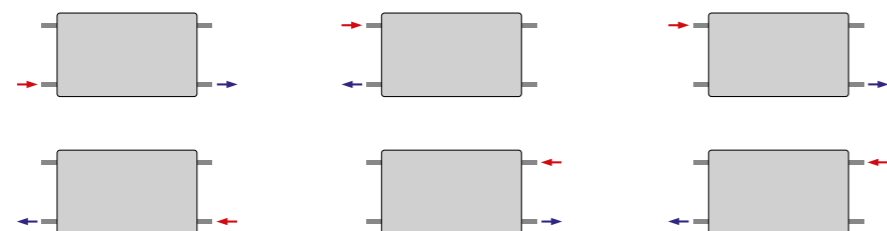

Mounting positions & dimensions

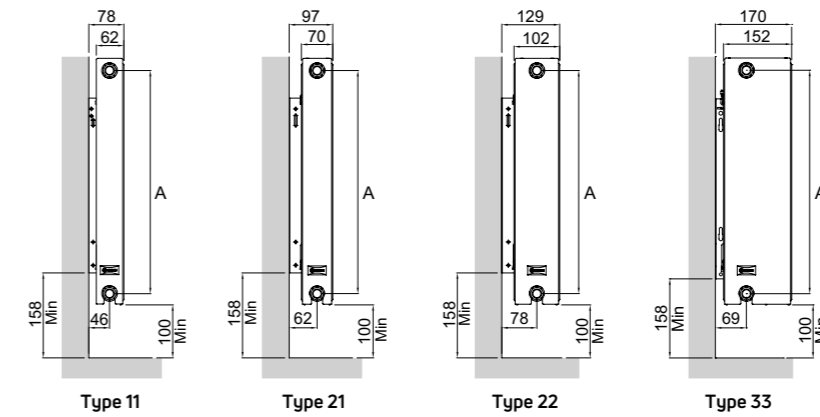

Nominal Height (mm)	A (mm)
300	250
400	350
500	450
600	550
750	700
900	850

Wall & floor brackets

Wall Brackets

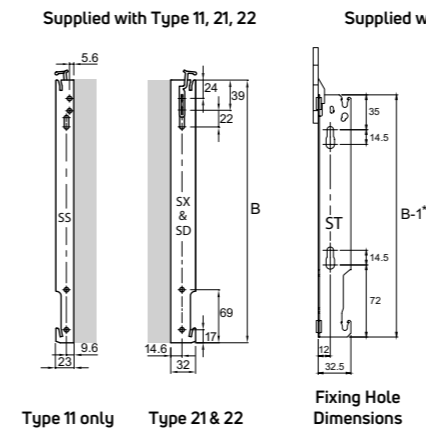

Nominal Height (mm)	B (mm)
300	142
400	242
500	342
600	442
750	591
900	742

*Use dimension B+9 for 300mm high Type 33

Floor Brackets

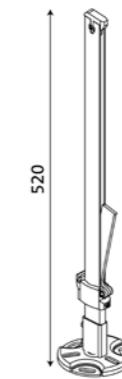

Floor brackets for all types:

- Radiator to wall distance: Any
- Maximum load of a single bracket:
Vertically - 180kg
Pulling - 35kg

Order Code: RH033 (single piece)

Height 300 - 750mm	
Radiator length (mm)	Quantity of floor brackets*
400 - 1600	2
1800 - 2300	3
2400 - 2600	4
2700 - 3000	5

*The floor brackets will support the radiators, however, in certain instances the brackets will flex and where possible the radiator should be fixed to the wall using the top bracket.

NB: All measurements are nominal.

Bracket positions & dimensions

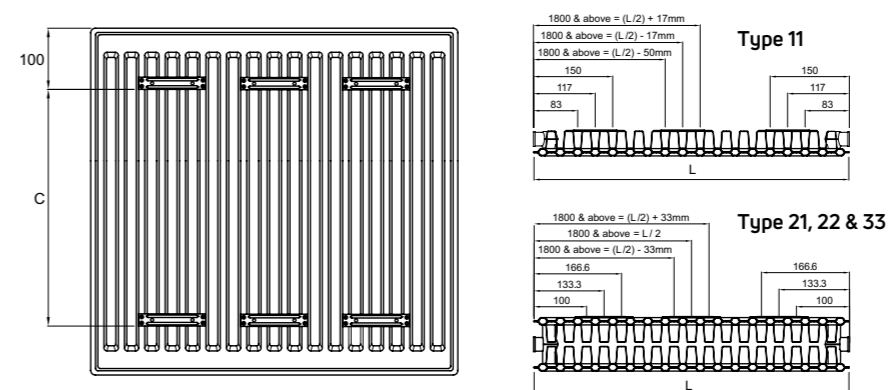

Nominal Height (mm)	C (mm)
300	120
400	220
500	320
600	420
750	570
900	720



NEW PROFILE with higher outputs!

The VERTICAL is the ultimate space saving solution, with a traditional front panel available in a choice of four types, two heights and four lengths. They come with six connections as standard which provides a variety of central or side pipe connection options.

A range of flat front vertical radiators are also available, see page 70.

- The VERTICAL is suitable for narrow and tall wall spaces
- The VERTICAL type 10 comes without side panels

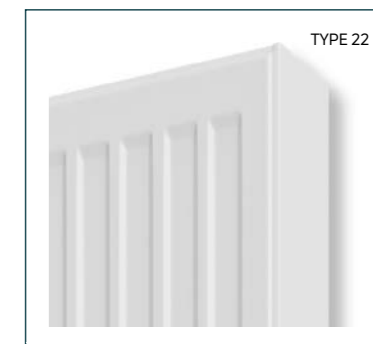

TYPE 21













TYPE 21 WITH TOWEL BAR

VERTICAL

VERTICAL

General specification & technical information

-  **CERTIFICATION**
Manufactured and tested to BS EN 442 & EN 442. Carries the CE & UKCA Mark. Produced under a quality management system - ISO 9001:2015, environmental management system - ISO 14001:2015 and Occupational health and safety management system - ISO 45001:2018.
-  **GUARANTEE**
10 year guarantee from date of purchase against manufacturing defects.
-  **COLOUR**
Finished in white (RAL 9016) as standard. Selected RAL, textured and metallic colours available to order. Please see page 266.
-  **ACCESSORIES**
Touch up paint is available to order.
-  **SYSTEM**
2 pipe pumped indirect domestic and commercial heating applications.
-  **CONNECTIONS**
6 x 1/2" BSP.
NB. Type 22 radiators have the connection valve located eccentrically in the radiator.

-  **AIR VENTS**
Air vent and plug packs are included in the packaging.
-  **OPERATING PRESSURES**
Tested to a pressure of 13 bar.
Working pressure of up to 10 bar.
-  **OPERATING TEMPERATURE**
Maximum 110°C.
-  **DELIVERY**
2 - 5 working days.
Non-stocked items: 2 - 3 weeks. Colours 4 - 6 weeks.
-  **VALVES**
Please see page 37.

For more general information, please see page 264.

Hydronic connection

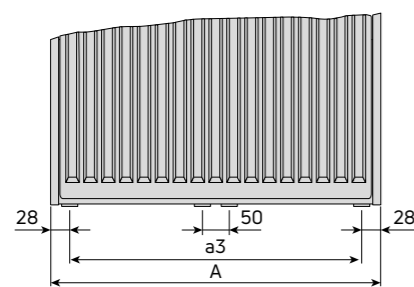

A	300	450	600	750
a3	244	394	544	694

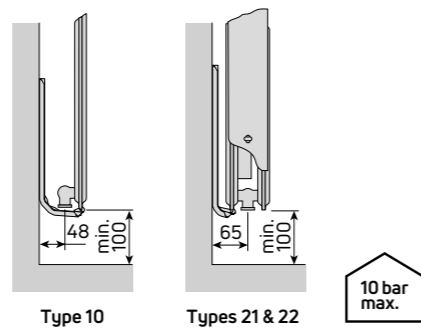
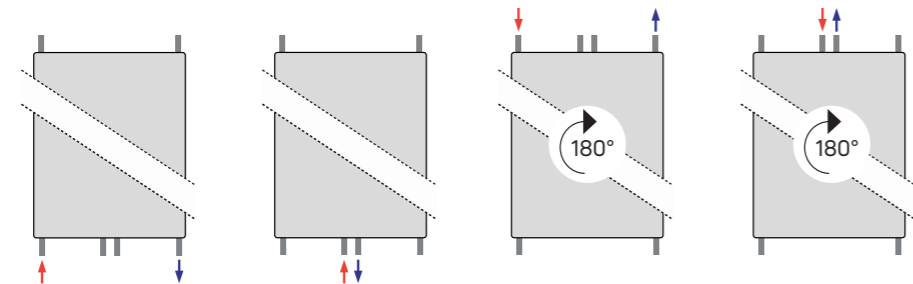

10 bar max.

Mounting positions & dimensions

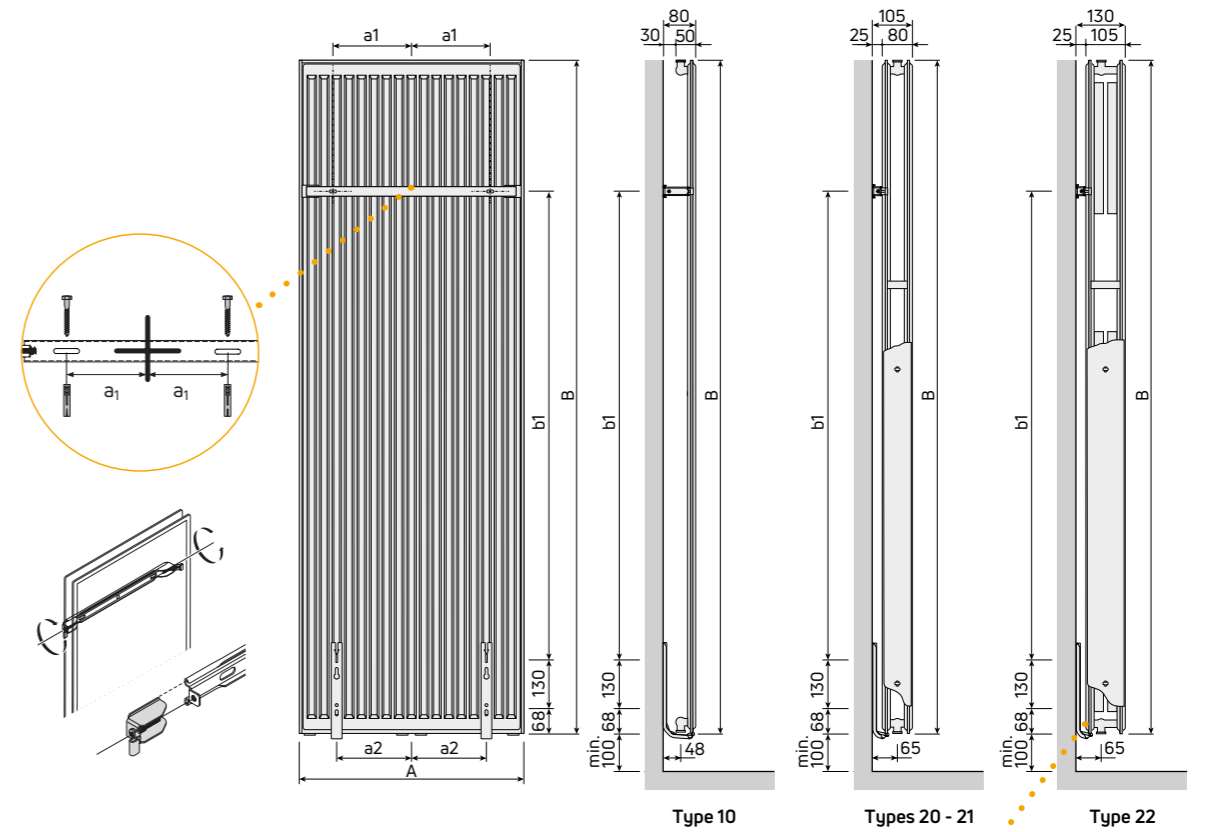

A	300	450	600	750
a1	60	135	210	285
a2	75	125	200	250

B	1800	1950
b1	1252	1402

A = width, B = height
All dimensions in mm.

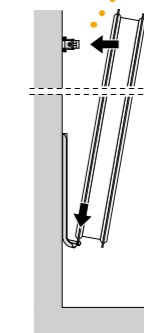

Brackets

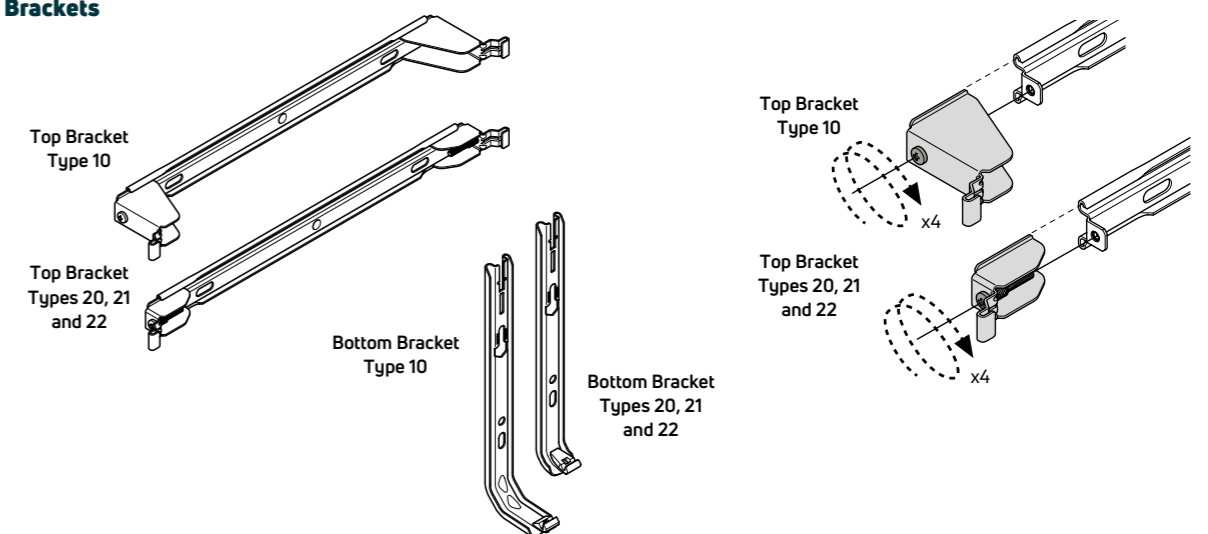

NB: ALL measurements are nominal.

VERTICAL

Heat outputs & technical information

TYPE 10



Nominal Height	Nominal Length (mm)	Heat Outputs @ ΔT 50°C		Heat Outputs @ ΔT 30°C		Weight (kg)	Water Content (l)	n-Coefficients	Order Code
		Watts	Btu/h	Watts	Btu/h				
1800mm	450	852	2907	443	1512	15.9	3.78	1.2787	VER180SP45
	600	1102	3760	571	1948	20.9	4.92	1.2877	VER180SP60
	750	1346	4593	694	2368	25.9	6.05	1.2966	VER180SP75 *
1950mm	450	919	3136	477	1628	17.19	4.12	1.2837	VER195SP45
	600	1189	4057	615	2098	22.63	5.38	1.2905	VER195SP60 *
	750	1452	4954	748	2552	28.08	6.65	1.2974	VER195SP75 *

TYPE 20



1800mm	300	904	3084	468	1597	24.15	4.8	1.2887	VER180DP30
	450	1303	4446	671	2289	33.93	7.23	1.2980	VER180DP45
	600	1689	5763	866	2955	43.72	9.67	1.3074	VER180DP60
	750	2065	7046	1054	3596	53.5	12.1	1.3167	VER180DP75 *
1950mm	300	968	3303	500	1706	26.08	4.8	1.2939	VER195DP30 *
	450	1395	4760	718	2450	36.73	7.8	1.3015	VER195DP45 *
	600	1807	6165	926	3160	47.38	10.4	1.3090	VER195DP60 *
	750	2210	7541	1128	3849	58.03	13	1.3166	VER195DP75 *

TYPE 21



1800mm	300	1036	3535	531	1812	25.75	4.8	1.3091	VER180DPX30 *
	450	1526	5207	779	2658	37.32	7.8	1.3157	VER180DPX45
	600	2009	6855	1022	3487	48.88	10.4	1.3222	VER180DPX60
	750	2486	8482	1261	4303	60.45	13	1.3288	VER180DPX75 *
1950mm	300	1108	3780	567	1935	27.75	5.2	1.3104	VER195DPX30 *
	450	1632	5568	832	2839	40.18	7.89	1.3182	VER195DPX45 *
	600	2148	7329	1091	3722	52.6	10.58	1.3261	VER195DPX60 *
	750	2658	9069	1345	4589	65.03	13.28	1.3340	VER195DPX75 *

TYPE 22



1800mm	300	1197	4084	613	2092	28.58	4.85	1.3099	VER180DC30
	450	1774	6053	905	3088	41.18	7.28	1.3166	VER180DC45
	600	2345	8001	1193	4071	53.78	9.72	1.3233	VER180DC60
	750	2912	9936	1476	5036	66.38	12.15	1.3300	VER180DC75
1950mm	300	1268	4326	649	2214	30.55	5.25	1.3098	VER195DC30 *
	450	1879	6411	960	3276	43.98	7.85	1.3149	VER195DC45
	600	2484	8475	1266	4320	57.42	10.45	1.3201	VER195DC60
	750	3084	10523	1567	5347	70.85	13.05	1.3252	VER195DC75

*Non-stock - made to order only.

Accessories

Product	Type	Finish	Order Code
VALVE SETS (Includes a nut & olive pack)			
	Angled	White	TVS-DAWH
		Chrome	TVS-DACH
		Matt Stainless Steel	TVS-DAMSS
	Straight	White	TVS-DSWH
		Chrome	TVS-DSCH
		Matt Stainless Steel	TVS-DSMSS
	Angled	White	TVS-AWH
		Chrome	TVS-ACH
		Matt Anthracite Grey	TVS-AMA
		Matt Jet Black	TVS-AMB
	Straight	White	TVS-SWH
		Chrome	TVS-SCH
		Matt Anthracite Grey	TVS-DSMA
		Matt Jet Black	TVS-DSMB
	Angled	White	TVS-VHXAWH
		Chrome	TVS-VHXACH
TOWEL BARS			
For Types 20, 21 & 22	300mm	White	VBARW300
	450mm	White	VBARW450
	600mm	White	VBARW600
	750mm	White	VBARW750

**Not to be used for top connection





The MYSON LST is the UK's most comprehensive and popular range of LST radiators, with both horizontal and vertical options available. The range is compliant with NHS Estates Guidance Notes 1998 and comes with anti-bacterial paint, making it ideal for hospital and care home applications. The LST range is also suitable for schools, student accommodation and other social housing projects as the surface temperature remains below 43°C and comes with safety conscious round steel casing, which eliminates sharp edges and ensures pipe work is concealed.

- The MYSON LST is available in 98 sizes
- It is available in three types, Super, Super Extra and Super Plus
- There are six different heights ranging from 572mm to 2072mm
- We offer selected models in length 420mm, which is the slimmest panel LST radiator on the market today, through to 2200mm, the widest panel LST radiator



LST RANGE















LST RANGE

(LOW SURFACE TEMPERATURE)

LST

General specification & technical information

-  **CERTIFICATION**
Manufactured and tested to BS EN 442 & EN 442. Carries the CE & UKCA Mark. Produced under a quality management system - ISO 9001:2015, environmental management system - ISO 14001:2015 and Occupational health and safety management system - ISO 45001:2018.
-  **GUARANTEE**
10 year guarantee from date of purchase against manufacturing defects for both the radiator and the casing.
-  **COLOUR**
All radiators are de-greased, phosphated and primer coated. An epoxy polyester finishing coat in white (RAL 9016) is applied to all front and rear surfaces.
-  **ANTI-BACTERIAL PAINT**
Coating to suppress bacterial growth.
-  **ACCESSORIES**
Touch up paint is available to order.
-  **SYSTEM**
2 pipe pumped indirect domestic and commercial heating applications.
-  **CONNECTIONS**
4 x 1/2" BSP. Please refer to control options on page 43.
-  **AIR VENTS**
Air vent and plug packs are included in the packaging.
-  **OPERATING PRESSURES**
Tested to a pressure of 10.5 bar. Working pressure of up to 8.0 bar.
-  **OPERATING TEMPERATURE**
Surface temperature below 43°C. Water inlet temperature up to 82°C.
-  **DELIVERY**
2 - 5 working days. Non-stocked items: 3 - 4 weeks.
-  **VALVES**
Please see page 43.
-  **BIM**
Visit our website to download the BIM components www.myson.co.uk/bim

For more general information, please see page 264.

Weights & water contents per radiator - LST SUPER

Nominal Length (mm)	Nominal Height (mm)							
	572		672		872		972**	
	Weight (kg)	Water Content (l)	Weight (kg)	Water Content (l)	Weight (kg)	Water Content (l)	Weight (kg)	Water Content (l)
420**	-	-	7.43	0.63	10.15	0.90	11.36	1.05
600	-	-	11.02	0.84	15.32	1.20	17.22	1.40
800	12.10	1.02	14.90	1.26	20.90	1.80	23.53	2.10
1000	15.22	1.36	18.80	1.68	26.50	2.40	29.88	2.80
1200	18.45	1.70	22.69	2.10	32.09	3.00	36.21	3.50
1400	21.63	2.04	26.62	2.52	37.73	3.60	42.57	4.20
1600	24.80	2.38	30.56	2.94	43.37	4.20	48.94	4.90
1800	27.94	2.72	34.53	3.36	49.04	4.80	55.34	5.60
2000	31.07	3.06	38.40	3.78	54.62	5.40	61.74	6.30
2200	-	-	42.27	4.20	60.20	6.00	-	-

Weights & water contents per radiator - LST SUPER EXTRA

Nominal Length (mm)	Nominal Height (mm)			
	672		872	
	Weight (kg)	Water Content (l)	Weight (kg)	Water Content (l)
600	14.63	1.72	20.39	2.48
800	19.96	2.58	28.51	3.72
1000	25.30	3.44	35.96	4.96
1200	30.84	4.30	43.88	6.20
1400	36.27	5.16	51.46	7.44
1600	41.74	6.02	60.07	8.68
1800	47.03	6.88	67.42	9.92
2000	53.19	7.74	75.03	11.16
2200	58.38	8.60	83.21	12.40

**Limited availability.

Weights & water contents per radiator - LST SUPER PLUS

Nominal Length (mm)	Nominal Height (mm)							
	572		672		872		972**	
	Weight (kg)	Water Content (l)	Weight (kg)	Water Content (l)	Weight (kg)	Water Content (l)	Weight (kg)	Water Content (l)
420**	-	-	10.61	1.29	14.78	1.86	16.62	2.10
600	-	-	16.28	1.72	23.04	2.48	26.07	2.80
800	17.92	2.04	22.36	2.58	31.88	3.72	36.18	4.20
1000	22.70	2.72	28.44	3.44	40.72	4.96	46.32	5.60
1200	27.50	3.40	34.52	4.30	49.59	6.20	56.45	7.00
1400	32.31	4.08	40.61	5.16	58.44	7.44	66.57	8.40
1600	37.12	4.76	46.74	6.02	67.33	8.68	76.73	9.80
1800	41.80	5.44	52.88	6.88	76.24	9.92	86.91	11.20
2000	46.74	6.12	58.94	7.74	85.06	11.16	97.09	12.60
2200	-	-	65.00	8.60	93.88	12.40	-	-

n-Coefficients

Type	Nominal Height (mm)	Nominal Height (mm)			
		572	672	872	972**
11	LS	1.3047	1.3027	1.3093	1.3178
21	LSX	-	1.2808	1.2640	-
22	LSP	1.3121	1.3229	1.3444	1.3528

Mounting positions & dimensions

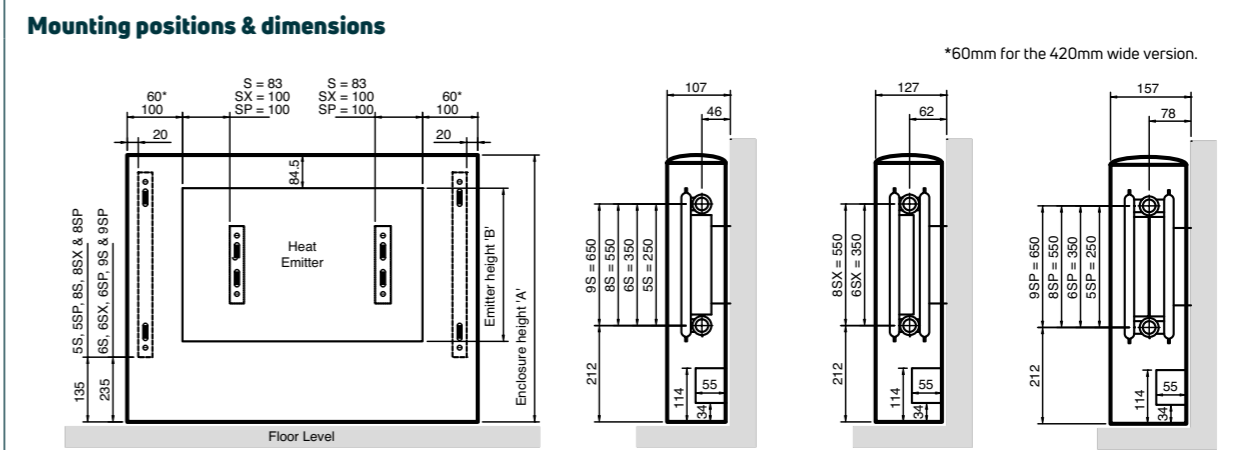

Enclosure Height A (mm)	Emitter Height B (mm)
572	300
672	400
872	600
972**	700

Important: It is advisable to leave a further 5mm clearance above any final floor covering to allow for easy fitting and removal.

NB: All measurements are nominal.

**Limited availability.

LST

Heat outputs

LST SUPER - Nominal Depth 107mm

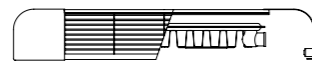

Nominal Height	Outer Casing Nominal Length (mm)	Heat Outputs @ ΔT 50°C		Heat Outputs @ ΔT 30°C		Order Code
		Watts	Btu/h	Watts	Btu/h	
572mm	800	277	946	139	475	5 LS 080
	1000	370	1261	186	634	5 LS 100
	1200	462	1576	232	792	5 LS 120
	1400	554	1890	278	949	5 LS 140
	1600	647	2207	325	1109	5 LS 160
	1800	739	2521	371	1266	5 LS 180
2000	832	2837	418	1426	5 LS 200	
672mm	420**	182	621	92	314	6 LS 042**
	600	243	830	123	418	6 LS 060
	800	365	1245	184	627	6 LS 080
	1000	486	1660	245	836	6 LS 100
	1200	608	2074	306	1045	6 LS 120
	1400	730	2489	368	1254	6 LS 140
	1600	851	2904	429	1463	6 LS 160
	1800	973	3319	490	1672	6 LS 180
2000	1094	3734	551	1881	6 LS 200	
2200	1216	4149	612	2088	6 LS 220*	
872mm	420**	265	904	134	457	8 LS 042**
	600	353	1205	179	610	8 LS 060
	800	530	1808	268	915	8 LS 080
	1000	706	2410	358	1221	8 LS 100
	1200	883	3013	447	1526	8 LS 120
	1400	1060	3615	537	1831	8 LS 140
	1600	1236	4218	626	2136	8 LS 160
	1800	1413	4820	716	2441	8 LS 180
2000	1589	5423	805	2746	8 LS 200	
2200	1766	6026	894	3050	8 LS 220*	
972mm**	420	304	1037	155	529	9 LS 042**
	600	405	1383	206	702	9 LS 060**
	800	608	2074	309	1053	9 LS 080**
	1000	810	2765	412	1404	9 LS 100**
	1200	1013	3456	514	1755	9 LS 120**
	1400	1216	4148	617	2106	9 LS 140**
	1600	1418	4839	720	2457	9 LS 160**
	1800	1621	5530	823	2808	9 LS 180**
2000	1823	6220	925	3156	9 LS 200**	

LST SUPER PLUS - Nominal Depth 157mm

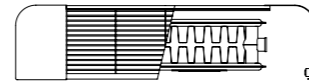

Nominal Height	Outer Casing Nominal Length (mm)	Heat Outputs @ ΔT 50°C		Heat Outputs @ ΔT 30°C		Order Code
		Watts	Btu/h	Watts	Btu/h	
572mm	800	545	1861	276	942	5 LSP 080
	1000	727	2481	368	1256	5 LSP 100
	1200	909	3102	460	1571	5 LSP 120
	1400	1091	3722	552	1883	5 LSP 140
	1600	1273	4342	644	2199	5 LSP 160
	1800	1454	4961	736	2511	5 LSP 180
2000	1636	5583	829	2827	5 LSP 200	
672mm	420**	351	1198	179	611	6 LSP 042**
	600	468	1597	238	811	6 LSP 060
	800	702	2395	357	1217	6 LSP 080
	1000	936	3194	475	1622	6 LSP 100
	1200	1170	3992	594	2028	6 LSP 120
	1400	1404	4790	713	2433	6 LSP 140
	1600	1638	5589	832	2839	6 LSP 160
	1800	1872	6387	951	3244	6 LSP 180
2000	2106	7186	1070	3650	6 LSP 200	
2200	2340	7984	1188	4053	6 LSP 220	
872mm	420**	494	1686	253	863	8 LSP 042**
	600	659	2249	337	1150	8 LSP 060
	800	989	3374	505	1724	8 LSP 080
	1000	1318	4498	674	2299	8 LSP 100
	1200	1648	5623	842	2874	8 LSP 120
	1400	1978	6748	1011	3449	8 LSP 140
	1600	2307	7872	1179	4023	8 LSP 160
	1800	2637	8997	1348	4598	8 LSP 180
2000	2966	10121	1516	5173	8 LSP 200	
2200	3296	11245	1684	5746	8 LSP 220	
972mm**	420	560	1911	287	979	9 LSP 042**
	600	747	2548	383	1306	9 LSP 060**
	800	1120	3822	574	1959	9 LSP 080**
	1000	1494	5096	766	2613	9 LSP 100**
	1200	1867	6370	957	3266	9 LSP 120**
	1400	2240	7644	1149	3919	9 LSP 140**
	1600	2614	8918	1340	4572	9 LSP 160**
	1800	2987	10192	1531	5225	9 LSP 180**
2000	3361	11468	1723	5879	9 LSP 200**	

LST SUPER EXTRA - Nominal Depth 127 mm



Nominal Height	Outer Casing Nominal Length (mm)	Heat Outputs @ ΔT 50°C		Heat Outputs @ ΔT 30°C		Order Code
		Watts	Btu/h	Watts	Btu/h	
672mm	600	355	1211	184	629	6 LSX 060
	800	532	1815	277	944	6 LSX 080
	1000	710	2423	369	1258	6 LSX 100
	1200	887	3026	461	1573	6 LSX 120
	1400	1064	3630	553	1888	6 LSX 140
	1600	1242	4238	645	2202	6 LSX 160
1800	1419	4842	738	2517	6 LSX 180	
2000	1597	5449	830	2831	6 LSX 200*	
2200	1774	6053	922	3146	6 LSX 220*	
872mm	600	483	1648	253	864	8 LSX 060
	800	725	2474	380	1296	8 LSX 080
	1000	966	3296	506	1728	8 LSX 100
	1200	1208	4122	633	2160	8 LSX 120
	1400	1450	4947	760	2592	8 LSX 140
	1600	1691	5770	886	3024	8 LSX 160
	1800	1933	6595	1013	3456	8 LSX 180*
	2000	2174	7418	1139	3888	8 LSX 200*
2200	2416	8243	1266	4320	8 LSX 220	

*Non-stock - made to order only.
**Limited availability.

LST

Valves & controls

MYSON offer a range of thermostatic valves designed to maximise the effectiveness of our range of Low Surface Temperature radiators. Three designs are available, the Universal Close Coupled and the Close Coupled Kit which

allows the case to be removed for cleaning without removing the TRV head, and the competitively priced Direct Fit Kit.

Direct fit TRV kit

Available for all LST's **except Vertical and 420mm wide**. Suitable for TBOE connection only. This kit allows a MYSON TRV to be mounted directly onto the internal radiator, making it an integral part of the LST radiator. This option utilises the 38mm knock out in the LST casing.

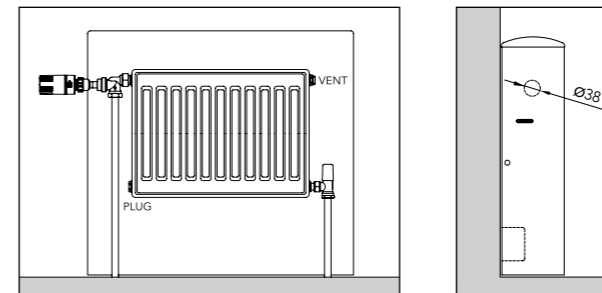

- Direct Fit TRV Kit comprises:**
- 1 x Horizontal angle TRV body
 - 1 x TRV head
 - 1 x Extension adaptor
 - 1 x Plastic bush
 - 1 x MATCHMASTER lockshield valve
- Order Code:** LSTDIRECTKITUK

Close coupled TRV kit

Available for all LST's **except Vertical and 420mm wide**. Suitable for TBOE, TBSE or BOE connections. This kit allows the MYSON TRV to be mounted directly onto the LST casing, with a choice of positions for both the TRV head and TRV angled valve body. This option utilises the 23mm knock out on the LST casing.

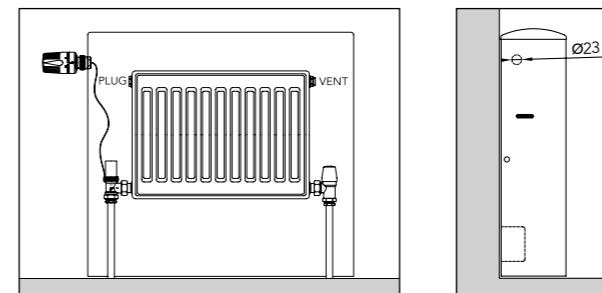

- Close Coupled TRV Kit comprises:**
- 1 x TRV head*
 - 1 x TRV angled body*
 - 1 x LST capillary unit/actuator/sensor head adaptor
 - 1 x MATCHMASTER angled lockshield valve
 - 1 x Locking tool
- Order Code:** LSTCCKITUK

Universal close coupled TRV kit

Available for all LST's. Suitable for TBOE, TBSE or BOE connections. This kit allows the MYSON TRV to be mounted directly onto the LST casing, with a choice of positions for both the TRV head and TRV straight valve body. This option utilises the 23mm knock out on the LST casing.

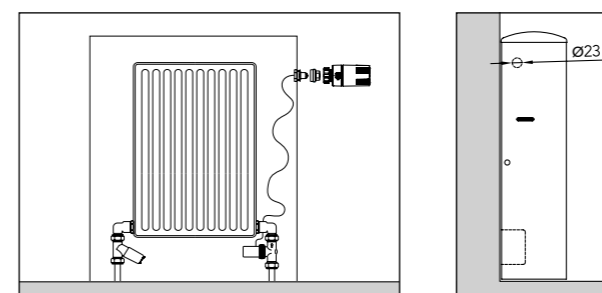

- Universal Close Coupled TRV Kit Comprises:**
- 1 x TRV head*
 - 1 x TRV straight body*
 - 1 x LST capillary unit/actuator/sensor head adaptor
 - 1 x MATCHMASTER straight lockshield valve
 - 2 x Integration elbows
- Order Code:** LSTUNIKITUK

Please see page 242 for more information.

*15mm compression copper only - for 1/2" iron pipe, an additional female adaptor is required.

LST VERTICAL

General specification & technical information

- CERTIFICATION**
Manufactured and tested to BS EN 442 & EN 442. Carries the CE & UKCA Mark. Produced under a quality management system - ISO 9001:2015, environmental management system - ISO 14001:2015 and Occupational health and safety management system - ISO 45001:2018.
- CONNECTIONS**
4 x 1/2" BSP. Please refer to control option on page 45.
- AIR VENTS**
Air vent and plug packs are included in the packaging.
- OPERATING PRESSURES**
Tested to a pressure of 8 bar.
Working pressure of up to 6.0 bar.
- OPERATING TEMPERATURE**
Surface temperature below 43°C.
Water inlet temperature up to 82°C.
- DELIVERY**
2 - 5 working days.
Non-stocked items: 3 - 4 weeks.
- VALVES**
Please see page 45.
- BIM**
Visit our website to download the BIM components www.myson.co.uk/bim
- GUARANTEE**
10 year guarantee from date of purchase against manufacturing defects for both the radiator and the casing.
- COLOUR**
All radiators are de-greased, phosphated and primer coated. An epoxy polyester finishing coat in white (RAL 9016) is applied to all front and rear surfaces.
- ANTI-BACTERIAL PAINT**
Coating to suppress bacterial growth.
- ACCESSORIES**
Touch up paint is available to order.
- SYSTEM**
2 pipe pumped indirect domestic and commercial heating applications.

For more general information, please see page 264.

Weights & water contents per radiator - LST VERTICAL

Nominal Length (mm)	Nominal Height (mm)			
	1772		2072	
	Weight (kg)	Water Content (l)	Weight (kg)	Water Content (l)
420	55.26	5.90	61.08	6.48
570	69.89	8.85	77.14	9.72
720	84.78	11.80	90.50	12.96
870	99.25	14.75	105.87	16.20

n-Coefficients

Type		Nominal Height (mm)	
		1772	2072
22	LSP	1.3581	1.3452

Heat outputs

LST VERTICAL - Nominal Depth 157mm



Nominal Height	Outer Casing Nominal Length (mm)	Heat Outputs @ ΔT 50°C		Heat Outputs @ ΔT 30°C		Order Code
		Watts	Btu/h	Watts	Btu/h	
1772mm	420	811	2768	405	1383	17 LSP 042
	570	1217	4152	608	2074	17 LSP 057
	720	1623	5537	811	2766	17 LSP 072
	870	2028	6921	1013	3457	17 LSP 087
2072mm	420	895	3054	450	1535	20 LSP 042*
	570	1342	4579	675	2303	20 LSP 057
	720	1789	6104	900	3071	20 LSP 072
	870	2237	7633	1125	3839	20 LSP 087

*Non-stock - made to order only.

Bracket positions & dimensions

Casing Width - A	420	570	720	870
Radiator Width - B	300	450	600	750
Centre Connections - C	50	50	50	50
Left-Right Connections - D	244	394	544	694

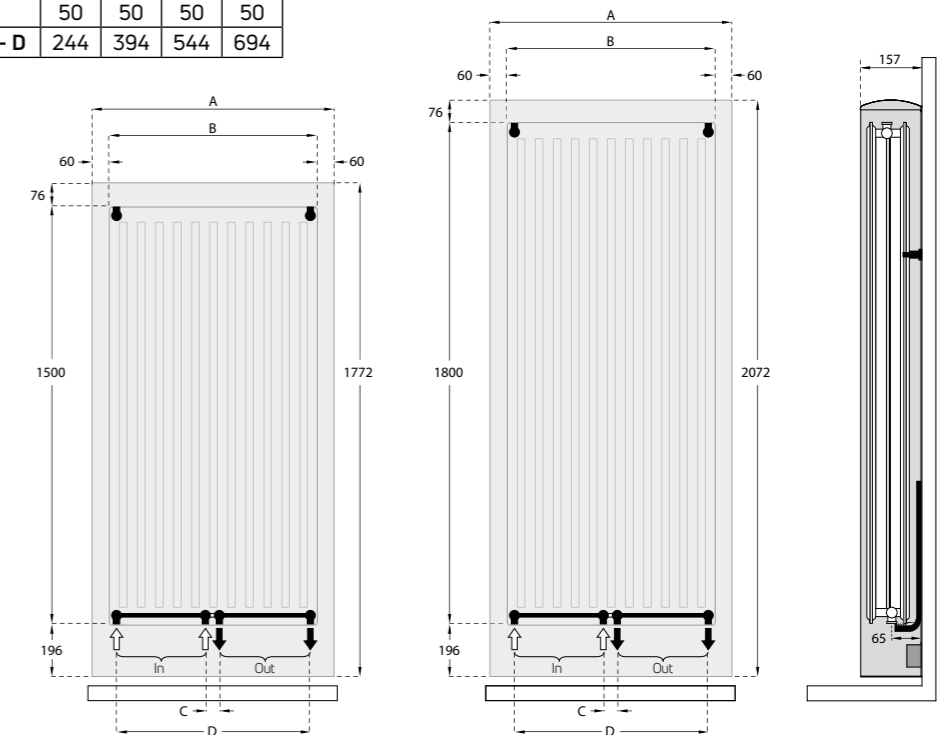

NB: All measurements are nominal.

Universal Close Coupled TRV Kit (supplied separate)

LST Vertical radiators can only be fitted with the Universal Close Coupled TRV Kit:

Note: Please discard the 2 integration elbows from the Close Coupled Kit and use the straight valve tails (supplied with the Vertical LST).

Please refer to the Universal Close Coupled TRV Kit instructions for more information.

The radiator has 6 connections. Please ensure you use the plug and vents (supplied with Vertical LST) in the unused connections.

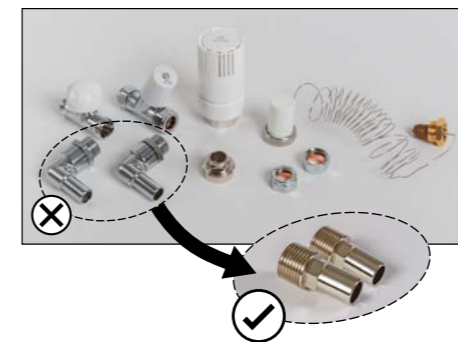

Universal Close Coupled TRV Kit comprises:

- 1 x TRV head**
- 1 x TRV straight body**
- 1 x LST capillary unit/actuator/sensor head adaptor
- 1 x MATCHMASTER straight lockshield valve
- 2 x Integration elbows

Order Code: LSTUNIKITUK

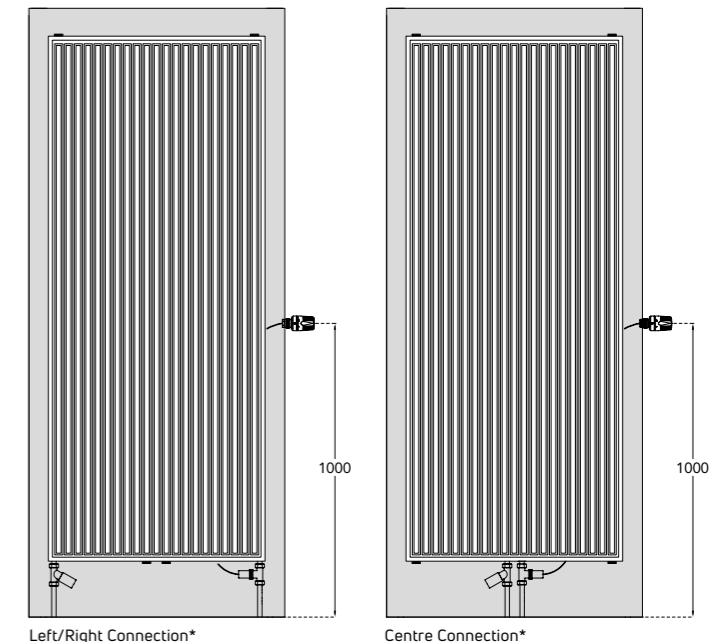

*Flow = left and Return = right for both connection options, please refer to the diagrams above.
**15mm compression copper only - for 1/2" iron pipe, an additional female adaptor is required.



Premium Panel radiators

The MYSON radiator range extends beyond the traditional steel panel radiator. Our Premium Panel range includes stylish contemporary radiators in the PLAN and PLAN PLUS ranges, and the T6 COMPACT and T6 PLAN which come with a pioneering central connection, allowing for easy installation. The ULOW-E2 brings an innovative heating approach, with fan assisted, intelligent low-temperature heating.

Our range of premium vertical radiators not only add timeless elegance to any room, they also provide a perfect solution for any horizontally challenged space. There are four models to choose from; KOS V, FARO V, PAROS V and TINOS V.



The PLAN range offers a contemporary alternative to the traditional panel radiator, combining good looks with leading performance.

The sleek flat front panel design of the PLAN offers a minimalist feel. Whilst maintaining all of the same benefits, the PLAN PLUS model takes this modern styling one step further with a decorative, rather than flat, front panel. Both models feature side panels and top grille.

Our flat front radiators are also available in a range of space-saving vertical models; KOS V, FARO V, TINOS V and PAROS V, see page 70.













- Available in 4 heights and 12 lengths, ranging from 400mm to 3000mm, the PLAN and PLAN PLUS offer a wide variety of sizes to suit any requirement
- Both models feature Type 11, Type 21 and Type 22 profiles, with the PLAN additionally available as a Type 33 profile



PLAN & PLAN PLUS

PLAN & PLAN PLUS

General specification & technical information

-  **CERTIFICATION**
Manufactured and tested to BS EN 442 & EN 442. Carries the CE & UKCA Mark. Produced under a quality management system - ISO 9001:2015, environmental management system - ISO 14001:2015 and Occupational health and safety management system - OHSAS 18001.
-  **GUARANTEE**
10 year guarantee from date of purchase against manufacturing defects.
-  **COLOUR**
All radiators are de-greased, phosphated and primer coated. An epoxy polyester finishing coat in white (RAL 9016) is applied to all front and rear surfaces.
-  **ACCESSORIES**
Touch up paint is available to order.
-  **SYSTEM**
2 pipe pumped indirect domestic and commercial heating applications.
-  **CONNECTIONS**
4 x 1/2" BSP. Please see below.
-  **AIR VENTS**
Air vent and plug packs are included in the packaging.
-  **OPERATING PRESSURES**
Tested to a pressure of 10.5 bar - 13 bar. Working pressure of up to 8 bar - 10 bar.
-  **OPERATING TEMPERATURE**
Maximum 100°C.
-  **DELIVERY**
2 - 5 working days. Non-stocked items: 4 - 5 weeks.
-  **VALVES**
Please see page 225.
-  **BIM**
Visit our website to download the BIM components www.myson.co.uk/bim

For more general information, please see page 264.

Weights & water contents per metre length

Type	Nominal Height (mm)							
	300		400		500		600	
	Weight (kg)	Water Content (l)	Weight (kg)	Water Content (l)	Weight (kg)	Water Content (l)	Weight (kg)	Water Content (l)
11	11.70	1.50	16.10	2.20	20.50	2.90	24.80	3.40
21	-	-	-	-	23.70*	5.20*	33.70	6.10
22	19.10	3.20	25.10	4.20	31.50	5.20	38.00	6.10
33*	26.90	5.10	36.70	6.30	42.20	7.50	56.40	8.80

*PLAN only.

n-Coefficients

Type	Nominal Height (mm)			
	300	400	500	600
11	1.2820	1.2824	1.2827	1.2831
21	-	-	1.2907*	1.2967
22	1.3000	1.3098	1.3197	1.3295
33*	1.3159	1.3245	1.3331	1.3417

*PLAN only.

Connection options

4 x 1/2" BSP

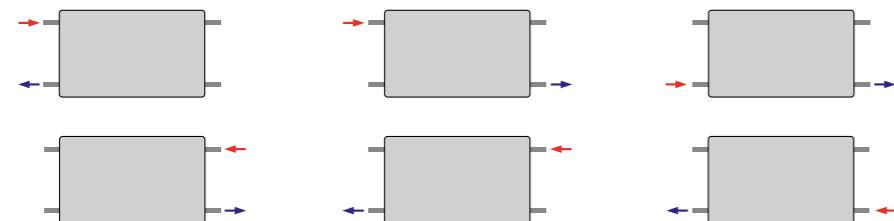

Mounting positions & dimensions

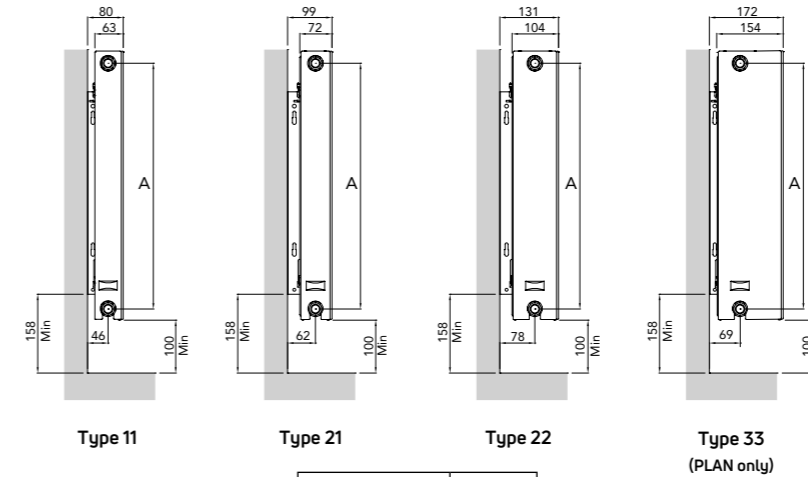

Nominal Height (mm)	A (mm)
300	250
400	350
500	450
600	550

Top View

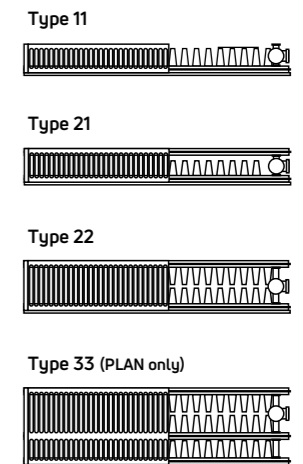

Bracket positions & dimensions

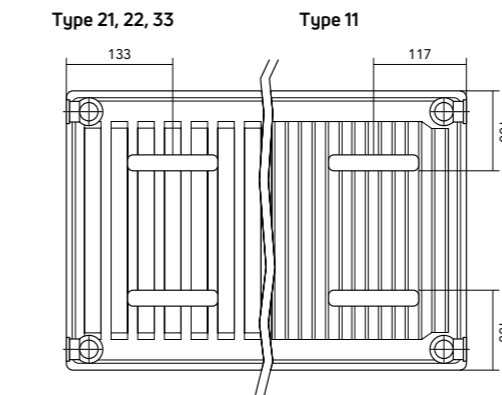

Bracket for use on - Type 11 and 33

Bracket for use on - Type 21 and 22

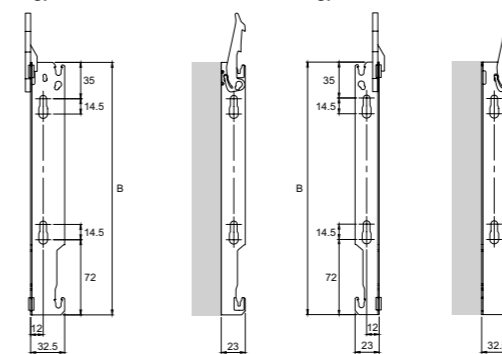

Nominal Height (mm)	B (mm)
300	151
400	241
500	341
600	441

Floor brackets

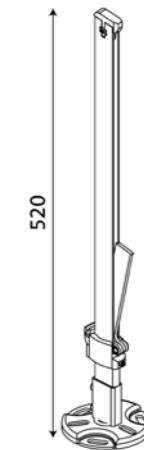

Floor brackets for all types:

Radiator to wall distance: Any
Maximum load of a single bracket:
Vertically - 180kg
Pulling - 35kg

Order Code: RH033 (single piece)

Height 300 - 700mm	
Radiator length (mm)	Quantity of floor brackets*
400 - 1600	2
1800 - 2300	3
2400 - 2600	4
2700 - 3000	5

*The floor brackets will support the radiators, however, in certain instances the brackets will flex and where possible the radiator should be fixed to the wall using the top bracket.

NB: ALL measurements are nominal.

T6 is the market-leading central connection radiator across Europe, with an extensive range of sizes and options.

T6 COMPACT and T6 PLAN comes with a pioneering central connection which allows for any size radiator to be installed once the pipe has been placed. The flexibility offered by central connection radiators has been utilised across Europe for over 25 years.

The T6 is the only radiator with a patented T distribution system, aiding an even heat up of the panel and providing the most effective water distribution.

- Patented T6 Technology
- 7 connection options available, see page 59
- T6 offers 106 COMPACT and 82 PLAN SKU's in the range
- Comes with pre-set valve, factory fitted for ease of installation
- Outputs range from 339W to 4454W



T6 COMPACT & T6 PLAN

PREMIUM PANEL RADIATORS

PREMIUM PANEL RADIATORS

T6 COMPACT & T6 PLAN

General overview

PREMIUM PANEL RADIATORS

PREMIUM PANEL RADIATORS



Pre-set valve
factory fitted and pre-installed for correct flow rates.
Can be reinstalled on the opposite side of the radiator if required.



Thermostatic sensor head
manufactured to work with the pre-set valve.
Sold separately. See page 57.
Note: not all TRV heads will fit.

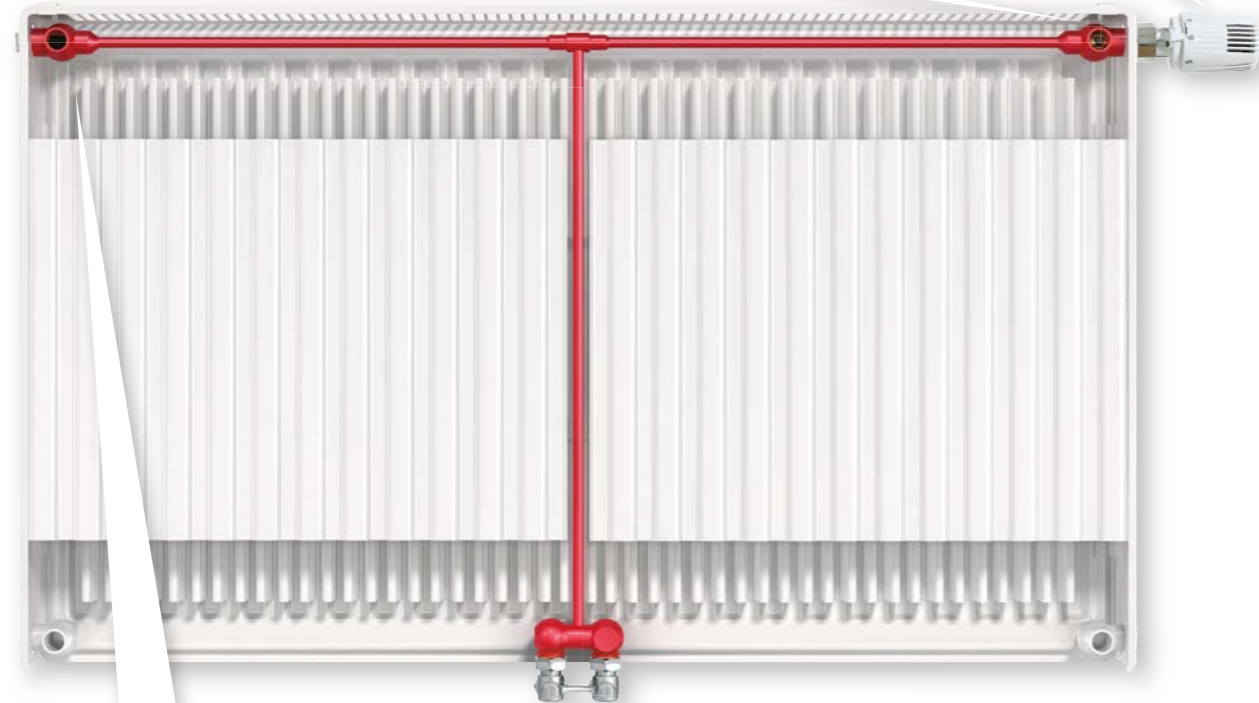

T6 vent plug used to vent the radiator.
Pre-fitted and like the pre-set valve, can be removed and reinstalled on the opposite side of the radiator if required.



Twin entry valve for central connection.
Available in straight or angled.
Sold separately. See page 57.

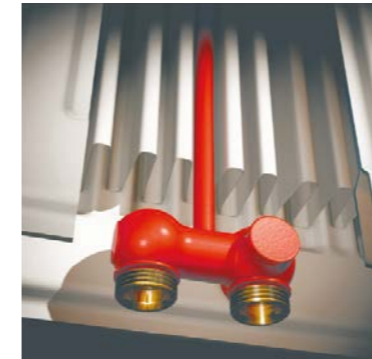

CENTRAL CONNECTION

- **Ultimate design/install flexibility:**
Central connection allows for any size radiator to be installed once pipes have been placed
- **Patented 'T' distribution system:**
T6 is the only radiator with this design, aiding even heat up of the panel
- T6 provides the most effective water distribution method

PRE-SET VALVE

- **Pre-balances the radiator to the correct flow rate:**
Based on the output of the radiator the correct valve is fitted at the factory
- Factory-fitted valve is removable and can be fitted to either side for added flexibility, if required
- Helps maintain a more constant room temperature due to improved radiant output from panel

Accessories













Product	Order Code
Twin Entry Valve (Straight)**	TEVS
Twin Entry Valve (Angled)**	TEVA
Twin Entry Reversible Flow Valve (Straight)**	TERFVS
Twin Entry Reversible Flow Valve (Angled)**	TERFVA
3/4" Chrome Caps - to blank off the twin-entry tappings	TEBLANKCAP
15mm Nut & Olive Pack (Copper)	NOP15*
Herz-TS Thermostatic Sensor Head (White)	HERZ



*Non-stock - made to order only.
**Nut & olive pack included.

T6 COMPACT & T6 PLAN

General specification & technical information

-  **CERTIFICATION**
Manufactured and tested to BS EN 442 & EN 442. Carries the CE & UKCA Mark. Produced under a quality management system - ISO 9001:2015, environmental management system - ISO 14001:2015 and Occupational health and safety management system - OHSAS 18001.
-  **GUARANTEE**
10 year guarantee from date of purchase against manufacturing defects.
-  **COLOUR**
Finished in white (RAL 9016).
-  **ACCESSORIES**
Central connection twin entry valve and Herz TRV are sold separately. Please see page 57.
-  **SYSTEM**
2 pipe pumped indirect domestic and commercial heating applications.
-  **CONNECTIONS**
4 x 1/2" BSP connections and 2 x 3/4" external thread, bottom center connections.
-  **AIR VENTS**
Air vent and plug packs are pre-installed.
-  **OPERATING PRESSURES**
Tested to a pressure of 13 bar. Working pressure of up to 10 bar.
-  **OPERATING TEMPERATURE**
Maximum 110°C.
-  **DELIVERY**
2 - 5 working days. Non-stocked items: 4 - 5 weeks.
-  **VALVES**
Please see page 57.
-  **BIM**
Visit our website to download the BIM components www.myson.co.uk/bim

For more general information, please see page 264.

T6 COMPACT weights & water contents per metre length

Type	Nominal Height (mm)							
	300		400		500		600	
	Weight (kg)	Water Content (l)	Weight (kg)	Water Content (l)	Weight (kg)	Water Content (l)	Weight (kg)	Water Content (l)
11	11.35	2.00	14.78	2.60	16.61	3.30	18.41	3.70
21	-	-	-	-	25.29	6.10	28.82	7.10
22	19.45	3.90	26.03	5.00	29.79	6.10	33.36	7.10

T6 PLAN weights & water contents per metre length

Type	Nominal Height (mm)							
	300		400		500		600	
	Weight (kg)	Water Content (l)	Weight (kg)	Water Content (l)	Weight (kg)	Water Content (l)	Weight (kg)	Water Content (l)
11	14.20	2.00	18.54	2.60	21.29	3.30	24.00	3.70
21	-	-	-	-	30.27	6.10	34.41	7.10
22	22.30	3.90	29.79	5.00	34.47	6.10	38.95	7.10

T6 COMPACT & T6 PLAN n-Coefficients

Type	Nominal Height (mm)							
	300		400		500		600	
	T6 COMPACT	T6 PLAN	T6 COMPACT	T6 PLAN	T6 COMPACT	T6 PLAN	T6 COMPACT	T6 PLAN
11	1.330	1.311	1.342	1.321	1.330	1.313	1.319	1.303
21	-	-	-	-	1.323	1.299	1.310	1.302
22	1.307	1.304	1.353	1.328	1.334	1.322	1.343	1.337

Connection options

Centre connection 2 x 3/4"

For optimum performance

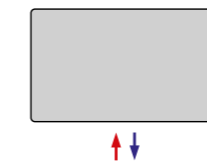

*Flow specific.

External thread 4 x 1/2" BSP

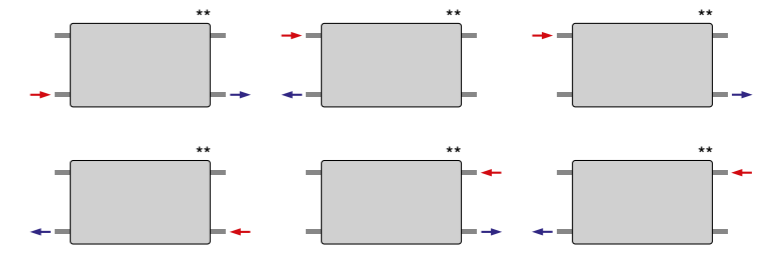

**When installing the T6 COMPACT & T6 PLAN radiators using the standard 4 x 1/2" BSP connections, the 3/4" bottom centre connections must be capped off using chrome caps (order code: TEBLANKCAP).

NOTE: If using any of the above connections, the pre-set valve and baffle on the vent plug need to be removed and capped where necessary.

Mounting positions, dimensions & wall brackets

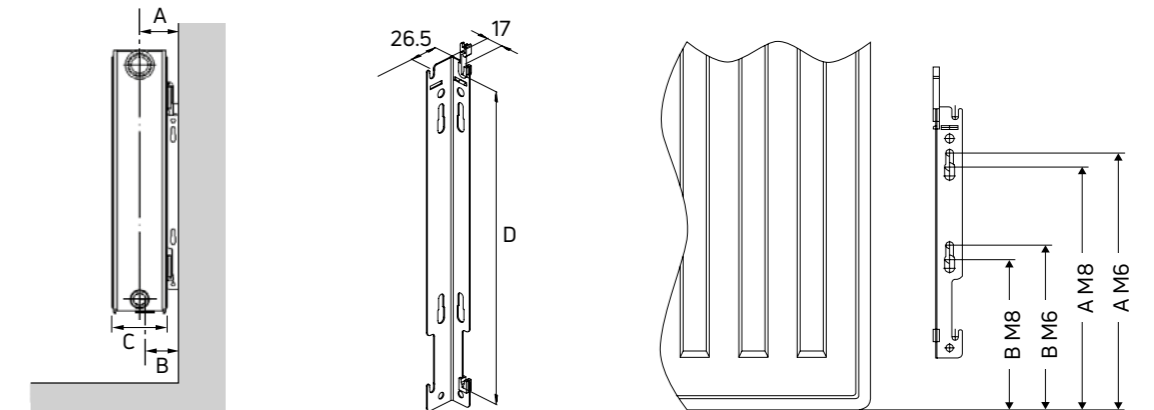

Type	A (mm)	B (mm)	C (mm)
11	50	50	61
21	74	66	80
22	86	66	105

Height (mm)	D (mm)
300	123
400	223
500	323
600	423

Height (mm)	M8		M6	
	A (mm)	B (mm)	A (mm)	B (mm)
300	138	-	152.5	-
400	238	143	252.5	157.5
500	338	143	352.5	157.5
600	438	143	452.5	157.5

A = Wall to side connection.
B = Wall to centre bottom connection.

NB: All measurements are nominal.

Bracket positions & dimensions

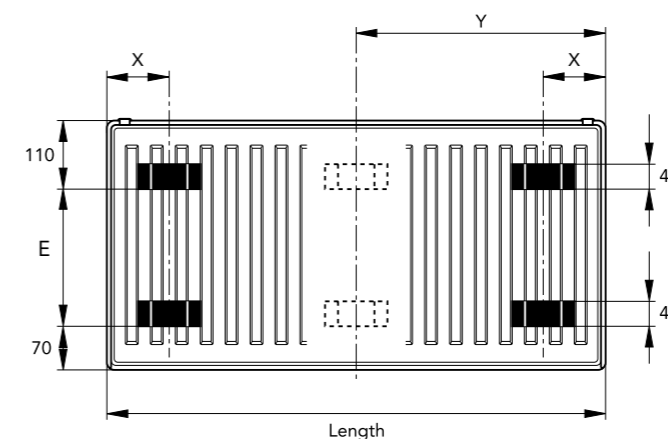

Type	X (mm)	Nominal Height (mm)	E (mm)
11	93	300	120
21	100	400	220
22	100	500	320
		600	420

$$\text{Dimension Y} = \frac{\text{Overall Length}}{2}$$

For all radiators with an overall length of 1800mm and above.

T6 COMPACT

Heat outputs

Type 11



Nominal Height	Nominal Length (mm)
300mm	600
	1000
	1400
	2000
400mm	400
	600
	800
	1000
	1200
	1400
	1600
	1800
500mm	400
	520
	600
	720
	800
	920
	1000
	1200
	1400
	1600
600mm	400
	520
	600
	720
	800
	920
	1000
	1120
	1200
	1320
	1400
	1600
	1800
	2000
2600	

Heat Outputs @ ΔT 50°C		Heat Outputs @ ΔT 30°C		Order Code
Watts	Btu/h	Watts	Btu/h	
339	1157	172	587	T6C 30 SC 60*
565	1928	286	977	T6C 30 SC 100
791	2699	401	1368	T6C 30 SC 140*
1130	3856	573	1955	T6C 30 SC 200
283	966	143	487	T6C 40 SC 40
425	1450	214	731	T6C 40 SC 60*
566	1931	285	973	T6C 40 SC 80*
708	2416	357	1217	T6C 40 SC 100*
850	2900	428	1461	T6C 40 SC 120*
991	3381	499	1703	T6C 40 SC 140*
1133	3866	571	1948	T6C 40 SC 160
1274	4347	642	2190	T6C 40 SC 180
1416	4831	713	2434	T6C 40 SC 200*
337	1150	171	583	T6C 50 SC 40*
438	1494	222	757	T6C 50 SC 52
506	1726	257	875	T6C 50 SC 60*
607	2071	308	1050	T6C 50 SC 72*
674	2300	342	1166	T6C 50 SC 80*
776	2648	393	1342	T6C 50 SC 92*
843	2876	427	1458	T6C 50 SC 100*
1012	3453	513	1750	T6C 50 SC 120*
1180	4026	598	2041	T6C 50 SC 140*
1349	4603	684	2333	T6C 50 SC 160
1517	5176	769	2624	T6C 50 SC 180
1686	5753	855	2916	T6C 50 SC 200
376	1283	192	654	T6C 60 SC 40
488	1665	249	849	T6C 60 SC 52
563	1921	287	979	T6C 60 SC 60
676	2307	345	1176	T6C 60 SC 72*
751	2562	383	1306	T6C 60 SC 80
864	2948	440	1503	T6C 60 SC 92*
939	3204	479	1633	T6C 60 SC 100*
1052	3589	536	1830	T6C 60 SC 112*
1127	3845	575	1960	T6C 60 SC 120*
1239	4227	632	2155	T6C 60 SC 132
1315	4487	670	2287	T6C 60 SC 140*
1502	5125	766	2613	T6C 60 SC 160
1690	5766	862	2939	T6C 60 SC 180
1878	6408	957	3267	T6C 60 SC 200
2441	8329	1244	4246	T6C 60 SC 260

Type 21

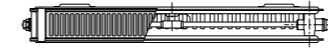

Heat Outputs @ ΔT 50°C		Heat Outputs @ ΔT 30°C		Order Code
Watts	Btu/h	Watts	Btu/h	
491	1675	250	852	T6C 50 DPX 40*
638	2177	325	1108	T6C 50 DPX 52*
736	2511	374	1277	T6C 50 DPX 60*
883	3013	449	1533	T6C 50 DPX 72*
982	3351	500	1705	T6C 50 DPX 80*
1129	3852	574	1960	T6C 50 DPX 92*
1227	4187	624	2130	T6C 50 DPX 100*
1472	5022	749	2555	T6C 50 DPX 120*
1718	5862	874	2982	T6C 50 DPX 140
1963	6698	999	3408	T6C 50 DPX 160
2209	7537	1124	3834	T6C 50 DPX 180*
2454	8373	1248	4260	T6C 50 DPX 200
543	1853	278	949	T6C 60 DPX 40
706	2409	362	1234	T6C 60 DPX 52*
814	2777	417	1422	T6C 60 DPX 60
977	3334	500	1707	T6C 60 DPX 72
1086	3705	556	1897	T6C 60 DPX 80*
1248	4258	639	2181	T6C 60 DPX 92*
1357	4630	695	2371	T6C 60 DPX 100*
1520	5186	778	2656	T6C 60 DPX 112*
1628	5555	834	2845	T6C 60 DPX 120*
1791	6111	917	3130	T6C 60 DPX 132*
1900	6483	973	3320	T6C 60 DPX 140
2171	7407	1112	3793	T6C 60 DPX 160*
2443	8336	1251	4269	T6C 60 DPX 180
2714	9260	1390	4742	T6C 60 DPX 200

Type 22



Heat Outputs @ ΔT 50°C		Heat Outputs @ ΔT 30°C		Order Code
Watts	Btu/h	Watts	Btu/h	
616	2102	316	1078	T6C 30 DC 60*
1026	3501	526	1796	T6C 30 DC 100*
1436	4900	737	2513	T6C 30 DC 140*
2052	7001	1052	3591	T6C 30 DC 200*
543	1853	272	928	T6C 40 DC 40*
814	2777	408	1391	T6C 40 DC 60*
1086	3705	544	1856	T6C 40 DC 80*
1357	4630	680	2320	T6C 40 DC 100*
1628	5555	816	2783	T6C 40 DC 120*
1900	6483	952	3248	T6C 40 DC 140*
2171	7407	1088	3711	T6C 40 DC 160*
2443	8336	1224	4176	T6C 40 DC 180*
2714	9260	1360	4639	T6C 40 DC 200
617	2105	312	1065	T6C 50 DC 40
802	2736	406	1384	T6C 50 DC 52
926	3160	468	1599	T6C 50 DC 60
1111	3791	562	1918	T6C 50 DC 72
1234	4210	624	2130	T6C 50 DC 80
1420	4845	718	2451	T6C 50 DC 92
1543	5265	781	2663	T6C 50 DC 100
1852	6319	937	3197	T6C 50 DC 120
2160	7370	1093	3728	T6C 50 DC 140*
2469	8424	1249	4262	T6C 50 DC 160*
2777	9475	1405	4793	T6C 50 DC 180*
3086	10529	1561	5326	T6C 50 DC 200
685	2337	345	1177	T6C 60 DC 40
891	3040	449	1531	T6C 60 DC 52
1028	3508	518	1767	T6C 60 DC 60
1233	4207	621	2119	T6C 60 DC 72
1370	4674	690	2354	T6C 60 DC 80
1576	5377	794	2708	T6C 60 DC 92*
1713	5845	863	2943	T6C 60 DC 100
1919	6548	966	3297	T6C 60 DC 112*
2056	7015	1035	3533	T6C 60 DC 120
2261	7715	1139	3885	T6C 60 DC 132*
2398	8182	1208	4120	T6C 60 DC 140*
2741	9352	1380	4709	T6C 60 DC 160*
3083	10519	1552	5297	T6C 60 DC 180*
3426	11690	1725	5887	T6C 60 DC 200
4454	15197	2243	7653	T6C 60 DC 260

*Non-stock - made to order only.

HOW TO ORDER YOUR T6 COMPACT



1

Choose your T6 COMPACT



Includes brackets

2

Choose your twin entry valve:
Straight (TEVS)
Angled (TEVA)

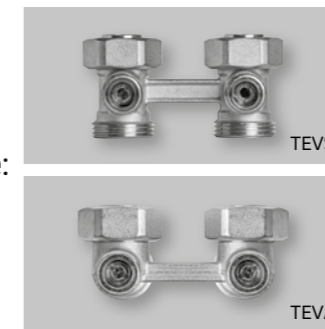

Includes a nut & olive pack

3

Don't forget your TRV head:
Herz TRV (HERZ)



T6 PLAN

Heat outputs

Type 11



Nominal Height	Nominal Length (mm)
300mm	600
	1000
	1400
	2000
400mm	400
	600
	800
	1000
	1200
	1400
	1600
	1800
500mm	400
	600
	800
	1000
	1200
	1400
	1600
600mm	400
	600
	800
	1000
	1200
	1400
	1600
	1800
2000	
2600	

Heat Outputs @ ΔT 50°C		Heat Outputs @ ΔT 30°C		Order Code
Watts	Btu/h	Watts	Btu/h	
319	1088	163	557	T6P 30 SC 60
532	1815	272	929	T6P 30 SC 100
745	2542	381	1301	T6P 30 SC 140
1064	3630	545	1858	T6P 30 SC 200
264	901	134	459	T6P 40 SC 40
396	1351	202	688	T6P 40 SC 60
528	1802	269	918	T6P 40 SC 80
660	2252	336	1147	T6P 40 SC 100
792	2702	403	1376	T6P 40 SC 120
924	3153	471	1606	T6P 40 SC 140
1056	3603	538	1835	T6P 40 SC 160
1188	4053	605	2064	T6P 40 SC 180
1320	4504	672	2294	T6P 40 SC 200
314	1071	161	548	T6P 50 SC 40*
470	1604	240	820	T6P 50 SC 60
627	2139	321	1094	T6P 50 SC 80
784	2675	401	1368	T6P 50 SC 100
941	3211	481	1642	T6P 50 SC 120
1098	3746	561	1915	T6P 50 SC 140
1254	4279	641	2188	T6P 50 SC 160
1411	4814	722	2462	T6P 50 SC 180
1568	5350	802	2736	T6P 50 SC 200
338	1153	174	593	T6P 60 SC 40*
506	1726	260	887	T6P 60 SC 60*
675	2303	347	1184	T6P 60 SC 80*
844	2880	434	1480	T6P 60 SC 100*
1013	3456	521	1776	T6P 60 SC 120*
1182	4033	608	2073	T6P 60 SC 140*
1350	4606	694	2367	T6P 60 SC 160
1519	5183	781	2664	T6P 60 SC 180
1688	5759	868	2960	T6P 60 SC 200*
2194	7486	1128	3848	T6P 60 SC 260

Type 21

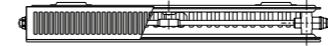

Heat Outputs @ ΔT 50°C		Heat Outputs @ ΔT 30°C		Order Code
Watts	Btu/h	Watts	Btu/h	
469	1600	242	824	T6P 50 DPX 40
704	2402	363	1237	T6P 50 DPX 60
938	3200	483	1648	T6P 50 DPX 80*
1173	4002	604	2061	T6P 50 DPX 100*
1408	4804	725	2474	T6P 50 DPX 120*
1642	5603	846	2886	T6P 50 DPX 140
1877	6404	967	3298	T6P 50 DPX 160
2111	7203	1087	3710	T6P 50 DPX 180
2346	8005	1208	4123	T6P 50 DPX 200
520	1774	267	912	T6P 60 DPX 40
781	2665	402	1370	T6P 60 DPX 60*
1041	3552	535	1827	T6P 60 DPX 80*
1301	4439	669	2283	T6P 60 DPX 100*
1561	5326	803	2739	T6P 60 DPX 120*
1821	6213	936	3195	T6P 60 DPX 140
2082	7104	1071	3653	T6P 60 DPX 160*
2342	7991	1204	4109	T6P 60 DPX 180*
2602	8878	1338	4565	T6P 60 DPX 200

Type 22



Heat Outputs @ ΔT 50°C		Heat Outputs @ ΔT 30°C		Order Code
Watts	Btu/h	Watts	Btu/h	
590	2013	303	1034	T6P 30 DC 60
984	3357	505	1724	T6P 30 DC 100*
1378	4702	708	2415	T6P 30 DC 140*
1968	6715	1011	3449	T6P 30 DC 200*
534	1822	271	925	T6P 40 DC 40
802	2736	407	1388	T6P 40 DC 60
1069	3647	542	1851	T6P 40 DC 80
1336	4558	678	2313	T6P 40 DC 100*
1603	5469	813	2775	T6P 40 DC 120
1870	6380	949	3237	T6P 40 DC 140
2138	7295	1085	3702	T6P 40 DC 160
2405	8206	1220	4164	T6P 40 DC 180*
2672	9117	1356	4626	T6P 40 DC 200
608	2074	309	1056	T6P 50 DC 40*
912	3112	464	1584	T6P 50 DC 60*
1216	4149	619	2112	T6P 50 DC 80*
1520	5186	774	2640	T6P 50 DC 100*
1824	6223	928	3167	T6P 50 DC 120*
2128	7261	1083	3696	T6P 50 DC 140*
2432	8298	1238	4224	T6P 50 DC 160*
2736	9335	1393	4751	T6P 50 DC 180*
3040	10372	1547	5279	T6P 50 DC 200
668	2279	337	1151	T6P 60 DC 40*
1001	3415	506	1725	T6P 60 DC 60*
1335	4555	674	2301	T6P 60 DC 80*
1669	5695	843	2877	T6P 60 DC 100*
2003	6834	1012	3452	T6P 60 DC 120*
2337	7974	1180	4028	T6P 60 DC 140*
2670	9110	1349	4602	T6P 60 DC 160*
3004	10250	1517	5177	T6P 60 DC 180*
3338	11389	1686	5753	T6P 60 DC 200*
4339	14805	2192	7478	T6P 60 DC 260*

*Non-stock - made to order only.

HOW TO ORDER YOUR T6 PLAN



1

Choose your T6 PLAN



Includes brackets

2

Choose your twin entry valve:
Straight (TEVS)
Angled (TEVA)

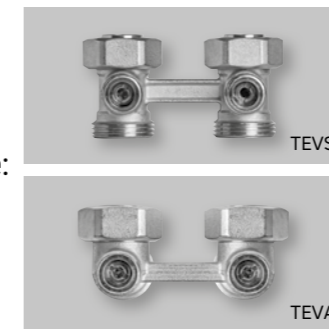

Includes a nut & olive pack

3

Don't forget your TRV head:
Herz TRV (HERZ)



HERZ



The ULOW-E2 is the ultimate choice when it comes to intelligent, low temperature heating. It uses in-built fans to force convection and produces heat outputs up to 60% more than traditional radiators. It has intelligent controls allowing the fans to work on a sliding scale where the water temperature must be 3°C higher than the set point. It is highly flexible, utilising central connection technology and has a "summer breeze" function for air circulation on warm days.

- The MYSON ULOW-E2 is available in nine sizes
- It is available in one type, double panel with factory fitted top grille and side panels as standard
- It comes in a height of 600mm
- We offer lengths from 400mm to 2000mm
- All our ULOW-E2 radiators come with a white electronic thermostatic actuator
- Central connection twin entry valve and nut & olive pack supplied separately



ULOW-E2



ULOW-E2



PLEASE NOTE: A twin entry valve and nut & olive pack are required for the central connection. These must be purchased separately.

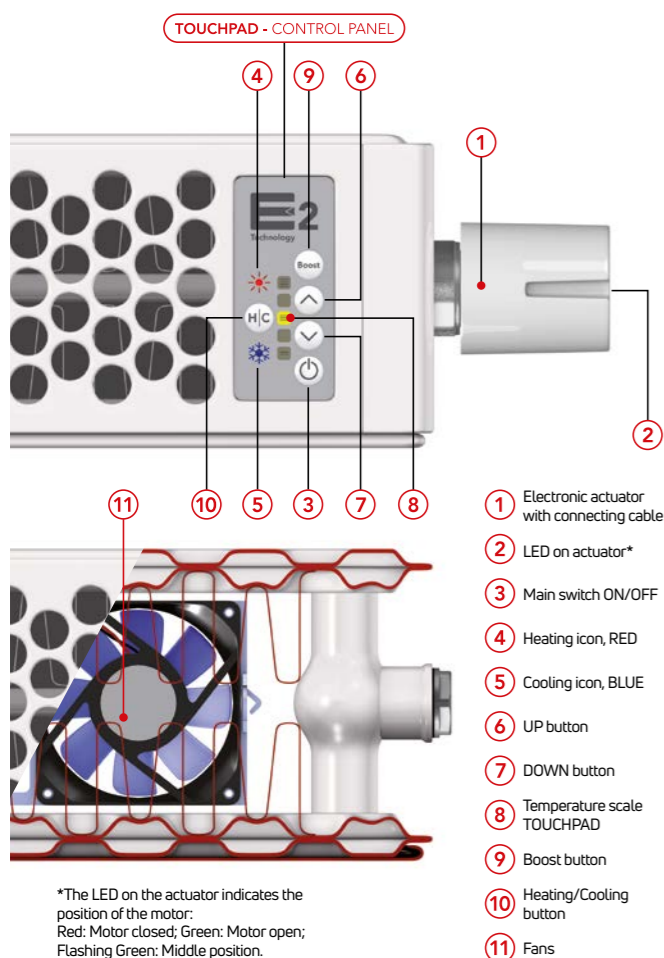

Low temperature compatible

The ULOW-E2 provides enhanced convection via in-built fans. This enables heat sources to operate at their most energy efficient settings. The result is a heating concept that can provide high heat outputs even at lower water temperatures.

Rapid response heating

Due to its combination of both radiant heat and enhanced convection, plus intelligent controls that automatically switch between static and dynamic operation, the ULOW-E2 provides a rapid heat response even at low water temperatures. Indoor comfort is quickly and efficiently achieved.

Intelligent controls

The E2 technology automatically and intelligently controls operation of the in-built fans to ensure maximum performance. The intelligence behind the ULOW-E2 means that the fans will only operate when they are required.



Central connection technology

The central connection system is easy to install and provides significant benefits. This extremely clever idea gives complete planning and installation freedom. Once in operation it will help the room feel warmer, faster by distributing hot water from the top of the ULOW-E2 downwards.

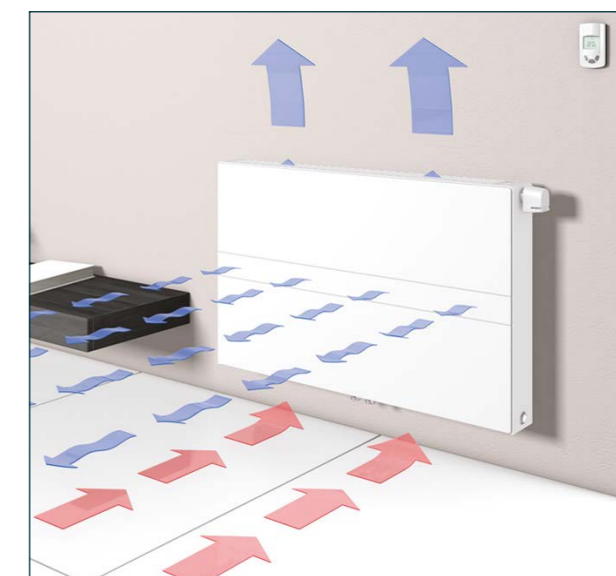













Summer breeze effect

During the summer months the fans from the ULOW-E2 provide gentle air movement to create a pleasant 'summer breeze' effect.

ULOW-E2

General specification & technical information

-  **CERTIFICATION**
Manufactured and tested to BS EN 442 & EN 442. Carries the CE & UKCA Mark. Produced under a quality management system - ISO 9001:2015, environmental management system - ISO 14001:2015 and Occupational health and safety management system - OHSAS 18001. Conforms to the Low Voltage Directive 2014/35/EU and the EMC Directive 2014/30/EU. Sound levels are tested to VDI 2081.
-  **GUARANTEE**
2 year guarantee from date of purchase against manufacturing defects.
-  **COLOUR**
Primer coated and finished in white (RAL 9016).
-  **ACCESSORIES**
Central connection twin entry valve and nut & olive pack are sold separately.
-  **SYSTEM**
2 pipe pumped indirect domestic and commercial heating applications.
-  **CONNECTIONS**
4 x G ½" internal thread and 2 x G ¾" external thread, underside centre. Thermostat valve top right (can be swapped to top left).
-  **AIR VENTS**
Air vent and plug packs are pre-installed.
-  **OPERATING PRESSURES**
Tested to a pressure of 10 bar. Working pressure of up to 13 bar.
-  **OPERATING TEMPERATURE**
Maximum 60°C (due to electrical components).
-  **ELECTRICAL SUPPLY**
220-240V-50Hz.
-  **IP RATING**
IP24.
-  **DELIVERY**
2 - 5 working days.
-  **VALVES**
Supplied with a white electronic thermostatic actuator as standard.

For more general information, please see page 264.

Weights & water contents per metre length, sound levels, motor power & n-coefficients

Model	Nominal Height (mm)	Nominal Length (mm)	Weight (kg)	Water Content (l)	No. of Fans	Sound Pressure (dBA) (at 2m)		Power (W)	n-Coefficients		
						Comfort	Boost		Boost	Static	Comfort
E2 60 DC 40	600	400	17.13	2.84	2	20.3	30.7	3.5	1.317	1.129	1.112
E2 60 DC 60	600	600	24.59	4.26	4	22.9	32.6	4.9	1.317	1.129	1.112
E2 60 DC 80	600	800	32.06	5.68	6	24.4	33.7	6.4	1.317	1.129	1.112
E2 60 DC 100	600	1000	39.70	7.10	8	25.4	34.4	7.8	1.317	1.129	1.112
E2 60 DC 120	600	1200	47.16	8.52	10	26.3	35.1	9.3	1.317	1.129	1.112
E2 60 DC 140	600	1400	53.02	9.94	12	26.9	35.6	10.8	1.317	1.129	1.112
E2 60 DC 160	600	1600	62.27	11.36	14	27.5	36.0	12.1	1.317	1.129	1.112
E2 60 DC 180	600	1800	69.91	12.78	16	28.0	36.3	13.6	1.317	1.129	1.112
E2 60 DC 200	600	2000	77.37	14.20	18	28.4	36.6	15.0	1.317	1.129	1.112

Sound levels tested in accordance with ISO 3741.

Bracket positions & dimensions

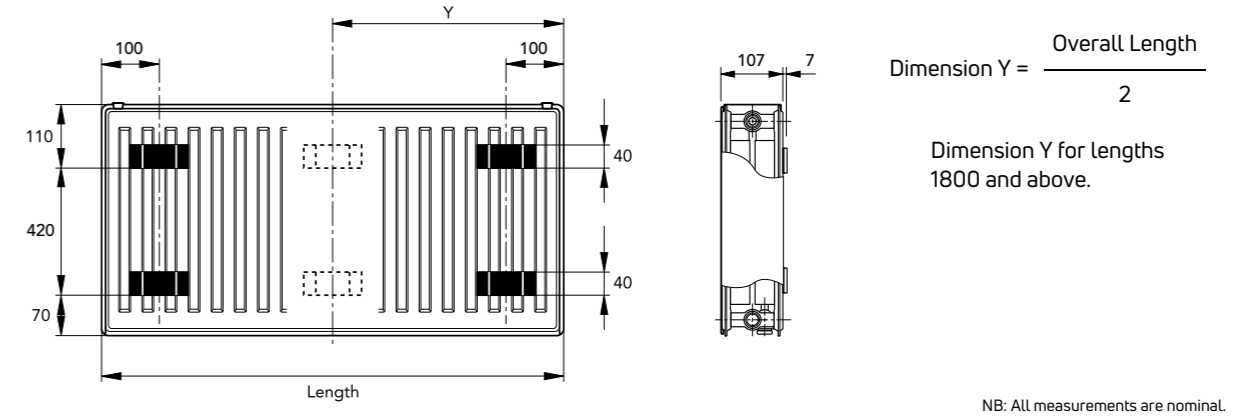

Type 22

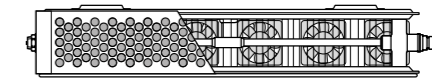

Heat outputs

Nominal Height	Nominal Length (mm)	Operation Mode	Heat Outputs @ ΔT 30°C		Order Code
			Watts	Btu/h	
600mm	400	Static	314	1071	E2 60 DC 40
		Comfort	430	1467	
		Boost	498	1699	
	600	Static	471	1607	E2 60 DC 60
		Comfort	646	2204	
		Boost	746	2545	
	800	Static	628	2143	E2 60 DC 80
		Comfort	861	2938	
		Boost	995	3395	
	1000	Static	785	2678	E2 60 DC 100
		Comfort	1076	3671	
		Boost	1243	4241	
	1200	Static	942	3214	E2 60 DC 120
		Comfort	1291	4405	
		Boost	1491	5087	
	1400	Static	1098	3746	E2 60 DC 140
		Comfort	1506	5138	
		Boost	1741	5940	
	1600	Static	1255	4282	E2 60 DC 160
		Comfort	1723	5879	
		Boost	1989	6786	
	1800	Static	1412	4818	E2 60 DC 180
		Comfort	1938	6612	
		Boost	2238	7636	
2000	Static	1569	5353	E2 60 DC 200	
	Comfort	2153	7346		
	Boost	2486	8482		

PLEASE NOTE: ULOW-E2 should be sized based on comfort mode outputs.

Accessories

Product	Order Code
Twin Entry Valve (Straight)	TEVS
Twin Entry Valve (Angled)	TEVA
Twin Entry Reversible Flow Valve (Straight)	TERFVS
Twin Entry Reversible Flow Valve (Angled)	TERFVA
15mm Nut & Olive Pack (Copper)	NOP15*



*Non-stock - made to order only.

Mounting positions, dimensions & wall brackets

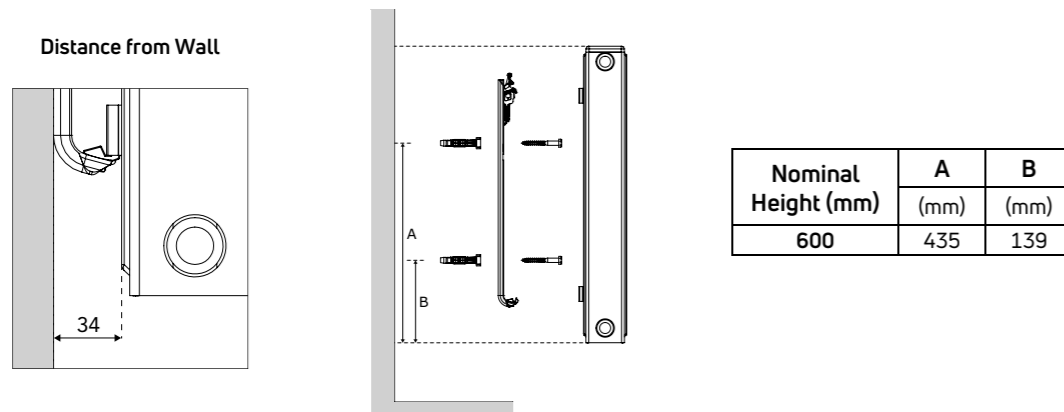



Just because wall space is limited, it doesn't mean that the room has to be left cold and bare. Vertical radiators enable you to have the highest levels of heating comfort, whether it's the classic profile of the VERTICAL (see page 32), the sleek profiles of the FARO V, the smoothness of the KOS V, or the minimalist forms of TINOS V and PAROS V, you can always find the right heat emitter to suit.

And the good news is that our vertical radiators can of course also be combined with horizontal radiators. For a harmonious result, we offer horizontal radiators in the same design for most versions. So you'll find the right solution for every requirement. Vertical panel radiators add to the ambience of any room. Each of our flat front models come in white as standard, with a variety of colours and metallic finishes available to order.

- KOS V has a sleek flat front panel, top grille and side panels. Available in 2 heights, 16 sizes, Type 21 and 22
- FARO V has a finely profiled front panel, top grille and rounded side panels. Available in 2 heights, 16 sizes, Type 21 and 22
- TINOS V is a seamless radiator with a perfectly formed flat front panel. Available in 3 heights, 18 sizes, Type 11 and 21
- PAROS V is a seamless flat front radiator with elegant rounded edges. Available in 3 heights, 18 sizes, Type 11 and 21

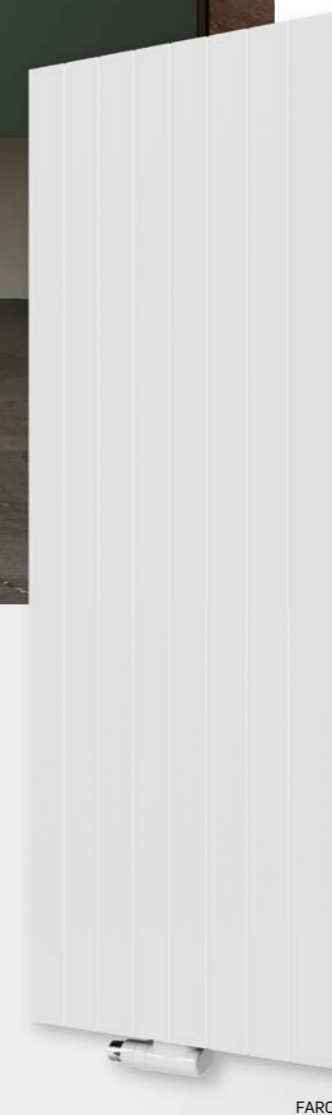

VERTICAL FLAT FRONT RADIATORS

KOS V & FARO V

General specification & technical information

CERTIFICATION
 Manufactured and tested to BS EN 442 & EN 442. Carries the CE & UKCA Mark. Produced under a quality management system - ISO 9001:2015, environmental management system - ISO 14001:2015 and Occupational health and safety management system - ISO 45001:2018.

GUARANTEE
 10 year guarantee from date of purchase against manufacturing defects.

COLOUR
 Finished in white (RAL 9016) as standard. Selected RAL, sanitary, textured and metallic finishes available to order. Please see page 266.

ACCESSORIES
 Touch up paint is available to order.

SYSTEM
 2 pipe pumped indirect domestic and commercial heating applications.

CONNECTIONS
 6 x 1/2" BSP. Please see below.

AIR VENTS
 Air vent and plug packs are included in the packaging.

OPERATING PRESSURES
 Tested to a pressure of 13 bar.
 Working pressure of up to 10 bar.

OPERATING TEMPERATURE
 Maximum 110°C.

DELIVERY
 2 - 5 working days.
 Non-stocked items: 2 - 3 weeks. Colours 4 - 6 weeks.

VALVES
 Please see page 74.

For more general information, please see page 264.

Hydronic connection

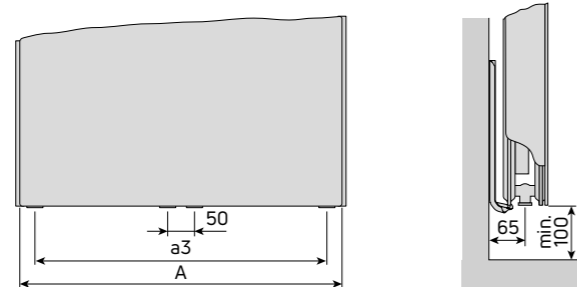

A	300	450	600	750
a3	244	394	544	694

10 bar max.

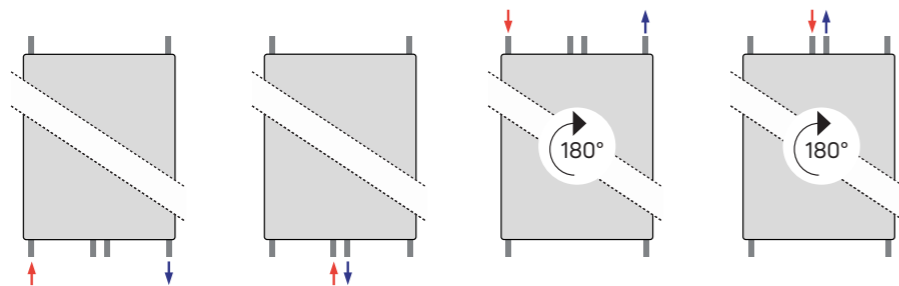

Mounting positions & dimensions

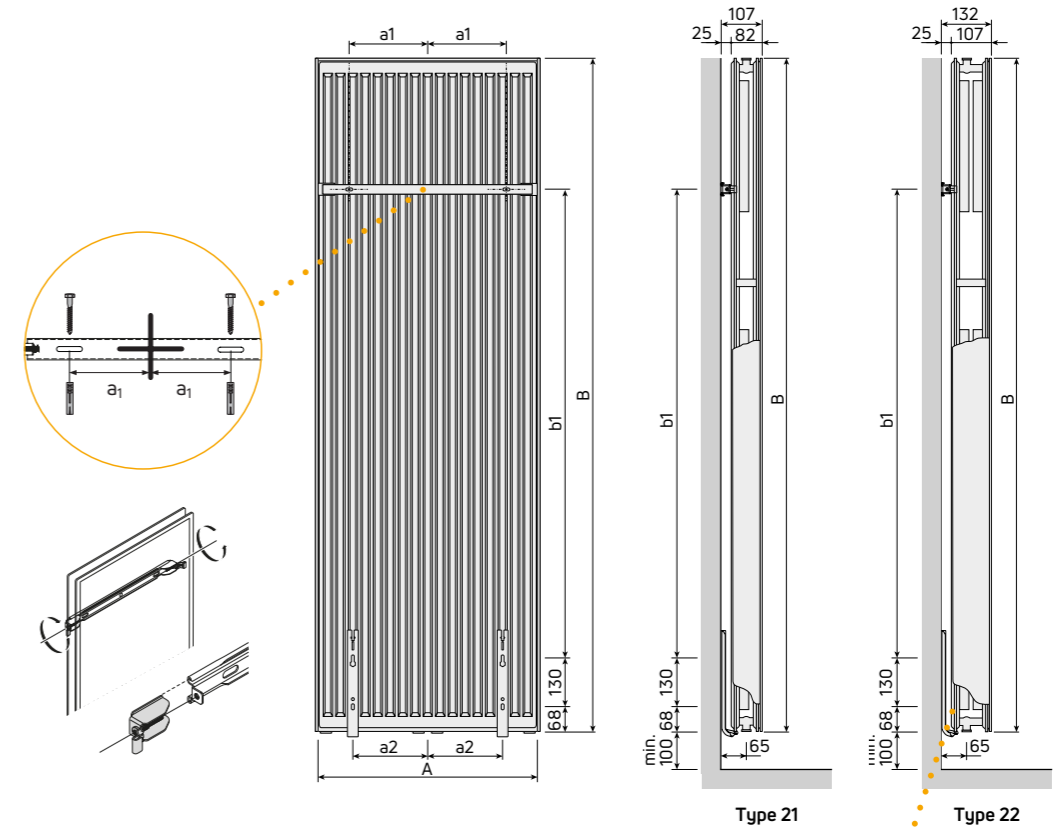

A	300	450	600	750
a1	60	135	210	285
a2	75	125	200	250

B	1800	1950
b1	1252	1402

A = width, B = height
 All dimensions in mm.

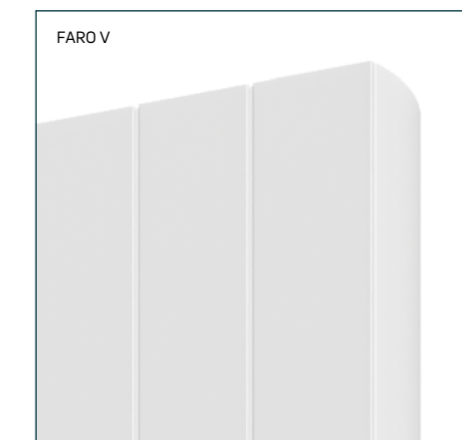
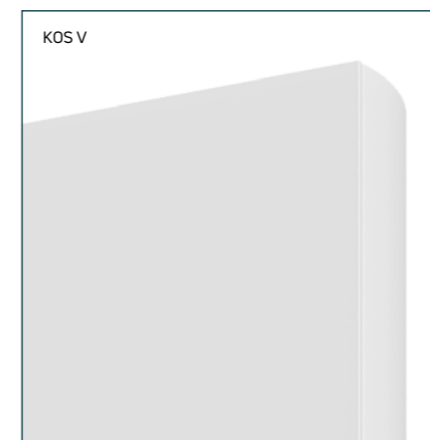
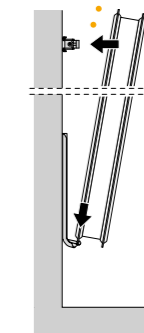

KOS V & FARO V

Heat outputs & technical information

TYPE 21



Nominal Height	Nominal Length (mm)	Heat Outputs @ ΔT 50°C		Heat Outputs @ ΔT 30°C		Weight (kg)	Water Content (l)	n-Coefficients	Order Code	
		Watts	Btu/h	Watts	Btu/h				KOS V	FARO V
1800mm	300	955	3258	495	1689	30.50	4.80	1.2876	KOS180PX30G	FAR180PPX30G*
	450	1389	4739	716	2443	44.05	7.23	1.2965	KOS180PX45G	FAR180PPX45G
	600	1812	6183	930	3173	57.60	9.67	1.3054	KOS180PX60G	FAR180PPX60G
	750	2228	7602	1139	3886	71.15	12.10	1.3143	KOS180PX75G	FAR180PPX75G*
1950mm	300	1008	3439	521	1778	32.78	5.20	1.2905	KOS195PX30G	FAR195PPX30G*
	450	1466	5002	756	2579	47.37	7.80	1.2954	KOS195PX45G*	FAR195PPX45G*
	600	1913	6527	985	3361	61.96	10.40	1.3003	KOS195PX60G*	FAR195PPX60G*
	750	2351	8022	1207	4118	76.55	13.00	1.3052	KOS195PX75G	FAR195PPX75G

TYPE 22

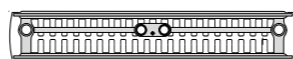

1800mm	300	1148	3917	592	2020	33.75	4.85	1.2958	KOS180PD30G	FAR180PPD30G
	450	1698	5794	873	2979	48.63	7.28	1.3019	KOS180PD45G	FAR180PPD45G
	600	2242	7650	1149	3920	63.52	9.72	1.3079	KOS180PD60G	FAR180PPD60G
	750	2781	9489	1421	4848	78.40	12.15	1.3140	KOS180PD75G	FAR180PPD75G
1950mm	300	1208	4122	624	2129	35.83	5.25	1.2917	KOS195PD30G*	FAR195PPD30G*
	450	1788	6101	921	3142	51.70	7.85	1.2976	KOS195PD45G	FAR195PPD45G*
	600	2360	8052	1213	4139	67.58	10.45	1.3035	KOS195PD60G	FAR195PPD60G
	750	2928	9990	1500	5118	83.45	13.05	1.3095	KOS195PD75G	FAR195PPD75G

*Non-stock - made to order only.

Accessories

Product	Type	Finish	Order Code
VALVE SETS (Includes a nut & olive pack)			
	Angled	White	TVS-DAWH
		Chrome	TVS-DACH
		Matt Stainless Steel	TVS-DAMSS
	Straight	White	TVS-DSWH
		Chrome	TVS-DSCH
		Matt Stainless Steel	TVS-DSMSS
	Angled	White	TVS-AWH
		Chrome	TVS-ACH
		Matt Anthracite Grey	TVS-AMA
		Matt Jet Black	TVS-AMB
	Straight	White	TVS-SWH
		Chrome	TVS-SCH
		Matt Anthracite Grey	TVS-DSMA
		Matt Jet Black	TVS-DSMB
	Angled	White	TVS-VHXAWH
		Chrome	TVS-VHXACH

**Not to be used for top connection

Accessories (cont...)





Product	Length	Radiator (L)	Finish	Order Code
TOWEL BARS				
 MATT BRUSHED TOWEL BAR ON KOS V	For Types 21 & 22		Matt Brushed Stainless Steel	KFBARMBSS300
				KFBARMBSS450
				KFBARMBSS600
				KFBARMBSS750
	Polished Stainless Steel (Chrome look)	KFBARPSS300		
		KFBARPSS450		
		KFBARPSS600		
		KFBARPSS750		









MATT BRUSHED TOWEL BAR ON FARO V

PAROS V & TINOS V

General specification & technical information

-  **CERTIFICATION**
Manufactured and tested to BS EN 442 & EN 442. Carries the CE & UKCA Mark. Produced under a quality management system - ISO 9001:2015, environmental management system - ISO 14001:2015 and Occupational health and safety management system - ISO 45001:2018.
-  **GUARANTEE**
10 year guarantee from date of purchase against manufacturing defects.
-  **COLOUR**
Finished in white (RAL 9016) as standard. Selected RAL, sanitary, textured and metallic finishes available to order. Please see page 266.
-  **ACCESSORIES**
Touch up paint is available to order.
-  **SYSTEM**
2 pipe pumped indirect domestic and commercial heating applications.

-  **CONNECTIONS**
6 x 1/2" BSP. Please see below.
-  **AIR VENTS**
Air vent and plug packs are included in the packaging.
-  **OPERATING PRESSURES**
Tested to a pressure of 13 bar.
Working pressure of up to 10 bar.
-  **OPERATING TEMPERATURE**
Maximum 110°C.
-  **DELIVERY**
Non-stocked item: 2 - 3 weeks.
Colours 4 - 6 weeks.
-  **VALVES**
Please see page 78.

For more general information, please see page 264.

Hydronic connection

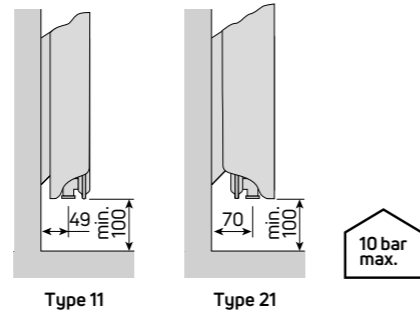
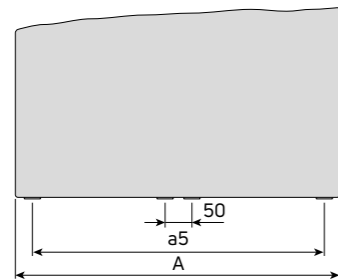

TINOS V - Types 11 & 21

A	325	475	625	775
a5	244	394	544	694

PAROS V - Type 11/ Type 21

A	373/405	523/555	673/705	823/855
a5	244	394	544	694

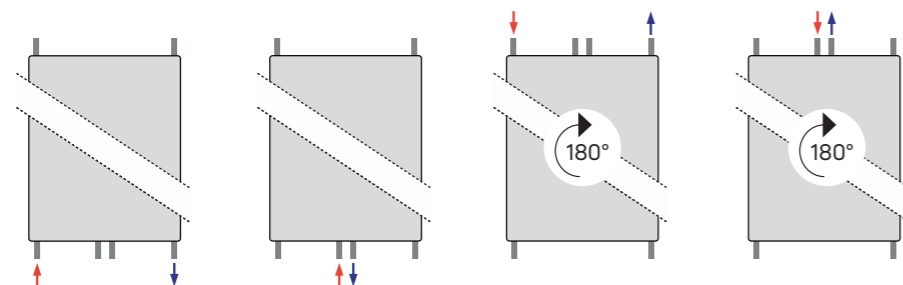

Mounting positions & dimensions

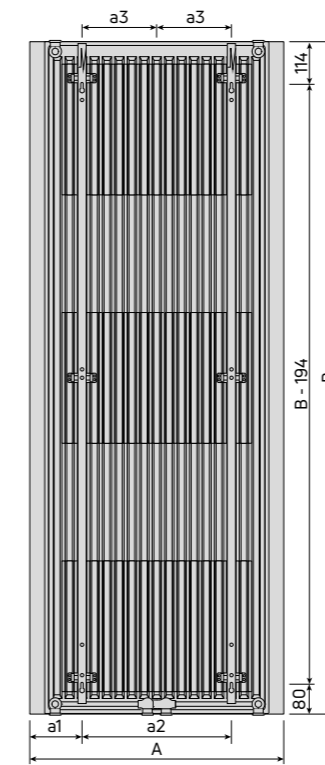

Type 11 & 21

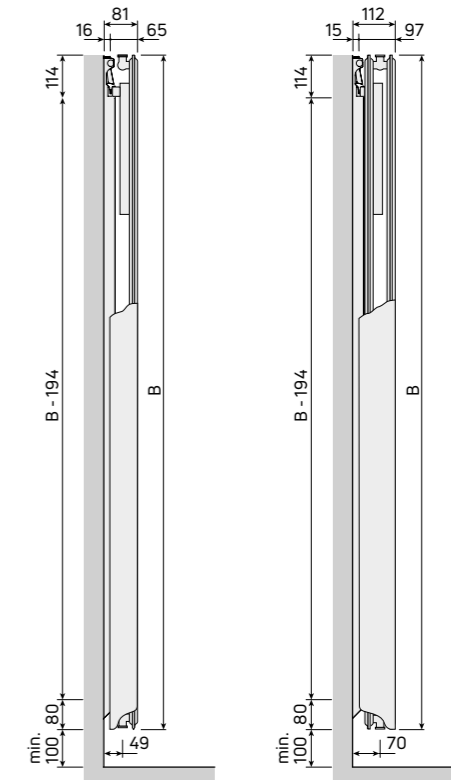

Type 11

Type 21

TINOS V - Type 11

A	325	475	625	775
a1	112	120	112	120
a2	100	234	400	534
a3	50	117	200	267

PAROS V - Type 11

A	373	523	673	823
a1	137	145	137	145
a2	100	234	400	534
a3	50	117	200	267

TINOS V - Type 21

A	325	475	625	775
a1	95	104	95	104
a2	134	266	434	566
a3	67	133	217	283

PAROS V - Type 21

A	405	555	705	855
a1	136	145	136	145
a2	134	266	434	566
a3	67	133	217	283

A = width, B = height. All dimensions in mm.

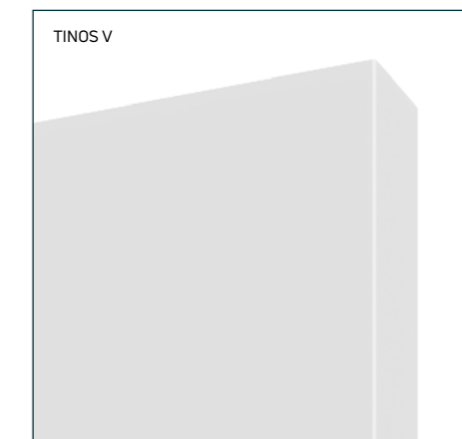

PAROS V & TINOS V

Heat outputs & technical information

TYPE 11

Nominal Height	Nominal Length (mm)		Heat Outputs @ ΔT 50°C		Heat Outputs @ ΔT 30°C		Weight (kg)	Water Content (l)	n-Coefficients	Order Code	
	TINOS V	PAROS V	Watts	Btu/h	Watts	Btu/h				TINOS V	PAROS V
1800mm	325	373	720	2457	378	1290	20.15	2.68	1.2623	TIN180SC32*	PAR180SC38*
	475	523	1042	3555	546	1863	28.42	3.78	1.2645	TIN180SC47*	PAR180SC53*
	625	673	1355	4623	709	2419	36.68	4.92	1.2667	TIN180SC62*	PAR180SC68*
1950mm	325	373	767	2617	403	1375	21.60	2.85	1.2586	TIN195SC32*	PAR195SC38*
	475	523	1110	3787	582	1986	30.40	4.12	1.2639	TIN195SC47*	PAR195SC53*
	625	673	1444	4927	755	2576	39.20	5.38	1.2693	TIN195SC62*	PAR195SC68*
	775	823	1770	6039	923	3149	48.00	6.65	1.2746	TIN195SC77*	PAR195SC83*
2100mm	625	673	1530	5220	803	2740	41.90	5.85	1.2624	TIN210SC62*	PAR210SC68*
	775	823	1876	6401	980	3344	51.35	7.25	1.2716	TIN210SC77*	PAR210SC83*

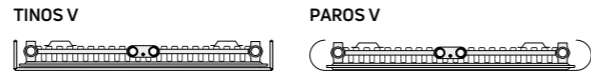

TYPE 21

Nominal Height	Nominal Length (mm)		Heat Outputs @ ΔT 50°C		Heat Outputs @ ΔT 30°C		Weight (kg)	Water Content (l)	n-Coefficients	Order Code	
	TINOS V	PAROS V	Watts	Btu/h	Watts	Btu/h				TINOS V	PAROS V
1800mm	325	405	955	3258	495	1689	31.05	4.80	1.2876	TIN180DX32*	PAR180DX40*
	475	555	1389	4739	716	2443	45.85	7.23	1.2965	TIN180DX47*	PAR180DX55*
	625	705	1812	6183	930	3173	60.63	9.67	1.3054	TIN180DX62*	PAR180DX70*
1950mm	325	405	1008	3439	521	1778	33.42	5.28	1.2905	TIN195DX32*	PAR195DX40*
	475	555	1466	5002	756	2579	49.35	7.80	1.2954	TIN195DX47*	PAR195DX55*
	625	705	1913	6527	985	3361	65.26	10.40	1.3003	TIN195DX62*	PAR195DX70*
	775	855	2351	8022	1207	4118	81.18	13.00	1.3052	TIN195DX77*	PAR195DX85*
2100mm	625	705	2012	6865	1038	3542	69.89	11.13	1.2952	TIN210DX62*	PAR210DX70*
	775	855	2473	8438	1276	4354	86.93	13.90	1.2961	TIN210DX77*	PAR210DX85*



*Non-stock - made to order only.

Accessories

Product	Type	Finish	Order Code
VALVE SETS (Includes a nut & olive pack)			
	Angled	White	TVS-DAWH
		Chrome	TVS-DACH
		Matt Stainless Steel	TVS-DAMSS
	Straight	White	TVS-DSWH
		Chrome	TVS-DSCH
		Matt Stainless Steel	TVS-DSMSS
	Angled	White	TVS-AWH
		Chrome	TVS-ACH
		Matt Anthracite Grey	TVS-AMA
		Matt Jet Black	TVS-AMB
	Straight	White	TVS-SWH
		Chrome	TVS-SCH
		Matt Anthracite Grey	TVS-DSMA
		Matt Jet Black	TVS-DSMB
	Angled	White	TVS-VHXAWH
		Chrome	TVS-VHXACH

**Not to be used for top connection

Accessories (cont...)

Product	Size (mm)	Radiator Length	Finish	Order Code
TOWEL BARS FOR TINOS V				
For Type 11	L = 365 x D = 128	325mm	Matt Brushed Stainless Steel	TBARMBSS11325*
	L = 515 x D = 128	475mm		TBARMBSS11475*
	L = 665 x D = 128	625mm		TBARMBSS11625*
L = 815 x D = 128	775mm	TBARMBSS11775*		
For Type 21	L = 365 x D = 153	325mm		TBARMBSS21325*
	L = 515 x D = 153	475mm		TBARMBSS21475*
	L = 665 x D = 153	625mm	TBARMBSS21625*	
For Type 11	L = 815 x D = 153	775mm	TBARMBSS21775*	
	L = 365 x D = 128	325mm	Polished Stainless Steel (Chrome look)	TBARPSS11325*
	L = 515 x D = 128	475mm		TBARPSS11475*
L = 665 x D = 128	625mm	TBARPSS11625*		
L = 815 x D = 128	775mm	TBARPSS11775*		
For Type 21	L = 365 x D = 153	325mm		TBARPSS21325*
	L = 515 x D = 153	475mm		TBARPSS21475*
	L = 665 x D = 153	625mm	TBARPSS21625*	
	L = 815 x D = 153	775mm	TBARPSS21775*	
TOWEL BARS FOR PAROS V				
For Type 11	L = 413 x D = 128	373mm	Matt Brushed Stainless Steel	PBARMBSS11380*
	L = 563 x D = 128	523mm		PBARMBSS11530*
	L = 713 x D = 128	673mm		PBARMBSS11680*
L = 863 x D = 128	823mm	PBARMBSS11830*		
For Type 21	L = 442 x D = 163	405mm		PBARMBSS21380*
	L = 592 x D = 163	555mm		PBARMBSS21530*
	L = 742 x D = 163	705mm	PBARMBSS21680*	
	L = 892 x D = 163	855mm	PBARMBSS21830*	
For Type 11	L = 413 x D = 128	373mm	Polished Stainless Steel (Chrome look)	PBARPSS11380*
	L = 563 x D = 128	523mm		PBARPSS11530*
	L = 713 x D = 128	673mm		PBARPSS11680*
L = 863 x D = 128	823mm	PBARPSS11830*		
For Type 21	L = 442 x D = 163	405mm		PBARPSS21380*
	L = 592 x D = 163	555mm		PBARPSS21530*
	L = 742 x D = 163	705mm	PBARPSS21680*	
	L = 892 x D = 163	855mm	PBARPSS21830*	

L = Length, D = depth.
*Non-stock - made to order only.



MATT BRUSHED TOWEL BAR ON TINOS V



Design radiators

Using radiators as fashionable as well as functional items has become more popular over recent years. Our design radiators not only look great, they also provide excellent heat outputs, making them perfect for both commercial and domestic applications. Our design radiators are not only beautiful, they're flexible too, with all offering horizontal and vertical installations.

COLUMN and DÉCOR are ideal for large commercial projects or just to add the finishing touch to a domestic project. OPUS is practical and stylish, offering high heat outputs and attractive design.



ELECTRIC MODEL AVAILABLE

Please see page 214

The COLUMN range from MYSON combines elegant style with practical design. At the forefront of the design radiator revolution, the COLUMN will make a focal point in any room. Available in vertical and horizontal models and in a selected range of colour options and sizes, the COLUMN radiator creates a selection of new interior design possibilities for you.

- There are over 60 stocked models available, with heights ranging from 300mm to 2000mm and lengths from 300mm to 1800mm
- Manufactured using a unique laser welding process that virtually eliminates the visible welding points
- The COLUMN radiator is also available as an electric model for instant heat as well as style, please see page 214

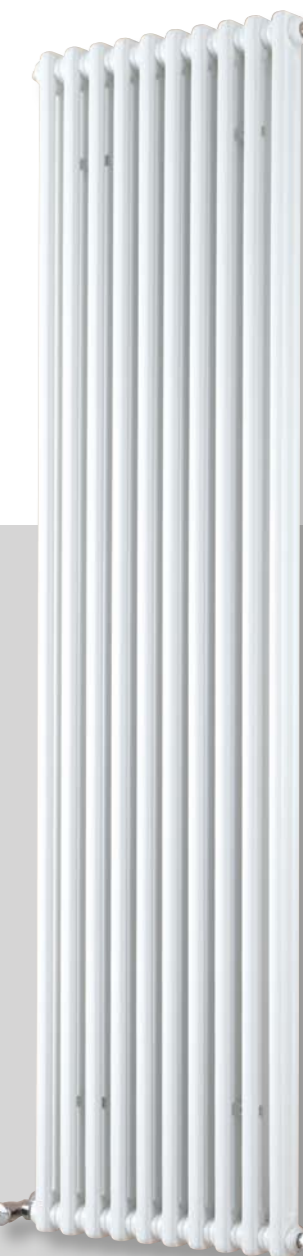

COLUMN VERTICAL









COLUMN HORIZONTAL

COLUMN

COLUMN

General specification & technical information

-  **CERTIFICATION**
Manufactured and tested to BS EN 442 & EN 442. Carries the CE & UKCA Mark. Produced under a quality management system - ISO 9001:2015, environmental management system - ISO 14001:2015 and Occupational health and safety management system - OHSAS 18001.
-  **GUARANTEE**
10 year guarantee from date of purchase against manufacturing defects.
-  **COLOUR**
Standard finish is white (RAL 9016). For other special colour options please see page 266.
-  **MATERIAL**
Manufactured from 1.25mm steel.
-  **ACCESSORIES**
Please see page 87. Touch up paint is available to order.
-  **SYSTEM**
2 pipe pumped indirect domestic and commercial heating applications.
-  **CONNECTIONS**
4 x 1/2" BSP as standard.

-  **AIR VENTS**
Air vent and plug packs are included in the packaging.
-  **OPERATING PRESSURES**
Tested to a pressure of 13 bar. Working pressure of up to 10 bar.
-  **OPERATING TEMPERATURE**
Maximum 100°C.
-  **DELIVERY**
2 - 5 working days. Non-stocked items (& colours): 4 - 5 weeks.
-  **VALVES**
Please see page 225.
-  **BIM**
Visit our website to download the BIM components www.myson.co.uk/bim
-  **SPECIALS**
Visit our website to download the BIM components www.myson.co.uk/bim

For more general information, please see page 264.

Weights & water contents per section

Columns	Nominal Height (mm)											
	300		450		600		750		1800		2000	
	Weight (kg)	Water Content (l)	Weight (kg)	Water Content (l)	Weight (kg)	Water Content (l)	Weight (kg)	Water Content (l)	Weight (kg)	Water Content (l)	Weight (kg)	Water Content (l)
2	-	-	0.75	0.53	0.98	0.66	-	-	2.82	1.72	3.12	1.90
3	0.78	0.57	1.12	0.76	1.46	0.96	1.79	1.15	-	-	-	-
4	1.05	0.75	1.49	1.01	1.94	1.26	2.39	1.51	-	-	-	-

n-Coefficients

Columns	Nominal Height (mm)					
	300	450	600	750	1800	2000
2	-	1.2325	1.2415	-	1.3197	1.3289
3	1.2270	1.2445	1.2604	1.2750	-	-
4	1.2297	1.2564	1.2793	1.2986	-	-

Mounting positions, dimensions & wall brackets

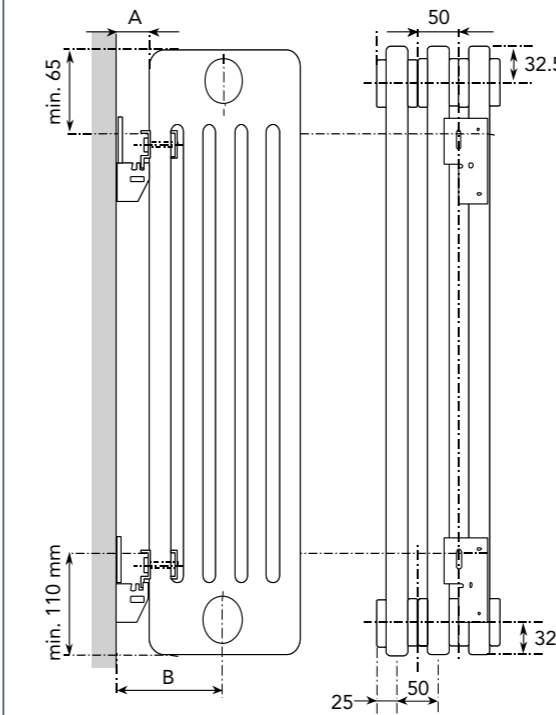

Model	Nominal Depth (mm)	A Distance from Wall (mm)	B Connection Distance from Wall (mm)
2 Column	63	31 / 41	63 / 73
3 Column	101	31 / 41	82 / 92
4 Column	139	31 / 41	101 / 111

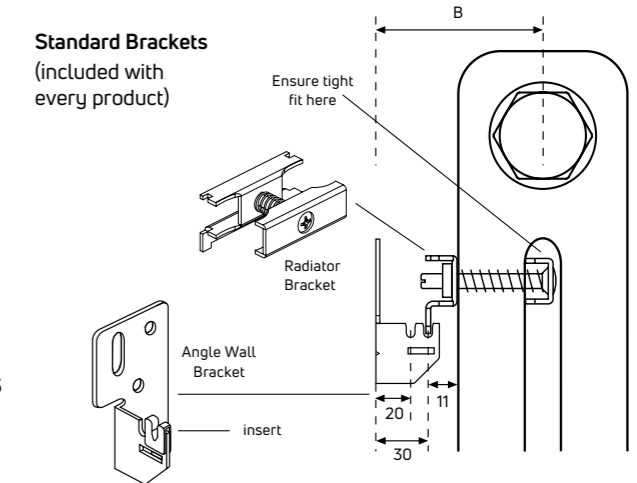

Floor brackets (optional extras)

Clamped Floor Bracket FK*

For use with 2-4 column radiators up to 500mm high

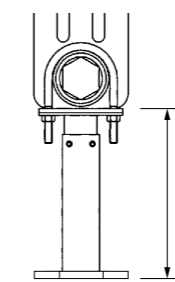
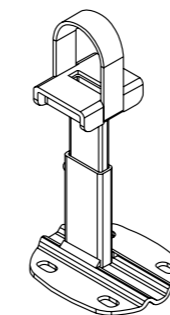

Complete system for free-standing radiators, from 2-4 column up to 500mm height. Finished in white (RAL 9016).

- Comprises;**
- 3mm thick base-plate fixing for either finished or unfinished floors.

Floor Bracket SK*

For use with 2-4 column radiators up to 1000mm high

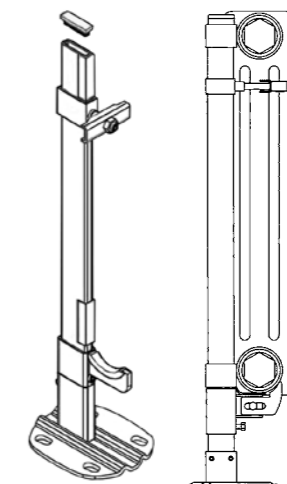

Complete system for free-standing radiators, from 2-4 column up to 1000mm height. Finished in white (RAL 9016).

- Comprises;**
- 3mm thick base-plate for fixing to either finished or unfinished floors
 - upright support 35 x 10 x 1.5mm, fixing set with adjustable bracket, security fixing, anti-vibration insert
 - adjustable bottom support with spacer and security fixing, anti-vibration insert, white plastic end stop for top of upright.

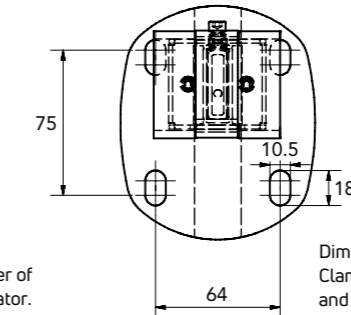

*Please contact Customer Services for correct number of brackets required per radiator.

Dimensions of base-plate for Clamped Floor Bracket FK and Floor Bracket SK

Two-part cover for base-plate in white plastic for Clamped Floor Bracket FK and Floor Bracket SK (Only available in white)

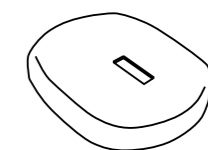

NB: All measurements are nominal.

COLUMN

Technical information (cont...)

Connection options

4 x 1/2" BSP

All MYSON COLUMN radiators are manufactured with an internal baffle to help with water flow. The tapping with the baffle is identified with a red plastic cap, all others being blue. It is important that the water inlet is connected to the tapping identified in red. All MYSON COLUMN radiators are reversible so any of the following connections are possible:

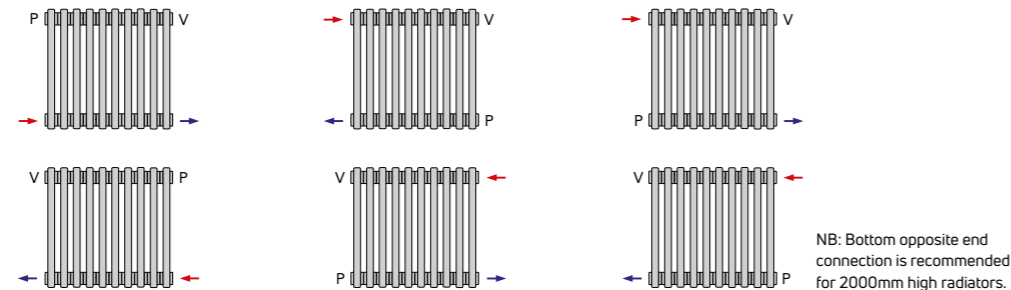

NB: Bottom opposite end connection is recommended for 2000mm high radiators.

Heat outputs

COLUMN vertical - 2 column

Nominal Height	Nominal Width (mm)	No. of Sections	Heat Outputs @ ΔT 50°C		Heat Outputs @ ΔT 30°C		Order Code
			Watts	Btu/h	Watts	Btu/h	
1800mm	300	6	793	2706	401	1368	6 SEC 2180
	400	8	1058	3610	534	1822	8 SEC 2180
	500	10	1322	4511	668	2279	10 SEC 2180
	600	12	1587	5415	802	2736	12 SEC 2180
	750	15	1983	6766	1002	3419	15 SEC 2180
2000mm	300	6	880	3002	443	1512	6 SEC 2200
	400	8	1174	4005	590	2013	8 SEC 2200
	500	10	1468	5010	738	2518	10 SEC 2200
	600	12	1761	6008	886	3023	12 SEC 2200
	750	15	2202	7515	1107	3777	15 SEC 2200

COLUMN horizontal - 2 column

Nominal Height	Nominal Width (mm)	No. of Sections	Heat Outputs @ ΔT 50°C		Heat Outputs @ ΔT 30°C		Order Code
			Watts	Btu/h	Watts	Btu/h	
450mm	600	12	435	1485	230	785	12 SEC 2045
	800	16	580	1980	307	1047	16 SEC 2045
	1000	20	725	2474	384	1310	20 SEC 2045
	1200	24	870	2969	461	1573	24 SEC 2045
	1400	28	1015	3464	538	1836	28 SEC 2045
600mm	1800	36	1305	4454	691	2358	36 SEC 2045
	600	12	564	1925	298	1017	12 SEC 2060
	800	16	752	2567	397	1355	16 SEC 2060
	1000	20	940	3209	496	1692	20 SEC 2060
	1200	24	1128	3850	595	2030	24 SEC 2060
1400	28	1316	4490	694	2368	28 SEC 2060	

COLUMN horizontal - 3 column

Nominal Height	Nominal Width (mm)	No. of Sections	Heat Outputs @ ΔT 50°C		Heat Outputs @ ΔT 30°C		Order Code
			Watts	Btu/h	Watts	Btu/h	
300mm	800	16	566	1933	299	1020	16 SEC 3030
	1000	20	708	2416	374	1276	20 SEC 3030
	1400	28	991	3382	524	1788	28 SEC 3030
	1800	36	1274	4348	673	2296	36 SEC 3030
450mm	600	12	605	2064	319	1088	12 SEC 3045
	800	16	807	2753	426	1454	16 SEC 3045
	1000	20	1009	3443	532	1815	20 SEC 3045
	1200	24	1211	4132	638	2177	24 SEC 3045
	1400	28	1413	4821	745	2542	28 SEC 3045
	1800	36	1818	6203	958	3269	36 SEC 3045

COLUMN

Heat outputs (cont...)

COLUMN horizontal - 3 column (cont...)

Nominal Height	Nominal Width (mm)	No. of Sections	Heat Outputs @ ΔT 50°C		Heat Outputs @ ΔT 30°C		Order Code
			Watts	Btu/h	Watts	Btu/h	
600mm	600	12	780	2661	407	1389	12 SEC 3060
	800	16	1041	3552	542	1849	16 SEC 3060
	1000	20	1301	4439	678	2313	20 SEC 3060
	1200	24	1561	5326	814	2777	24 SEC 3060
	1400	28	1821	6213	949	3238	28 SEC 3060
750mm	600	12	952	3248	492	1679	12 SEC 3075
	800	16	1270	4335	656	2238	16 SEC 3075
	1000	20	1588	5418	820	2798	20 SEC 3075
	1200	24	1905	6500	984	3357	24 SEC 3075
	1400	28	2223	7586	1148	3917	28 SEC 3075

COLUMN horizontal - 4 column

Nominal Height	Nominal Width (mm)	No. of Sections	Heat Outputs @ ΔT 50°C		Heat Outputs @ ΔT 30°C		Order Code
			Watts	Btu/h	Watts	Btu/h	
300mm	800	16	729	2487	386	1317	16 SEC 4030
	1000	20	911	3108	482	1645	20 SEC 4030
	1400	28	1276	4354	675	2303	28 SEC 4030
	1800	36	1640	5596	868	2962	36 SEC 4030
450mm	600	12	776	2648	404	1378	12 SEC 4045
	800	16	1035	3531	539	1839	16 SEC 4045
	1000	20	1294	4415	674	2300	20 SEC 4045
	1200	24	1552	5295	809	2760	24 SEC 4045
	1400	28	1811	6179	944	3221	28 SEC 4045
	1800	36	2328	7943	1213	4139	36 SEC 4045
600mm	600	12	997	3402	515	1757	12 SEC 4060
	800	16	1329	4537	686	2341	16 SEC 4060
	1000	20	1662	5671	858	2927	20 SEC 4060
	1200	24	1994	6805	1030	3514	24 SEC 4060
	1400	28	2327	7939	1201	4098	28 SEC 4060
750mm	600	12	1213	4139	620	2115	12 SEC 4075
	800	16	1618	5521	827	2822	16 SEC 4075
	1000	20	2023	6902	1034	3528	20 SEC 4075
	1200	24	2427	8281	1241	4234	24 SEC 4075
	1400	28	2832	9663	1448	4941	28 SEC 4075

Accessories

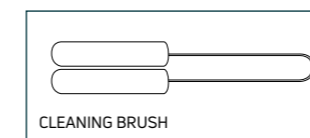

CLEANING BRUSH

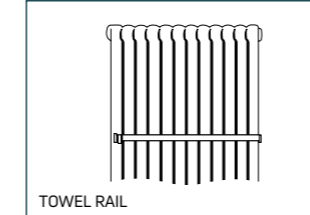

TOWEL RAIL

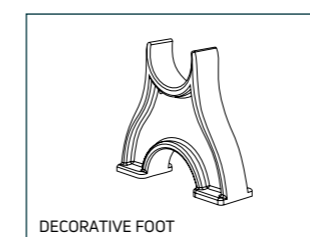

DECORATIVE FOOT

Product	Order Code
Microfibre Cleaning Brush	COLUMNBRUSH2
Towel Rail - Clip-on to fit all radiators up to 1000mm wide (20 sections)	12SECRAIL* 16SECRAIL* 20SECRAIL*
Decorative Foot** (not load bearing)	COLDECFOOT
Base-Plate Cover** - For use with both floor brackets	COVERSKFK
Clamped Floor Bracket FK	FK1021

Floor Bracket SK	Height of Bracket (mm)		Height of Radiator (mm)	Order Code
	460	610		
	300	450	300	SK20046*
	610	450	450	SK20061
	760	600	600	SK20076
	910	750	750	SK20091

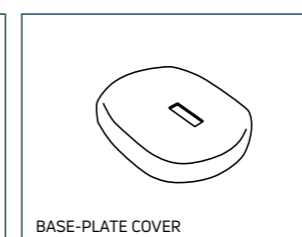

BASE-PLATE COVER

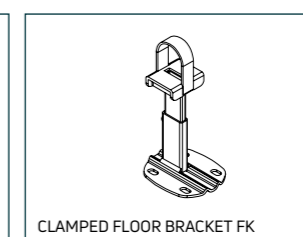

CLAMPED FLOOR BRACKET FK

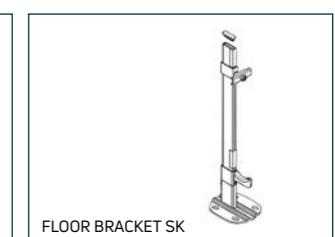

FLOOR BRACKET SK

*Non-stock - made to order only.
**Supplied in white (RAL 9016) only.



ELECTRIC MODEL AVAILABLE
Please see page 212

The MYSON DÉCOR range has played a leading role in the world of interior design over the past decade. It treats radiators as decorative items as well as heating devices. With a range of sizes and tube designs available, the MYSON DÉCOR range offers a stunning alternative to mainstream radiators.

- Comes in horizontal, vertical and plinth models, in a range of heights from 155mm to 2000mm and lengths from 308mm to 2200mm
- Available in special made to order sizes and selected colours to suit all spaces and tastes
- Electric model also available, please see page 212



DÉCOR

General specification & technical information

CERTIFICATION
Manufactured and tested to BS EN 442 & EN 442. Carries the CE & UKCA Mark. Produced under a quality management system - ISO 9001:2015, environmental management system - ISO 14001:2015 and Occupational health and safety management system - OHSAS 18001.

GUARANTEE
10 year guarantee from date of purchase against manufacturing defects.

COLOUR
Standard finish is white (RAL 9016). For other special colour options please see page 266.

MATERIAL
Header tubes: Manufactured from 1.5mm steel.
Heating tubes: Manufactured from 1.25mm steel.
KH models: Manufactured from 1.5mm steel.

ACCESSORIES
Touch up paint is available to order.

SYSTEM
2 pipe pumped indirect domestic and commercial heating applications.

CONNECTIONS
2 & 4 x 1/2" BSP as standard.

AIR VENTS
Air vent and plug packs are included in the packaging.

OPERATING PRESSURES
All models (excl. KH models): Tested to a pressure of 5.2 bar. Working pressure of up to 4 bar.
KH models: Tested to a pressure of 8 bar. Working pressure of up to 5 bar.

OPERATING TEMPERATURE
Maximum 100°C.

DELIVERY
2 - 5 working days.
Non-stocked items (& colours): 4 - 5 weeks.

VALVES
Please see page 225.

BIM
Visit our website to download the BIM components www.myson.co.uk/bim

SPECIALS
Please refer to the full DÉCOR technical guide for special sizes and colour options.

For more general information, please see page 264.

Weights & water contents per metre length

Type	Nominal Height (mm)									
	155		305		430 - 455		574 - 605		755	
	Weight (kg)	Water Content (l)	Weight (kg)	Water Content (l)	Weight (kg)	Water Content (l)	Weight (kg)	Water Content (l)	Weight (kg)	Water Content (l)
KH11	-	-	-	-	19.85	3.33	26.15	4.44	-	-
KH22	-	-	-	-	36.93	6.66	49.01	8.88	-	-
V10	-	-	-	-	-	-	-	-	-	-
V20	-	-	-	-	-	-	-	-	-	-
H28	10.52	2.96	21.04	5.92	-	-	-	-	-	-
H11	-	-	-	-	15.78	4.44	21.04	5.92	26.30	7.40
H21	-	-	-	-	24.78	7.80	33.04	10.40	41.30	13.00
H22	-	-	-	-	30.18	7.80	40.24	10.40	50.30	13.00
TS4	-	-	-	-	-	-	-	-	-	-

Weights & water contents per tube

Type	Nominal Height (mm)					
	1600		1800		2000	
	Weight (kg)	Water Content (l)	Weight (kg)	Water Content (l)	Weight (kg)	Water Content (l)
KH11	-	-	-	-	-	-
KH22	-	-	-	-	-	-
V10	2.63	1.08	2.93	1.19	3.23	1.30
V20	5.03	1.97	5.63	2.20	6.23	2.42
H28	-	-	-	-	-	-
H11	-	-	-	-	-	-
H21	-	-	-	-	-	-
H22	-	-	-	-	-	-
TS4	-	-	2.75	1.10	3.05	1.22

n-Coefficients

Type	Nominal Height (mm)							
	155	305	430 - 455	574 - 605	755	1600	1800	2000
KH11	-	-	1.300	1.320	-	-	-	-
KH22	-	-	1.350	1.370	-	-	-	-
V10	-	-	-	-	-	1.317	1.323	1.320
V20	-	-	-	-	-	1.318	1.320	1.321
H28	1.210	1.245	-	-	-	-	-	-
H11	-	-	1.262	1.266	1.269	-	-	-
H21	-	-	1.288	1.289	1.289	-	-	-
H22	-	-	1.300	1.299	1.298	-	-	-
TS4	-	-	-	-	-	-	1.303	1.317

Connection options

2 & 4 x 1/2" BSP

IMPORTANT: MYSON DÉCOR radiators are high performance, universal radiators that come with a choice of connection options.

H11, H21, H22, H28, KH11 & KH22

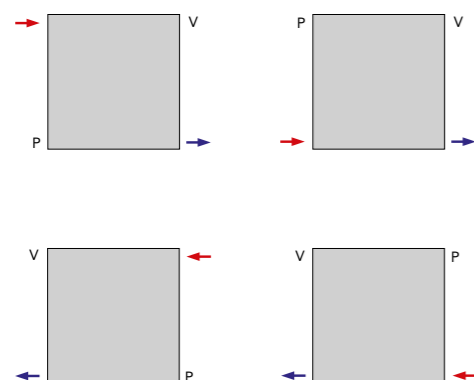

TS4

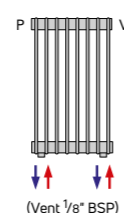

V10 & V20

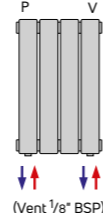

NB: FOR KH11 & KH22 ONLY: Flow separation screws are supplied with each radiator and each screw must be fastened and tightened. Failure to correctly fasten the screws will result in the product not functioning correctly and may cause the product to leak. Please refer to the installation instructions on our website for more information. TBSE (Top Bottom Same End) only available for KH models.

Mounting positions, dimensions & wall brackets - DÉCOR KH models

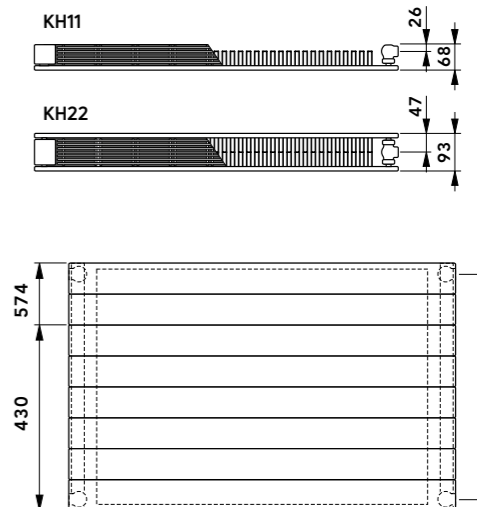
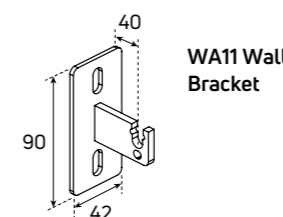
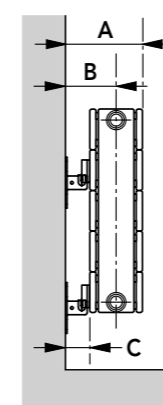

Radiator Models	Overall Height (mm)	A (mm)	B (mm)	C (mm)
KH11	430 - 574	87	45	19
KH22	430 - 574	135	89	42

Overall Height (mm)	430	574
Connection Spacing C (mm)	390	534

*Lengths 600 to 1600mm = 4 brackets. Lengths 1800 to 2000mm = 6 brackets.

NB: All measurements are nominal.

DÉCOR

Technical information (cont...)

DESIGN RADIATORS

DESIGN RADIATORS

Mounting positions, dimensions & wall brackets - DÉCOR V10 & V20 models

Connection Dimensions

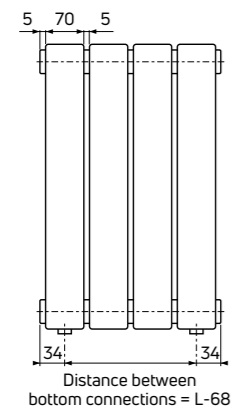

V10

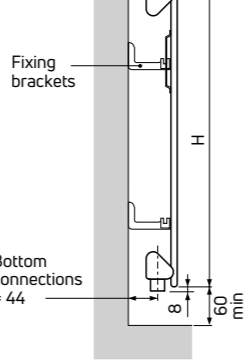

V20

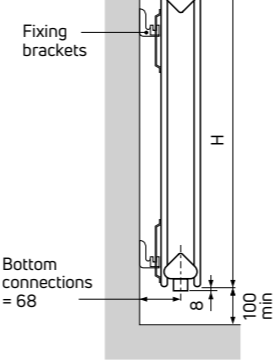

Wall Bracket Dimensions

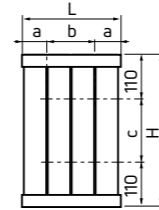
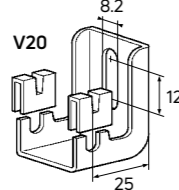
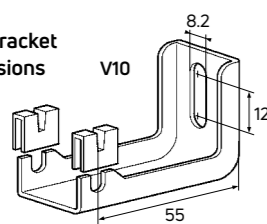

Wall Bracket Positioning

a = 77.5mm
 b = L - (2 x a)
 c = H - 220
 L = (Number of tubes x 75) + 5mm
 H = Height

Mounting positions, dimensions & wall brackets - DÉCOR H28 floor model

Connection Dimensions

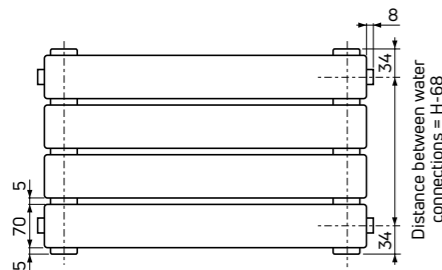

H28

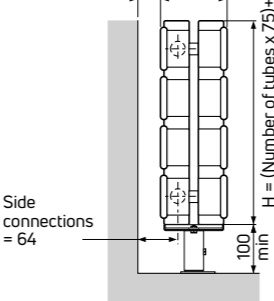

Floor Mounting Dimensions

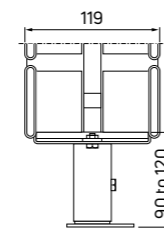

Adjustable Foot

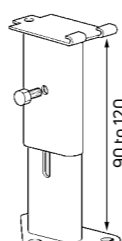

(Factory fitted)

Floor Mounting Dimensions Length from 1000mm to 1200mm

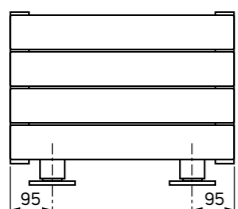

Floor Mounting Dimensions Length from 1400mm to 2200mm

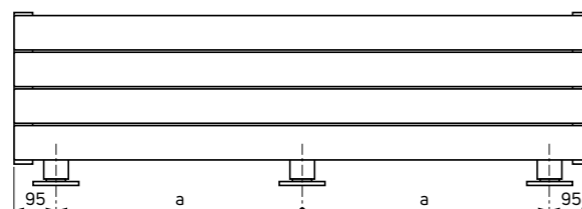

$$a = \frac{L-190}{2}$$

H = Height (mm)
 L = Length (mm)

Mounting positions, dimensions & wall brackets - DÉCOR H11, H21, H22 & H28 wall models

Connection Dimensions

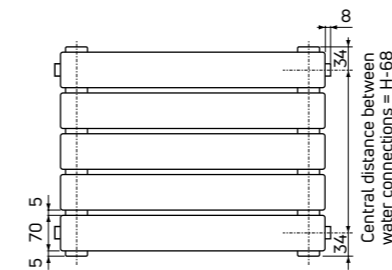

H11

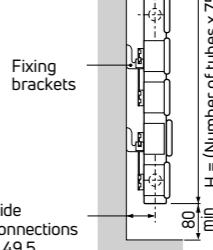

H21

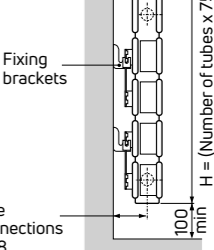

H = Height (mm)
 L = Length (mm)

H22

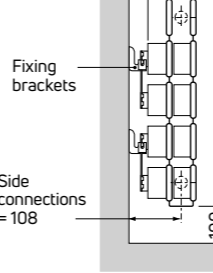

H28 Wall

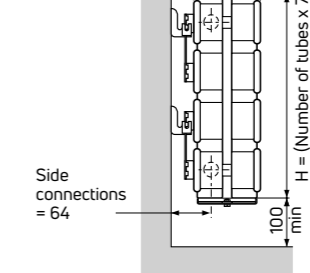

Wall Bracket Dimensions

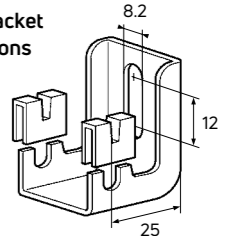

Wall Bracket Positioning Length from 600mm to 1200mm

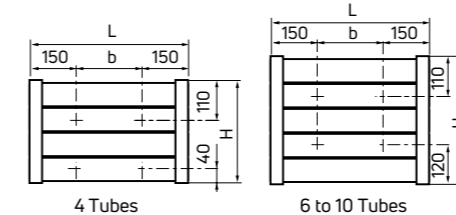

$$b = L - 300$$

$$H = (\text{Number of tubes} \times 75) + 5\text{mm}$$

Wall Bracket Positioning Length from 1400mm to 2200mm

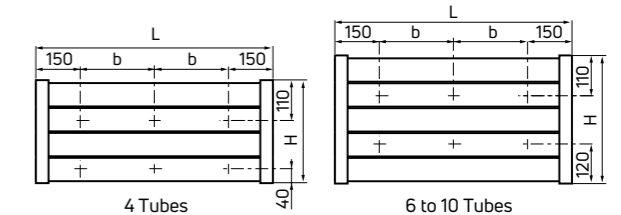

$$b = \frac{L-300}{2}$$

$$H = (\text{Number of tubes} \times 75) + 5\text{mm}$$

$$L = \text{Length}$$

Mounting positions, dimensions & wall brackets - DÉCOR TS4 model

Connection Dimensions

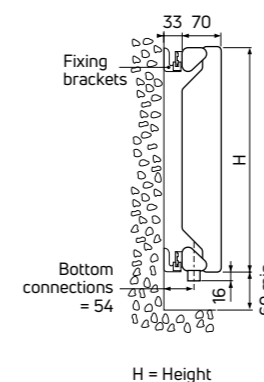
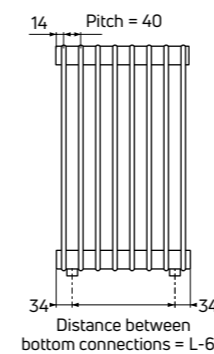

H = Height

Wall Bracket Positioning

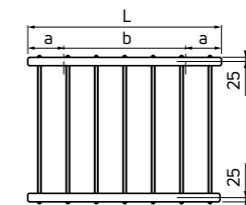

a = 74mm
 b = L - (2 x a)
 L = Length

Wall Bracket Dimensions

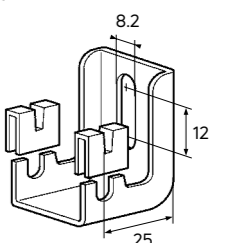

NB: All measurements are nominal.

DÉCOR

Heat outputs

DÉCOR KH11 horizontal



Nominal Height	Nominal Length (mm)	No. of Tubes	Heat Outputs @ ΔT 50°C		Heat Outputs @ ΔT 30°C		Order Code
			Watts	Btu/h	Watts	Btu/h	
430mm	600	6	456	1556	235	802	KH11 0430 0600*
	800	6	608	2074	313	1068	KH11 0430 0800
	1000	6	760	2593	391	1334	KH11 0430 1000*
	1200	6	912	3112	469	1600	KH11 0430 1200*
	1400	6	1064	3630	547	1866	KH11 0430 1400*
	1800	6	1368	4668	704	2402	KH11 0430 1800*
574mm	600	8	553	1887	282	962	KH11 0574 0600*
	800	8	737	2515	376	1283	KH11 0574 0800*
	1000	8	921	3142	470	1604	KH11 0574 1000*
	1200	8	1105	3770	564	1924	KH11 0574 1200*
	1400	8	1289	4398	658	2245	KH11 0574 1400
	1800	8	1658	5657	846	2887	KH11 0574 1800
	2000	8	1842	6285	940	3207	KH11 0574 2000

DÉCOR KH22 horizontal

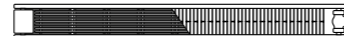

430mm	600	6	806	2750	405	1382	KH22 0430 0600*
	800	6	1074	3664	540	1842	KH22 0430 0800*
	1000	6	1343	4582	675	2303	KH22 0430 1000*
	1200	6	1612	5500	810	2764	KH22 0430 1200*
	1400	6	1880	6415	945	3224	KH22 0430 1400
	1800	6	2417	8247	1215	4146	KH22 0430 1800*
574mm	600	8	955	3258	474	1617	KH22 0574 0600*
	800	8	1274	4347	632	2156	KH22 0574 0800*
	1000	8	1592	5432	790	2695	KH22 0574 1000*
	1200	8	1910	6517	948	3235	KH22 0574 1200*
	1400	8	2229	7605	1106	3774	KH22 0574 1400
	1800	8	2866	9779	1422	4852	KH22 0574 1800*
	2000	8	3184	10864	1580	5391	KH22 0574 2000*

DÉCOR V10 vertical

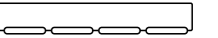

Nominal Height	Nominal Length (mm)	No. of Tubes	Heat Outputs @ ΔT 50°C		Heat Outputs @ ΔT 30°C		Order Code
			Watts	Btu/h	Watts	Btu/h	
1600mm	605	8	1056	3603	534	1822	8V10160
1800mm	455	6	892	3044	451	1539	6V10180
	605	8	1190	4060	602	2054	8V10180
	755	10	1487	5074	752	2566	10V10180
2000mm	455	6	991	3381	504	1720	6V10200*
	605	8	1322	4511	672	2293	8V10200*
	755	10	1652	5637	840	2866	10V10200*

DÉCOR V20 vertical

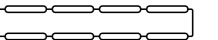

1600mm	605	8	1606	5480	817	2788	8V20160*
1800mm	455	6	1339	4569	682	2327	6V20180
	605	8	1786	6094	909	3102	8V20180
	755	10	2232	7616	1136	3876	10V20180
2000mm	455	6	1474	5029	750	2559	6V20200*
	605	8	1965	6705	1000	3412	8V20200
	755	10	2456	8380	1250	4265	10V20200

DÉCOR H28 floor

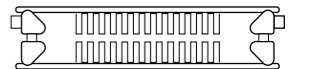

155mm	1000	2	682	2327	366	1249	2H28100*
	1400	2	955	3258	512	1747	2H28140
	1800	2	1228	4190	659	2249	2H28180*
	2200	2	1500	5118	805	2747	2H28220*
305mm	1000	4	1195	4077	641	2187	4H28100
	1400	4	1673	5708	897	3061	4H28140
	1800	4	2151	7339	1154	3937	4H28180
	2200	4	2629	8970	1410	4811	4H28220*

DÉCOR H28 wall

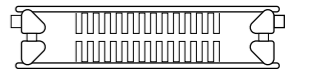

305mm	1000	4	1195	4077	641	2187	4H28100W*
	1400	4	1673	5708	897	3061	4H28140W*
	1800	4	2151	7339	1154	3937	4H28180W*
	2200	4	2629	8970	1410	4811	4H28220W*

*Non-stock - made to order only.

DÉCOR

Heat outputs (cont...)

DÉCOR H11 horizontal



Nominal Height	Nominal Length (mm)	No. of Tubes	Heat Outputs @ ΔT 50°C		Heat Outputs @ ΔT 30°C		Order Code
			Watts	Btu/h	Watts	Btu/h	
455mm	600	6	478	1631	251	856	6H11060
	700	6	558	1904	293	1000	6H11070*
	800	6	638	2177	335	1143	6H11080*
	900	6	717	2446	376	1283	6H11090*
	1000	6	797	2719	419	1430	6H11100*
	1200	6	956	3262	503	1716	6H11120*
	1400	6	1116	3808	587	2003	6H11140*
	1600	6	1275	4350	670	2286	6H11160*
	1800	6	1435	4896	754	2573	6H11180*
	2000	6	1594	5439	838	2859	6H11200*
605mm	600	8	602	2054	317	1082	8H11060
	700	8	702	2395	370	1262	8H11070*
	800	8	802	2736	422	1440	8H11080
	900	8	903	3081	475	1621	8H11090*
	1000	8	1003	3422	528	1802	8H11100*
	1200	8	1204	4108	634	2163	8H11120*
	1400	8	1404	4790	739	2521	8H11140*
	1600	8	1605	5476	845	2883	8H11160*
	1800	8	1805	6159	950	3241	8H11180*
	2000	8	2006	6844	1056	3603	8H11200*
755mm	600	10	721	2460	379	1293	10H11060
	700	10	841	2869	442	1508	10H11070*
	800	10	962	3282	506	1726	10H11080*
	900	10	1082	3692	569	1941	10H11090*
	1000	10	1202	4101	632	2156	10H11100*
	1200	10	1442	4920	758	2586	10H11120*
	1400	10	1683	5742	885	3020	10H11140
	1600	10	1923	6561	1011	3450	10H11160*
	1800	10	2164	7384	1138	3883	10H11180*
	2000	10	2404	8202	1264	4313	10H11200

DÉCOR H21 horizontal



455mm	600	6	678	2313	355	1211	6H21060*
	700	6	791	2699	414	1413	6H21070
	800	6	904	3084	473	1614	6H21080*
	900	6	1017	3470	532	1815	6H21090*
	1000	6	1130	3856	591	2016	6H21100*
	1200	6	1356	4627	709	2419	6H21120*
	1400	6	1582	5398	827	2822	6H21140*
	1600	6	1808	6169	946	3228	6H21160*
	1800	6	2034	6940	1064	3630	6H21180*
	2000	6	2260	7711	1182	4033	6H21200
605mm	600	8	833	2842	435	1484	8H21060
	700	8	972	3316	508	1733	8H21070*
	800	8	1110	3787	580	1979	8H21080*
	900	8	1249	4262	653	2228	8H21090*
	1000	8	1388	4736	725	2474	8H21100*
	1200	8	1666	5684	870	2968	8H21120*
	1400	8	1943	6630	1015	3463	8H21140*
	1600	8	2221	7578	1160	3958	8H21160*
	1800	8	2498	8523	1305	4453	8H21180*
	2000	8	2776	9472	1450	4947	8H21200

DÉCOR H21 horizontal (cont...)



Nominal Height	Nominal Length (mm)	No. of Tubes	Heat Outputs @ ΔT 50°C		Heat Outputs @ ΔT 30°C		Order Code
			Watts	Btu/h	Watts	Btu/h	
755mm	600	10	978	3337	511	1744	10H21060
	700	10	1141	3893	596	2034	10H21070
	800	10	1304	4449	682	2327	10H21080
	900	10	1467	5005	767	2617	10H21090
	1000	10	1630	5562	852	2907	10H21100*
	1200	10	1956	6674	1022	3487	10H21120
	1400	10	2282	7786	1193	4071	10H21140
	1600	10	2608	8898	1363	4651	10H21160
	1800	10	2934	10011	1534	5234	10H21180
	2000	10	3260	11123	1704	5814	10H21200

DÉCOR H22 horizontal

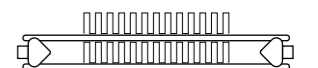

455mm	600	6	833	2842	433	1477	6H22060*
	700	6	972	3316	505	1723	6H22070*
	800	6	1110	3787	578	1972	6H22080*
	900	6	1249	4262	650	2218	6H22090*
	1000	6	1388	4736	722	2463	6H22100*
	1200	6	1666	5684	866	2955	6H22120*
	1400	6	1943	6630	1011	3450	6H22140*
	1600	6	2221	7578	1155	3941	6H22160*
	1800	6	2498	8523	1300	4436	6H22180*
	2000	6	2776	9472	1444	4927	6H22200*
605mm	600	8	1027	3504	534	1822	8H22060*
	700	8	1198	4088	623	2126	8H22070
	800	8	1369	4671	712	2429	8H22080*
	900	8	1540	5254	801	2733	8H22090
	1000	8	1711	5838	890	3037	8H22100*
	1200	8	2053	7005	1068	3644	8H22120*
	1400	8	2395	8172	1246	4251	8H22140*
	1600	8	2738	9342	1424	4859	8H22160*
	1800	8	3080	10509	1602	5466	8H22180*
	2000	8	3422	11676	1780	6073	8H22200
755mm	600	10	1206	4115	628	2143	10H22060*
	700	10	1407	4801	732	2498	10H22070*
	800	10	1608	5486	837	2856	10H22080*
	900	10	1809	6172	941	3211	10H22090
	1000	10	2010	6858	1046	3569	10H22100*
	1200	10	2412	8230	1255	4282	10H22120*
	1400	10	2814	9601	1464	4995	10H22140*
	1600	10	3216	10973	1674	5712	10H22160*
	1800	10	3618	12345	1883	6425	10H22180*
	2000	10	4020	13716	2092	7138	10H22200*

DÉCOR TS4

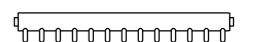

1800mm	308	8	832	2839	423	1443	8TS4180*
	428	11	1144	3903	581	1982	11TS4180*
	508	13	1352	4613	687	2344	13TS4180
	628	16	1664	5678	845	2883	16TS4180
2000mm	308	8	936	3194	480	1638	8TS4200
	428	11	1287	4391	660	2252	11TS4200
	508	13	1521	5190	780	2661	13TS4200*
	628	16	1872	6387	960	3276	16TS4200*

*Non-stock - made to order only.



OPUS is a contemporary round tube radiator. It has a simple, yet sleek design that blends effortlessly into its surrounding. It is a stylish and functional radiator, with high heat outputs, and comes in a range of sizes and models. Standard colour is an attractive white (RAL 9016) but other colour options are available, see page 266.

- OPUS is available in eight different sizes
- Widths range from 324mm - 1000mm
- Heights vary from 468mm - 2000mm



OPUS HORIZONTAL

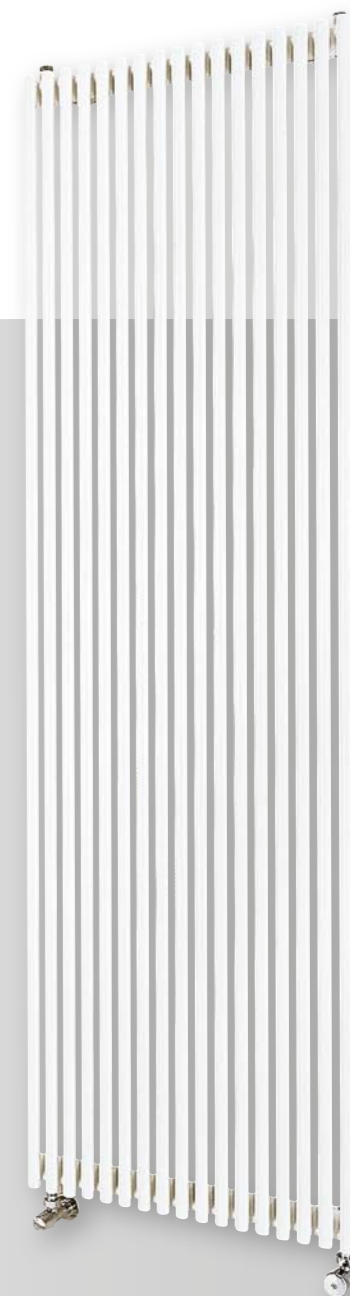











OPUS VERTICAL



OPUS

General specification & technical information

-  **CERTIFICATION**
Manufactured and tested to BS EN 442 & EN 442. Carries the CE & UKCA Mark. Produced under a quality management system - ISO 9001:2015, environmental management system - ISO 14001:2015 and Occupational health and safety management system - OHSAS 18001.
-  **GUARANTEE**
10 year guarantee from date of purchase against manufacturing defects.
-  **COLOUR**
Standard finish is white (RAL 9016). For other special colour options please see page 266.
-  **MATERIAL**
Manufactured from steel.
-  **SYSTEM**
2 pipe pumped indirect domestic and commercial heating applications.

-  **CONNECTIONS**
Vertical: 6 x 1/2" BSP. Horizontal: 4 x 1/2" BSP.
-  **AIR VENTS**
Included in the packaging.
-  **OPERATING PRESSURES**
Tested to a pressure of 13 bar. Working pressure of up to 10 bar.
-  **OPERATING TEMPERATURE**
Maximum 100°C.
-  **DELIVERY**
Non-stocked item: 4 - 5 weeks.
-  **VALVES**
Please see page 225.

For more general information, please see page 264.

Weights & water contents per metre length

Type	Weight (kg)	Water Content (l)
MEZV1	14.49	6.93
MEZV2	20.93	10.01
MEZV3	27.37	13.09
MEZV4	33.81	16.17
MEZH1	7.20	3.32
MEZH2	9.28	4.34
MEZH3	12.01	5.54
MEZH4	15.38	7.24

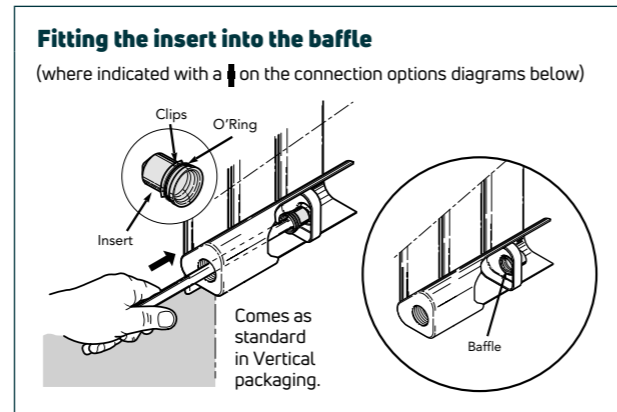

Connection options

6 x 1/2" BSP

Vertical
(Universal Connection)

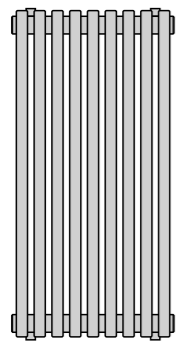

Vertical connection options without the need for an insert

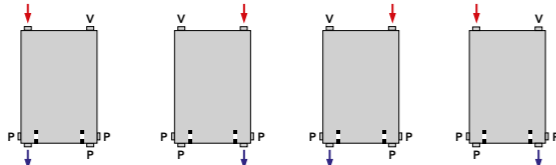

Vertical connection options which require an insert

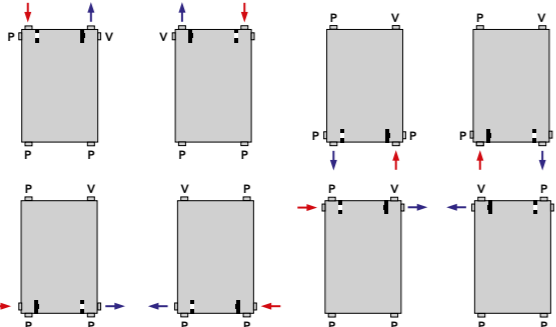

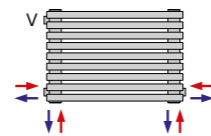

4 x 1/2" BSP

Horizontal



Key

-  Baffle Without Insert
-  Baffle With Insert (manual insertion required on universal connections - see above)

Mounting positions, dimensions & wall brackets

OPUS Horizontal

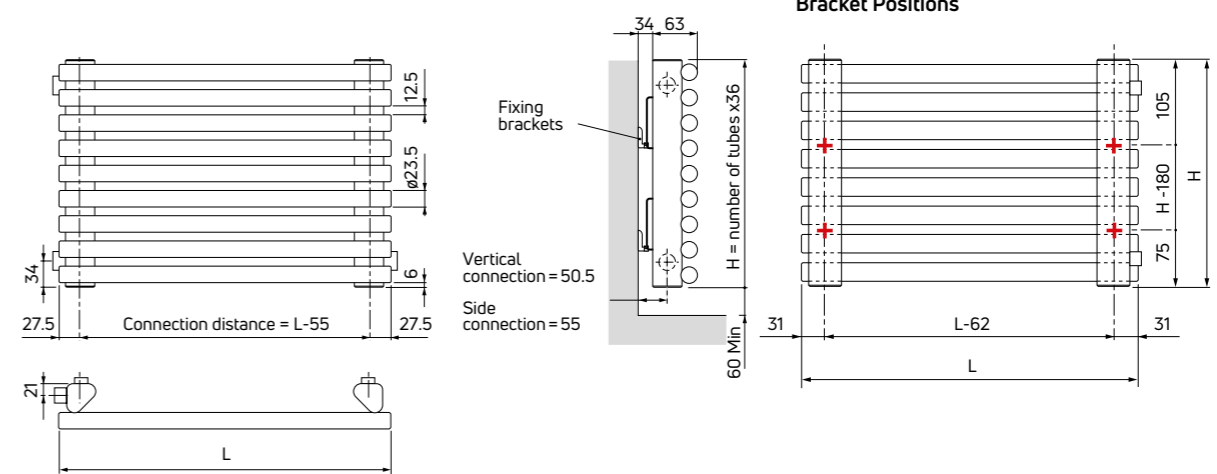

OPUS Vertical

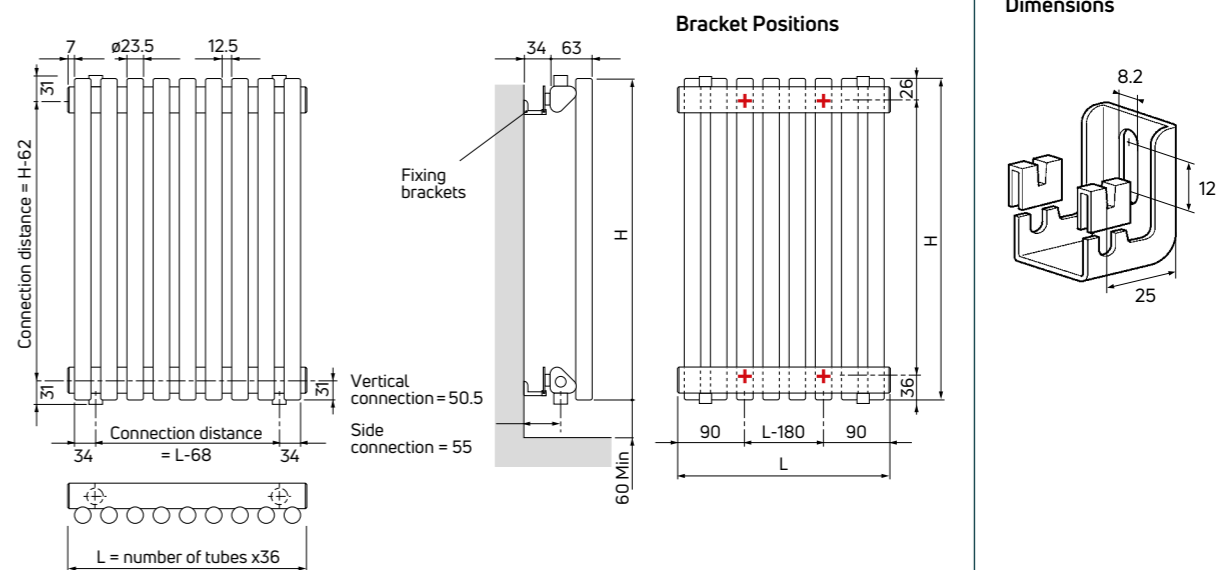

Wall Bracket Dimensions

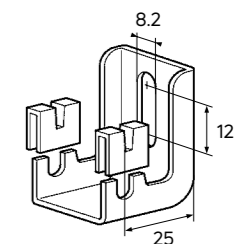

NB: All measurements are nominal.

Heat outputs

OPUS vertical

Order Code	Nominal Height (H) (mm)	Nominal Length (L) (mm)	No. of Tubes	Heat Outputs @ ΔT 50°C		Heat Outputs @ ΔT 30°C		n-Coefficients
				Watts	Btu/h	Watts	Btu/h	
MEZV1*	2000	324	9	803	2740	413	1409	1.304
MEZV2*	2000	468	13	1160	3958	596	2034	1.304
MEZV3*	2000	612	17	1516	5173	779	2658	1.304
MEZV4*	2000	756	21	1873	6391	1146	3910	1.304

OPUS horizontal

MEZH1*	468	600	13	403	1375	212	723	1.258
MEZH2*	612	600	17	516	1761	271	925	1.262
MEZH3*	468	1000	13	672	2293	353	1204	1.258
MEZH4*	612	1000	17	860	2934	451	1539	1.262

*Non-stock - made to order only.



Towel warmers

MYSON has over 60 years of manufacturing expertise. We have applied our knowledge and experience to create a range of stylish yet practical towel warmers. Our extensive range covers all tastes and aspirations and includes functional ladder rails, striking contemporary designs and elegant traditional styles. Popular products, such as AVONMORE, are ideal for domestic and commercial projects alike, whilst combination products such as DEE, combine the benefits of a radiator and a towel warmer.

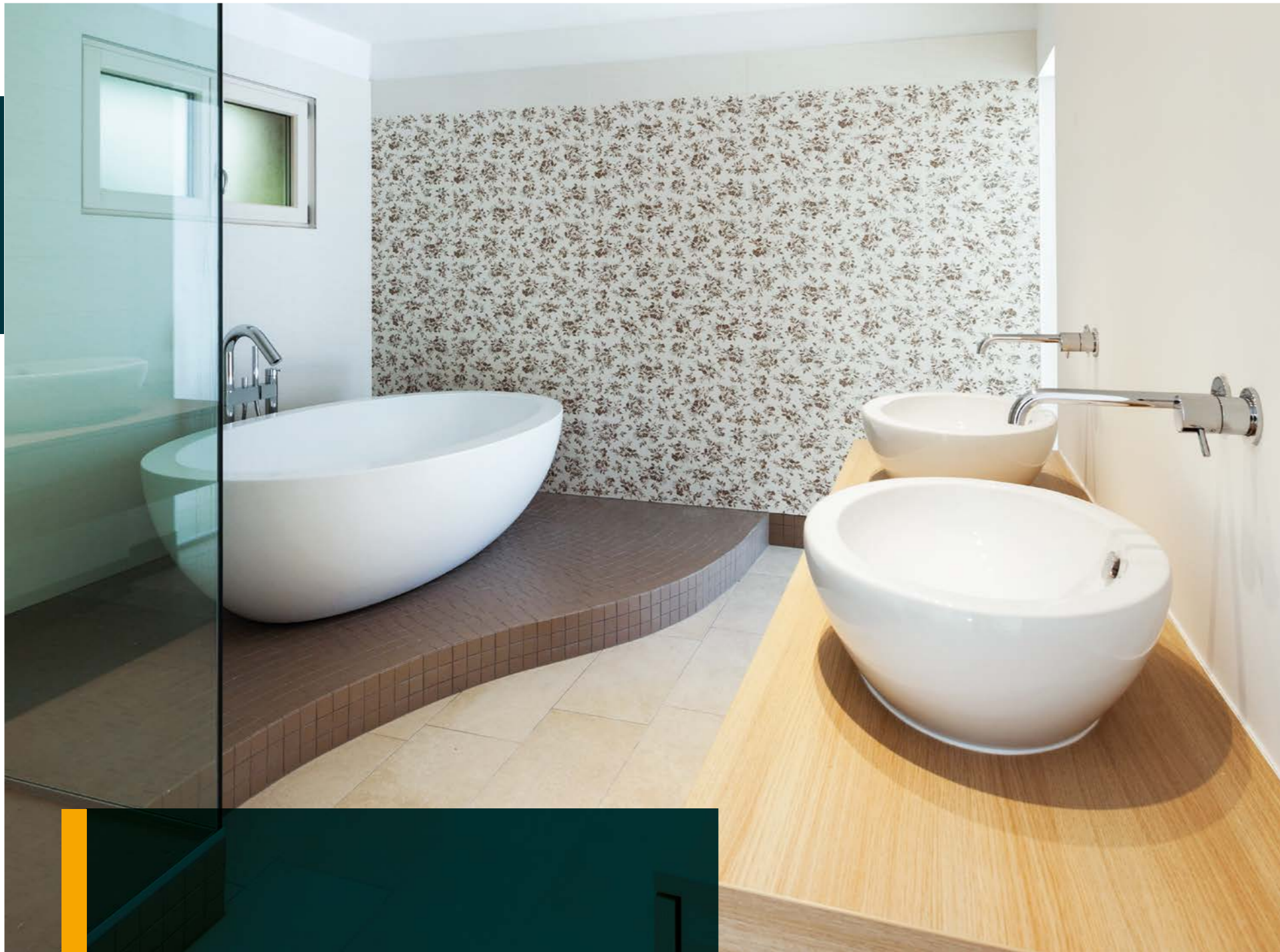

MYSON has a range of contemporary towel warmers that will add style, vibrancy and a bit of a wow factor to your bathroom. Our products have been expertly designed to look great, as well as serve as highly functional heat emitters. Our range is extremely diverse, from intricate masterpieces to stunningly simple designs, we're confident there is something for everyone. Most of our products come in a choice of finish, and several ranges are available in selected RAL colours, special textured, metallic and shimmer metallic finishes.

- Our contemporary collection is so versatile there is something to suit any bathroom
- Products like TOPAZ, FATALA and KASAI can be used as bathroom radiators to warm towels or to add style to a living room or bedroom
- We also have a range of contemporary electric towel warmers, see pages 216 - 221 for details

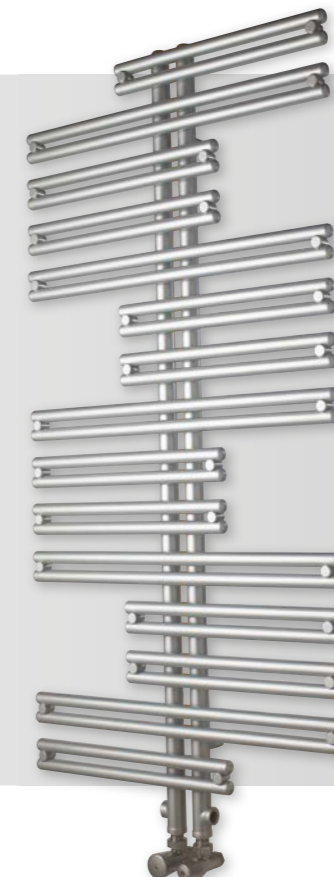

**CONTEMPORARY
TOWEL WARMERS**



NEW!

TOPAZ

The new double TOPAZ bathroom radiator from MYSON provides excellent heat output, thanks to its generous tubular water channels. It is the perfect specification towel radiator for low temperature heating systems.

TOPAZ is available in a wide choice of sizes, finished in White, Anthracite, Silver or Matt Black.

The contemporary and practical range will add style, vibrancy and a bit of wow to any bathroom.

Choose from a range of decorative valves to complement TOPAZ.



RAL 7016 Anthracite

Dimensions

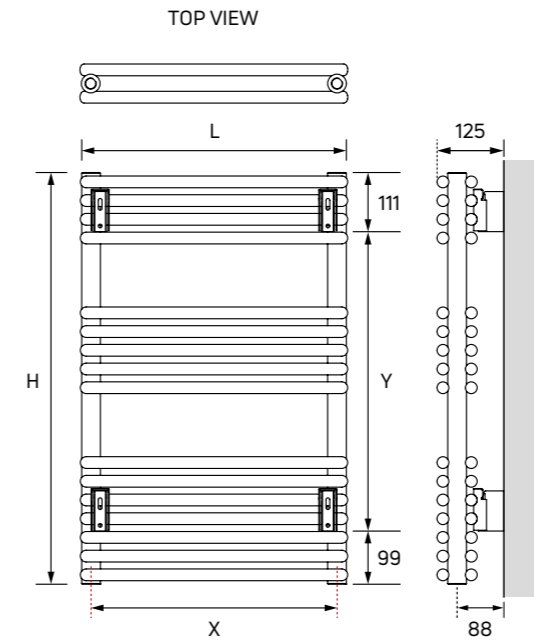

L (mm)	X (mm)	H (mm)	Y (mm)
400	360	770	560
500	460	1190	980
600	560	1785	1575

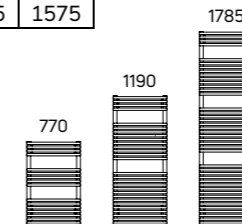

Weights, water contents & n-coefficients

Model (H/L)	Weight (kg)	Water Content (L)	n-Coefficient
770/400	14.00	5.10	1.2120
770/500	15.64	6.32	1.2104
770/600	18.24	7.53	1.2093
1190/400	21.00	7.55	1.2388
1190/500	23.56	8.99	1.2302
1190/600	27.48	10.44	1.2245
1785/400	29.80	11.60	1.2767
1785/500	35.83	15.57	1.2582
1785/600	41.86	19.54	1.2461

Technical information & heat outputs

Order Code (Type - Double)				Nominal Height (H) (mm)	Nominal Length (L) (mm)	Heat Outputs @ ΔT 50°C		Heat Outputs @ ΔT 30°C	
White	Anthracite	Matt Black	Silver			Watts	Btu/h	Watts	Btu/h
TPZD770400	TPZD7704007016	TPZD7704009005	TPZD770400SILV	770	400	513	1750	276	942
TPZD770500	TPZD7705007016	TPZD7705009005	TPZD770500SILV	770	500	639	2180	344	1174
TPZD770600	TPZD7706007016	TPZD7706009005	TPZD770600SILV	770	600	766	2614	413	1409
TPZD1190400	TPZD11904007016	TPZD11904009005	TPZD1190400SILV	1190	400	740	2525	393	1341
TPZD1190500	TPZD11905007016	TPZD11905009005	TPZD1190500SILV	1190	500	920	3139	490	1672
TPZD1190600	TPZD11906007016	TPZD11906009005	TPZD1190600SILV	1190	600	1099	3750	588	2006
TPZD1785400	TPZD17854007016	TPZD17854009005	TPZD1785400SILV	1785	400	1097	3743	571	1948
TPZD1785500	TPZD17855007016	TPZD17855009005	TPZD1785500SILV	1785	500	1340	4572	705	2405
TPZD1785600	TPZD17856007016	TPZD17856009005	TPZD1785600SILV	1785	600	1584	5405	838	2859

General specification

- CERTIFICATION**
Manufactured and tested to BS EN 442 & EN 442. Carries the CE & UKCA Mark. Produced under a quality management system - ISO 9001:2015, environmental management system - ISO 14001:2015 and Occupational health and safety management system - OHSAS 18001.
- CONNECTIONS**
2 x 1/2" BSP as standard.
- AIR VENTS**
Integrated, bottom-opposite-end connection.
- OPERATING PRESSURES**
Tested to a pressure of 5.4 bar. Working pressure of up to 4 bar.
- OPERATING TEMPERATURE**
Maximum hot water temperature 100°C.
- GUARANTEE**
10 year guarantee from date of purchase against manufacturing defects.
- COLOUR**
Available in White (RAL 9016), Anthracite (RAL 7016), Matt Black (RAL 9005) or Silver. Other colours available to order.
- DELIVERY**
5 - 7 working days. Made to order colours: 4 - 6 weeks.
- VALVES**
A range of decorative valves are available, see page 234.
- MATERIAL**
Manufactured from steel.
- SYSTEM**
2 pipe pumped indirect domestic and commercial heating applications.

For more general information, please see page 264.

Available colours



Made to order colours

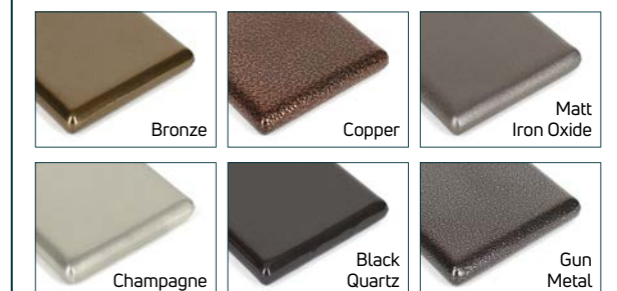

FATALA

Introduce contemporary elegance into your home with FATALA. Its attractive yet simple asymmetric design is both stylish and practical and will add a fresh modern look to a bathroom or living room. It's available in white or your choice of RAL colour as well as our special textured, metallic or shimmer metallic finishes.



General specification

- CERTIFICATION**
Manufactured and tested to BS EN 442 & EN 442. Carries the CE & UKCA Mark. Produced under a quality management system - ISO 9001:2015, environmental management system - ISO 14001:2015 and Occupational health and safety management system - OHSAS 18001.
- ACCESSORIES**
Please see page 140.
- SYSTEM**
2 pipe pumped indirect domestic and commercial heating applications.
- CONNECTIONS**
2 x 1/2" BSP as standard.
- AIR VENTS**
Included in the packaging.
- OPERATING PRESSURES**
Tested to a pressure of 13 bar. Working pressure of up to 10 bar.
- GUARANTEE**
10 year guarantee from date of purchase against manufacturing defects.
- COLOUR**
Finished in white (RAL 9016) or selected RAL, textured, metallic or shimmer metallic colours. Please see page 266.
- DELIVERY**
Non-stocked item: 4 - 6 weeks.
- MATERIAL**
Manufactured from steel.

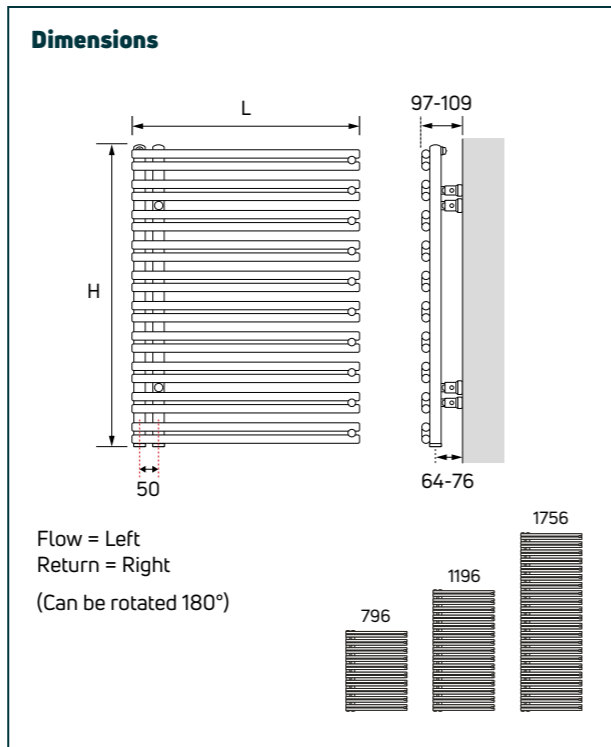

For more general information, please see page 264.

Weights, water contents & n-coefficients

Model	Weight (kg)	Water Content (l)	n-Coefficient
MAE1	8.90	3.80	1.189
MAE2	13.30	5.90	1.202
MAE3	19.50	8.00	1.241

Technical information & heat outputs

Order Code	Nominal Height (H) (mm)	Nominal Length (L) (mm)	Heat Outputs @ ΔT 50°C		Heat Outputs @ ΔT 30°C	
			Watts	Btu/h	Watts	Btu/h
MAE1*	796	500	446	1522	243	829
MAE2*	1196	500	650	2218	352	1201
MAE3*	1756	500	897	3061	476	1624

*Non-stock - made to order only.

INTERLUDE

INTERLUDE is a simple and elegant flat tube radiator. It is manufactured from quality steel and has a sleek and streamlined appearance. It is both practical and attractive and is available in selected RAL, metallic or special metallic finishes.



RAL 9016
Traffic White

General specification

- CERTIFICATION**
Manufactured and tested to BS EN 442 & EN 442. Carries the CE & UKCA Mark. Produced under a quality management system - ISO 9001:2015, environmental management system - ISO 14001:2015 and Occupational health and safety management system - OHSAS 18001.
- CONNECTIONS**
2 x 1/2" BSP as standard.
- AIR VENTS**
Included in the packaging.
- OPERATING PRESSURES**
Tested to a pressure of 5.2 bar. Working pressure of up to 4 bar.
- DUAL FUEL**
ECO450 dual fuel heater kit available for INT2 & INT3 only. Please see page 140.
- GUARANTEE**
10 year guarantee from date of purchase against manufacturing defects.
- COLOUR**
Finished in white (RAL 9016) or selected RAL, textured, metallic or shimmer metallic colours. Please see page 266.
- DELIVERY**
Non-stocked item: 4 - 6 weeks.
- MATERIAL**
Manufactured from steel.
- SYSTEM**
2 pipe pumped indirect domestic and commercial heating applications.

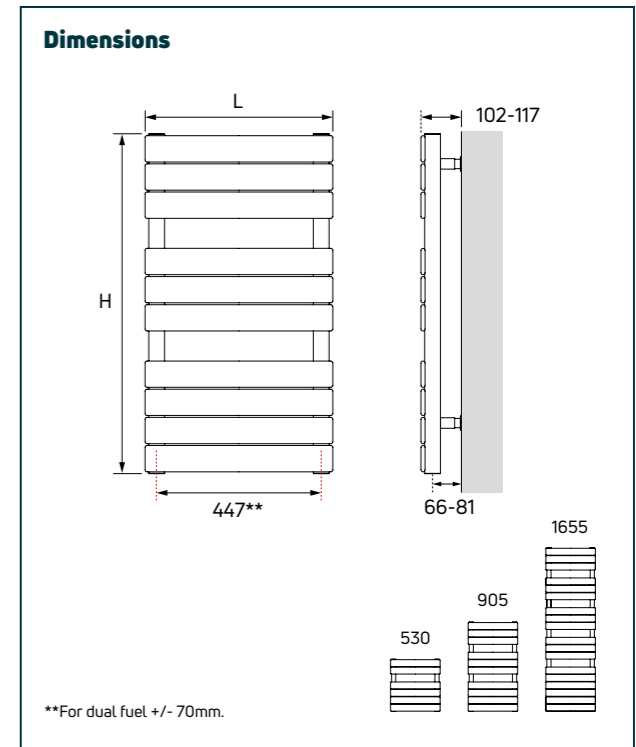

For more general information, please see page 264.

Weights, water contents & n-coefficients

Model	Weight (kg)	Water Content (l)	n-Coefficient
INT1	9.31	2.9	1.190
INT2	13.68	4.8	1.205
INT3	19.86	8.6	1.227

Technical information & heat outputs

Order Code	Nominal Height (H) (mm)	Nominal Length (L) (mm)	Heat Outputs @ ΔT 50°C		Heat Outputs @ ΔT 30°C		Dual Fuel Rating
			Watts	Btu/h	Watts	Btu/h	Watts
INT1*	530	500	295	1007	161	549	-
INT2*	905	500	470	1604	254	867	450
INT3*	1655	500	817	2788	435	1484	450

*Non-stock - made to order only.



KASAI

A striking and highly individual round tube radiator, KASAI demands to be noticed. It is a versatile choice and will make a strong addition to a bathroom or living space. It is available in selected RAL or metallic colour finishes to ensure that, whatever your décor, the KASAI will enhance your home.



RAL 9006
White Aluminium

Dimensions

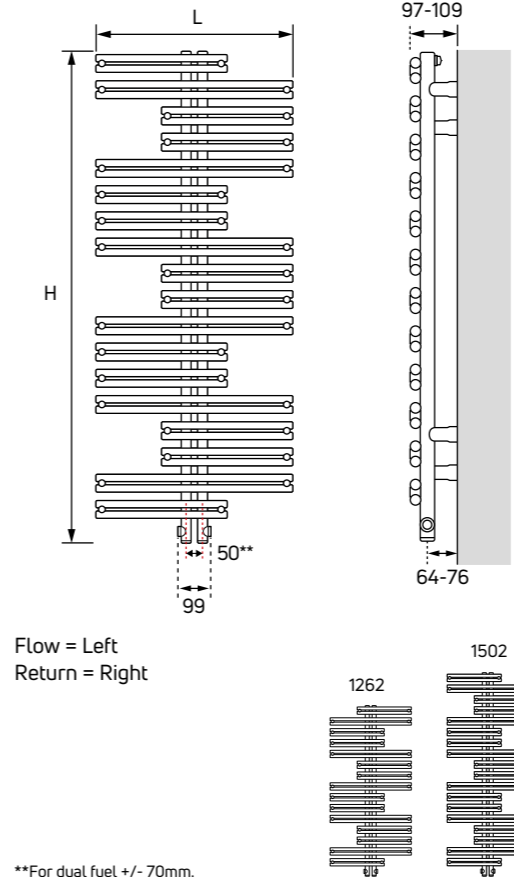

Flow = Left
Return = Right

**For dual fuel +/- 70mm.

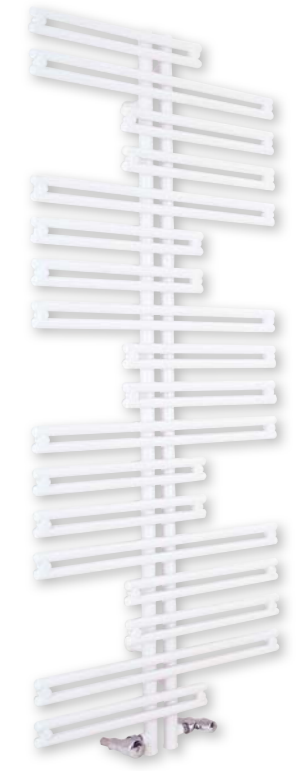

RAL 9016
Traffic White

Weights, water contents & n-coefficients

Model	Weight (kg)	Water Content (l)	n-Coefficient
CAP1	13.30	5.30	1.253
CAP2	16.00	6.10	1.247

General specification

- CERTIFICATION**
Manufactured and tested to BS EN 442 & EN 442. Carries the CE & UKCA Mark. Produced under a quality management system - ISO 9001:2015, environmental management system - ISO 14001:2015 and Occupational health and safety management system - OHSAS 18001.
- GUARANTEE**
10 year guarantee from date of purchase against manufacturing defects.
- COLOUR**
Finished in white (RAL 9016) or selected RAL, textured, metallic or shimmer metallic colours. Please see page 266.
- MATERIAL**
Manufactured from steel.
- ACCESSORIES**
Please see page 140.
- SYSTEM**
2 pipe pumped indirect domestic and commercial heating applications.
- CONNECTIONS**
4 x 1/2" BSP as standard - side or bottom connection possibilities.
- AIR VENTS**
Included in the packaging.
- OPERATING PRESSURES**
Tested to a pressure of 13 bar. Working pressure of up to 10 bar.
- DUAL FUEL**
ECO450 dual fuel heater kit available. Please see page 140.
- DELIVERY**
Non-stocked item: 4 - 6 weeks.

For more general information, please see page 264.

Technical information & heat outputs

Order Code	Nominal Height (H) (mm)	Nominal Length (L) (mm)	Heat Outputs @ ΔT 50°C		Heat Outputs @ ΔT 30°C		Dual Fuel Rating
			Watts	Btu/h	Watts	Btu/h	
CAP1*	1262	600	613	2092	323	1102	450
CAP2*	1502	600	724	2470	383	1307	450

*Non-stock - made to order only.

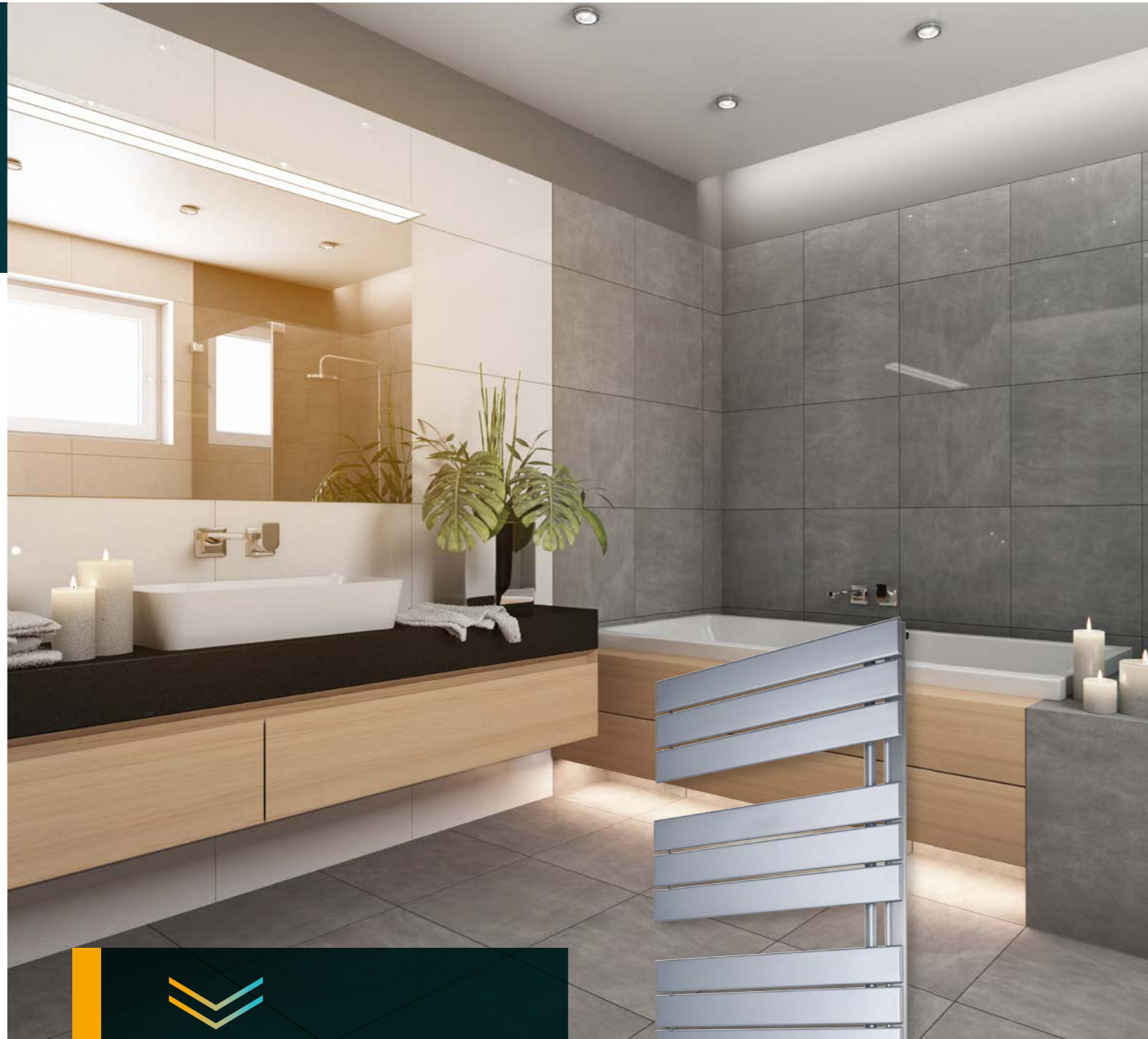

MARANO

MARANO has an attractive asymmetric design that uses blocks and spaces to create a distinctive appearance. The large flat tubes are both stylish and practical and, with left or right hand side mounting options, it offers flexibility in any project. MARANO is available in selected RAL, metallic or special metallic finishes.



RAL 9006
White Aluminium

Dimensions

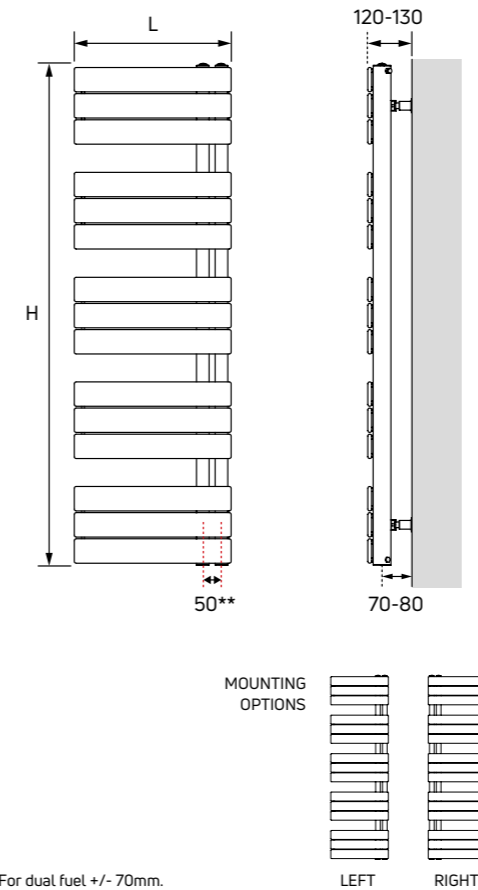

**For dual fuel +/- 70mm.

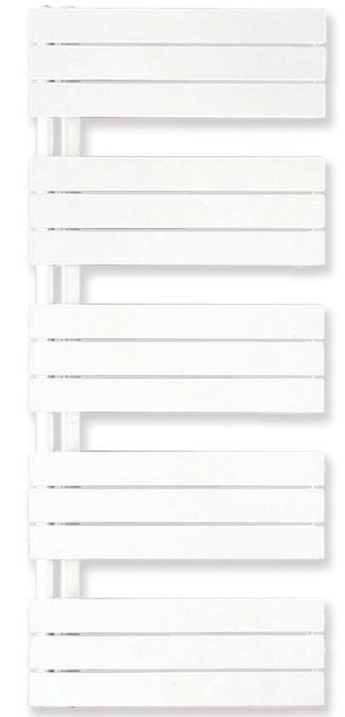

RAL 9016
Traffic White

Weights, water contents & n-coefficients

Model	Weight (kg)	Water Content (l)	n-Coefficient
CH02	21.28	8.5	1.272

General specification

- CERTIFICATION**
Manufactured and tested to BS EN 442 & EN 442. Carries the CE & UKCA Mark. Produced under a quality management system - ISO 9001:2015, environmental management system - ISO 14001:2015 and Occupational health and safety management system - OHSAS 18001.
- GUARANTEE**
10 year guarantee from date of purchase against manufacturing defects.
- COLOUR**
Finished in white (RAL 9016) or selected RAL, textured, metallic or shimmer metallic colours. Please see page 266.
- MATERIAL**
Manufactured from steel.
- SYSTEM**
2 pipe pumped indirect domestic and commercial heating applications.
- CONNECTIONS**
2 x 1/2" BSP as standard.
- AIR VENTS**
Integrated.
- OPERATING PRESSURES**
Tested to a pressure of 5.2 bar. Working pressure of up to 4 bar.
- DUAL FUEL**
ECO450 dual fuel heater kit available. Please see page 140.
- DELIVERY**
Non-stocked item: 4 - 6 weeks.

For more general information, please see page 264.

Technical information & heat outputs

Order Code	Nominal Height (H) (mm)	Nominal Length (L) (mm)	Heat Outputs @ ΔT 50°C		Heat Outputs @ ΔT 30°C		Dual Fuel Rating (Watts)
			Watts	Btu/h	Watts	Btu/h	
CH02*	1430	600	855	2917	446	1522	450

*Non-stock - made to order only.



MERSEY

MERSEY is an extremely functional radiator. It combines all the advantages of a PREMIER HE radiator and towel warmer for a truly practical design. It is manufactured from high quality brass with an attractive polished chrome plated finish. MERSEY is ideal for use not just in bathrooms but also kitchens, cloakrooms and other small areas.



OUSE

OUSE is a highly practical combination radiator. At its centre is a PREMIER HE radiator that produces high heat outputs. This is surrounded by a functional round tube frame that is manufactured from high quality brass and has an attractive polished chrome plated finish.



General specification

- CERTIFICATION**
Manufactured and tested to BS EN 442 & EN 442. Carries the CE & UKCA Mark. Produced under a quality management system - ISO 9001:2015, environmental management system - ISO 14001:2015 and Occupational health and safety management system - OHSAS 18001.
- SYSTEM**
2 pipe pumped indirect domestic and commercial heating applications.
- CONNECTIONS**
2 x 1/2" BSP as standard.
- AIR VENTS**
Integrated.
- OPERATING PRESSURES**
Tested to a pressure of 6.9 bar. Working pressure of up to 5.3 bar.
- DELIVERY**
Non-stocked item: 8 - 10 weeks.
- GUARANTEE**
10 year guarantee from date of purchase against manufacturing defects.
- COLOUR**
Frame finished in chrome. Radiator in white (RAL 9016).
- MATERIAL**
Frame manufactured from brass. Radiator manufactured from steel.

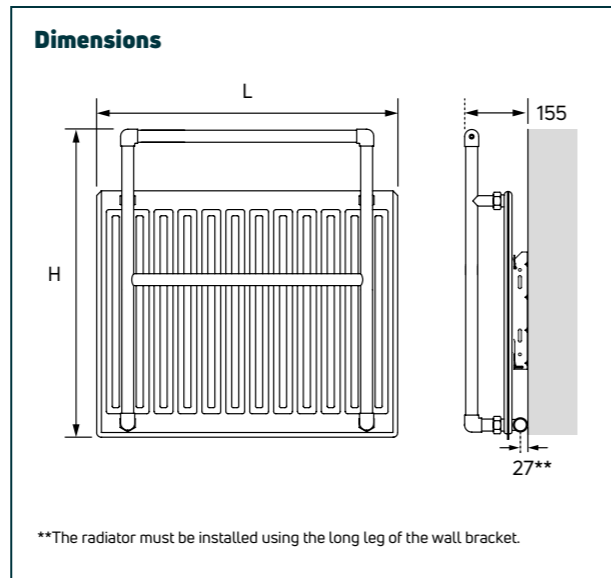

For more general information, please see page 264.

Weights

Model	Weight (kg)
MTR2	11.10
MTR4	15.10

Technical information & heat outputs

Order Code	Nominal Height (H) (mm)	Nominal Length (L) (mm)	Heat Outputs @ ΔT 50°C		Heat Outputs @ ΔT 30°C	
			Watts	Btu/h	Watts	Btu/h
MTR2*	655	640	385†	1314†	208†	709†
MTR4*	809	745	564†	192†	295†	1007†

*Non-stock - made to order only. †Outputs NPD, see page 265.

General specification

- CERTIFICATION**
Manufactured and tested to BS EN 442 & EN 442. Carries the CE & UKCA Mark. Produced under a quality management system - ISO 9001:2015, environmental management system - ISO 14001:2015 and Occupational health and safety management system - OHSAS 18001.
- SYSTEM**
2 pipe pumped indirect domestic and commercial heating applications.
- CONNECTIONS**
2 x 1/2" BSP as standard.
- AIR VENTS**
Integrated.
- OPERATING PRESSURES**
Tested to a pressure of 6.9 bar. Working pressure of up to 5.3 bar.
- DELIVERY**
Non-stocked item: 8 - 10 weeks.
- GUARANTEE**
10 year guarantee from date of purchase against manufacturing defects.
- COLOUR**
Frame finished in chrome. Radiator in white (RAL 9016).
- MATERIAL**
Frame manufactured from brass. Radiator manufactured from steel.
- ACCESSORIES**
Sleeving kit available. Please see page 140.

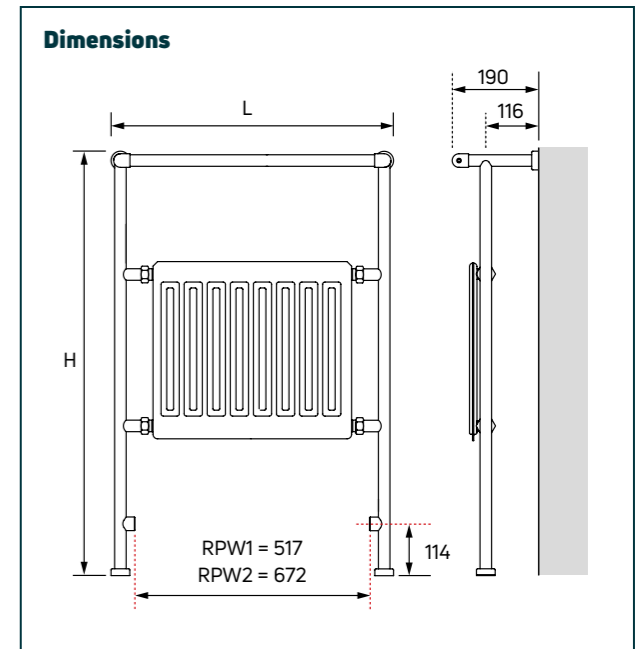

For more general information, please see page 264.

Weights & n-coefficients

Model	Weight (kg)	n-Coefficient
RPW1	10.90	1.212
RPW2	12.40	1.212

Technical information & heat outputs

Order Code	Nominal Height (H) (mm)	Nominal Length (L) (mm)	Heat Outputs @ ΔT 50°C		Heat Outputs @ ΔT 30°C	
			Watts	Btu/h	Watts	Btu/h
RPW1*	934	622	290	989	156	532
RPW2*	934	777	359	1225	193	659

*Non-stock - made to order only.

SOKOTO

SOKOTO is a stylish and distinctive combination radiator. It is highly practical, with a flat tube DÉCOR radiator at its centre, giving it not only high heat outputs, but an attractive appearance. The outer rail is manufactured from high quality brass with an attractive polished chrome plated finish which gives it a truly modern feel.



STOUR

STOUR is a beautifully simple frame and rail design that will look classy and elegant in any bathroom. Its round tubes are manufactured from quality brass with a highly polished chrome finish.



General specification

- CERTIFICATION**
Manufactured and tested to BS EN 442 & EN 442. Carries the CE & UKCA Mark. Produced under a quality management system - ISO 9001:2015, environmental management system - ISO 14001:2015 and Occupational health and safety management system - OHSAS 18001.
- ACCESSORIES**
Sleeving kit available. Please see page 140.
- SYSTEM**
2 pipe pumped indirect domestic and commercial heating applications.
- CONNECTIONS**
2 x 1/2" BSP as standard.
- AIR VENTS**
Integrated.
- OPERATING PRESSURES**
Tested to a pressure of 6.9 bar. Working pressure of up to 5.3 bar.
- DELIVERY**
Non-stocked item: 8 - 10 weeks.
- GUARANTEE**
10 year guarantee from date of purchase against manufacturing defects.
- COLOUR**
Frame finished in chrome. Radiator in white (RAL 9016).
- MATERIAL**
Frame manufactured from brass. Radiator manufactured from steel.

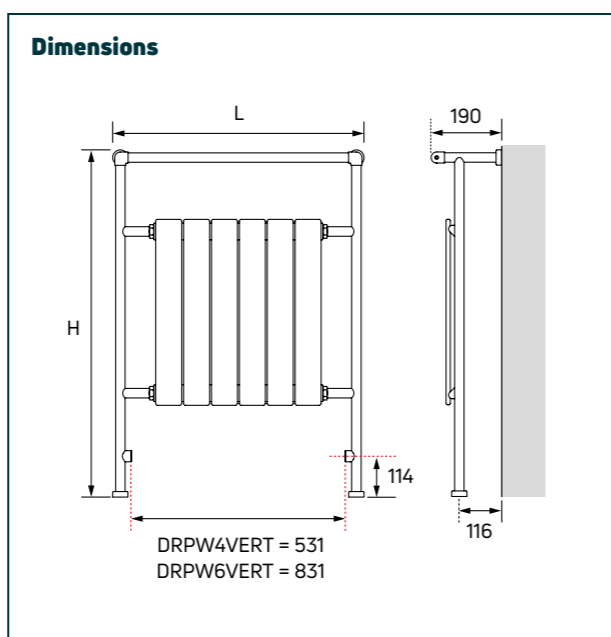

For more general information, please see page 264.

Weights & n-coefficients

Model	Weight (kg)	n-Coefficient
DRPW4VERT	13.70	1.224
DRPW6VERT	18.80	1.224

Technical information & heat outputs

Order Code	Nominal Height (H) (mm)	Nominal Length (L) (mm)	Heat Outputs @ ΔT 50°C		Heat Outputs @ ΔT 30°C	
			Watts	Btu/h	Watts	Btu/h
DRPW4VERT*	934	636	387	1320	207	706
DRPW6VERT*	934	936	559	1907	299	1020

*Non-stock - made to order only.

General specification

- CERTIFICATION**
Manufactured and tested to BS EN 442 & EN 442. Carries the CE & UKCA Mark. Produced under a quality management system - ISO 9001:2015, environmental management system - ISO 14001:2015 and Occupational health and safety management system - OHSAS 18001.
- SYSTEM (DIRECT)**
Suitable for direct systems. Please refer to page 265 for information on dezincification.
- CONNECTIONS**
2 x 1/2" BSP as standard.
- AIR VENTS**
Integrated.
- OPERATING PRESSURES**
Tested to a pressure of 6.9 bar. Working pressure of up to 5.3 bar.
- DUAL FUEL**
PTC dual fuel heater kit options available. Please see table below or page 140.
- APM TECHNOLOGY**
PTC heater kit comes with APM technology. Please see page 265.
- DELIVERY**
2 - 5 working days. Non-stocked items: 8 - 10 weeks.
- GUARANTEE**
10 year guarantee from date of purchase against manufacturing defects.
- COLOUR**
Finished in chrome.
- MATERIAL**
Manufactured from brass.
- SYSTEM (INDIRECT)**
2 pipe pumped indirect domestic and commercial heating applications.

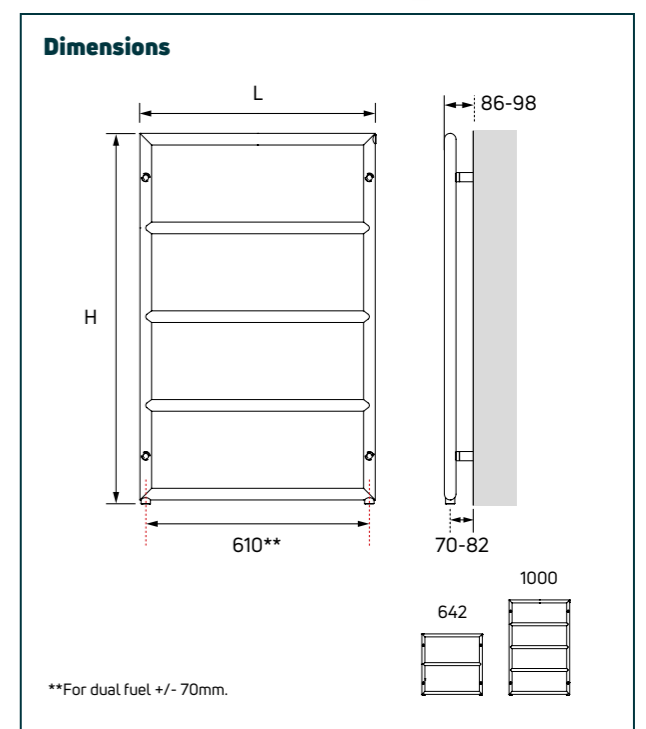

For more general information, please see page 264.

Dual fuel heater kits

Model	Dual Fuel Order Code
BEA1	PTC75
BEA6	PTC150

Weights

Model	Weight (kg)
BEA1	5.20
BEA6	7.60

Technical information & heat outputs

Order Code	Nominal Height (H) (mm)	Nominal Length (L) (mm)	Heat Outputs @ ΔT 50°C		Heat Outputs @ ΔT 30°C		Dual Fuel Rating
			Watts	Btu/h	Watts	Btu/h	
BEA1*	642	642	193†	659†	104†	356†	75
BEA6	1000	642	274†	935†	148†	505†	150

*Non-stock - made to order only. †Outputs NPD, see page 265.



MYSON has a range of traditional towel warmers that will give your bathroom a classic, vintage and elegant feel. From simple rails to more elaborate designs, there is something for everyone. Our traditional range is manufactured from the highest quality brass and all come with a beautiful, highly polished chrome finish that will add a touch of class to any bathroom. We also offer a range of accessories that complement the range and add the finishing touch, see page 140.

- Our traditional collection offers varied designs and includes both wall and floor mounted models
- There are combination products, such as DEE, that offer high heat outputs as well as traditional design
- Wow factor products, such as BUTTERMERE and AWE will stand out in any traditional bathroom design



BUTTERMERE



ULLSWATER

TRADITIONAL TOWEL WARMERS

AWE

AWE is an attractive and distinguished design. It is a floor standing towel warmer that will make a very stylish addition to any bathroom. It is manufactured from quality brass with a highly polished chrome plated finish which will create a focal point in any bathroom.



BUTTERMERE

BUTTERMERE is a classic floor standing design that is guaranteed to add a strong, traditional feel to a bathroom. Its double-sided, curved shape and timeless look is both stylish and practical. It is manufactured from quality brass with a highly polished chrome plated finish which will create a focal point in any bathroom.

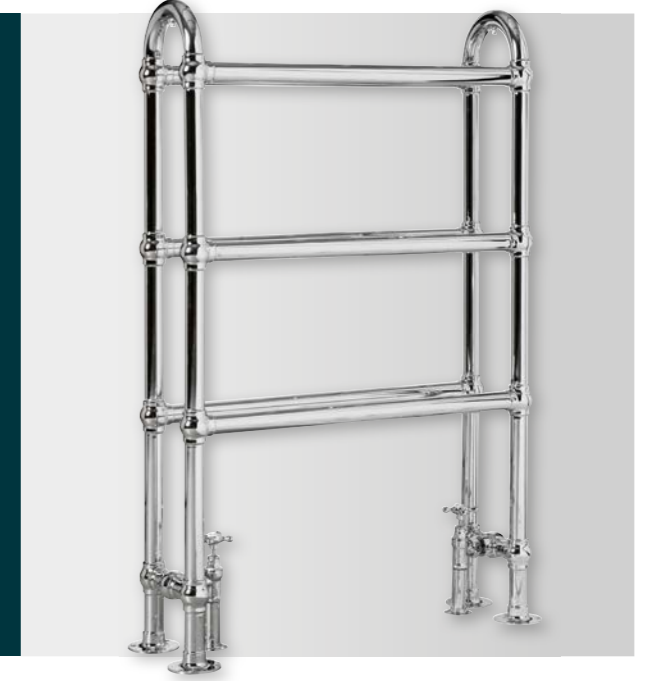

General specification

- CERTIFICATION**
Manufactured and tested to BS EN 442 & EN 442. Carries the CE & UKCA Mark. Produced under a quality management system - ISO 9001:2015, environmental management system - ISO 14001:2015 and Occupational health and safety management system - OHSAS 18001.
- AIR VENTS**
Integrated.
- OPERATING PRESSURES**
Tested to a pressure of 6.9 bar. Working pressure of up to 5.3 bar.
- DUAL FUEL**
PTC200 dual fuel heater kit available. Please see page 140.
- APM[®] TECHNOLOGY**
PTC heater kit comes with APM[®] technology. Please see page 265.
- DELIVERY**
Non-stocked item: 8 - 10 weeks.
- VALVES**
Please see page 234.
- GUARANTEE**
10 year guarantee from date of purchase against manufacturing defects.
- COLOUR**
Finished in chrome.
- MATERIAL**
Manufactured from brass.
- ACCESSORIES**
Please see page 140.
- SYSTEM (INDIRECT)**
2 pipe pumped indirect domestic and commercial heating applications.
- SYSTEM (DIRECT)**
Suitable for direct systems. Please refer to page 265 for information on dezincification.

For more general information, please see page 264.

Dimensions

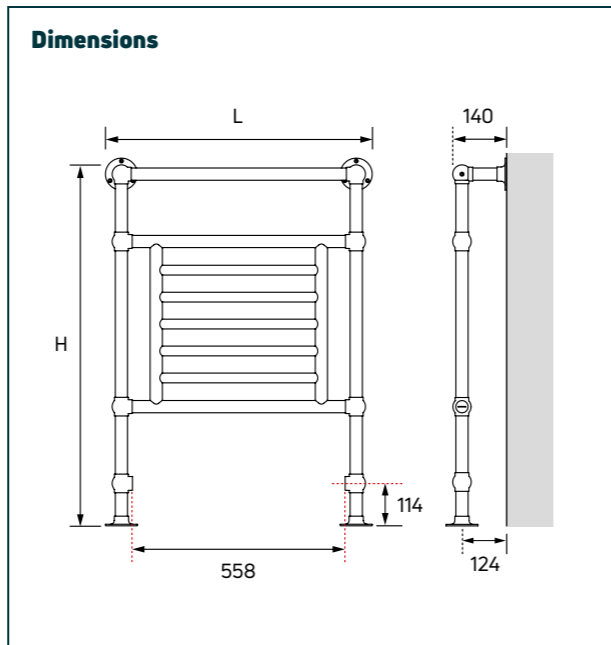

Weight & n-coefficient

Model	Weight (kg)	n-Coefficient
B27/1	10.50	1.240

Technical information & heat outputs

Order Code	Nominal Height (H) (mm)	Nominal Length (L) (mm)	Heat Outputs @ ΔT 50°C		Heat Outputs @ ΔT 30°C		Dual Fuel Rating (Watts)
			Watts	Btu/h	Watts	Btu/h	
B27/1*	955	693	223	761	118	403	200

*Non-stock - made to order only.

General specification

- CERTIFICATION**
Manufactured and tested to BS EN 442 & EN 442. Carries the CE & UKCA Mark. Produced under a quality management system - ISO 9001:2015, environmental management system - ISO 14001:2015 and Occupational health and safety management system - OHSAS 18001.
- AIR VENTS**
Integrated.
- OPERATING PRESSURES**
Tested to a pressure of 6.9 bar. Working pressure of up to 5.3 bar.
- DELIVERY**
2 - 5 working days.
- VALVES**
Please see page 234.
- GUARANTEE**
10 year guarantee from date of purchase against manufacturing defects.
- COLOUR**
Finished in chrome.
- MATERIAL**
Manufactured from brass.
- ACCESSORIES**
Please see page 140.
- SYSTEM (INDIRECT)**
2 pipe pumped indirect domestic and commercial heating applications.
- SYSTEM (DIRECT)**
Suitable for direct systems. Please refer to page 265 for information on dezincification.
- AIR VENTS**
Integrated.
- OPERATING PRESSURES**
Tested to a pressure of 6.9 bar. Working pressure of up to 5.3 bar.
- DELIVERY**
2 - 5 working days.
- VALVES**
Please see page 234.

For more general information, please see page 264.

Dimensions

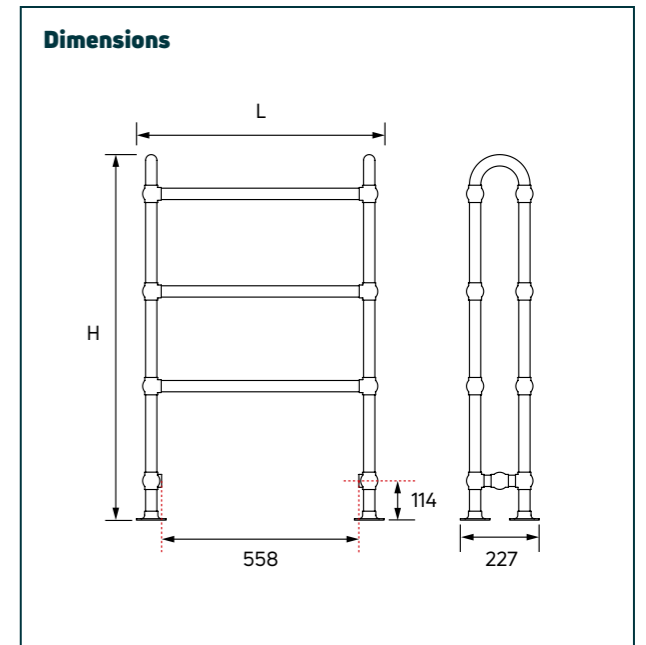

Weight & n-coefficient

Model	Weight (kg)	n-Coefficient
B30	15.10	1.190

Technical information & heat outputs

Order Code	Nominal Height (H) (mm)	Nominal Length (L) (mm)	Heat Outputs @ ΔT 50°C		Heat Outputs @ ΔT 30°C	
			Watts	Btu/h	Watts	Btu/h
B30	1026	693	325	1109	177	604

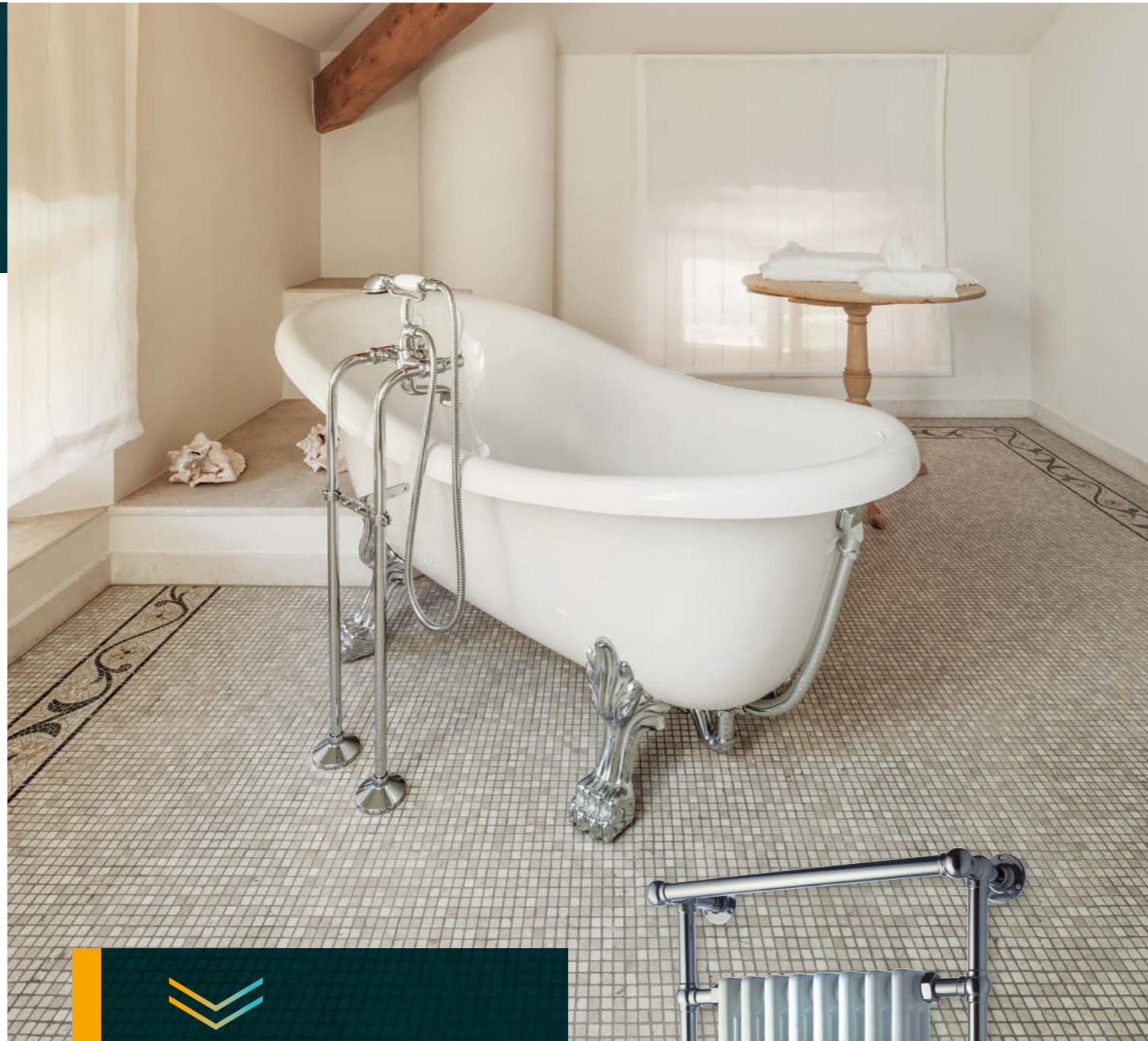

DEE is a high quality, floor standing combination radiator that will add a classic, vintage feel to your bathroom. With a beautiful COLUMN radiator nestled inbetween a traditional elegant chrome frame, this radiator offers you the best of both worlds.



Dimensions

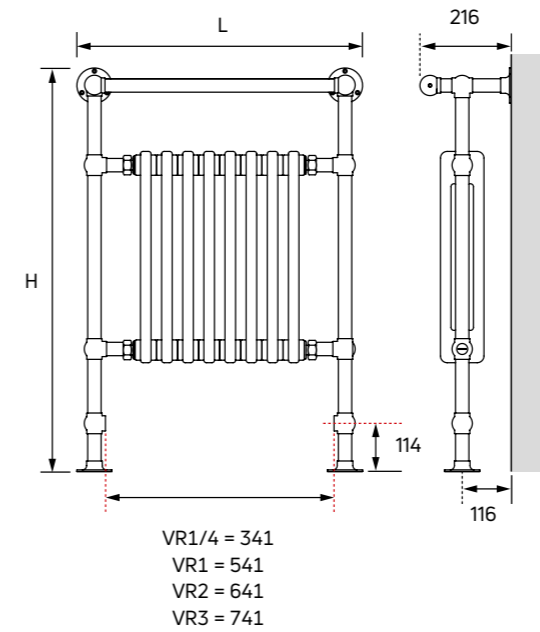

Weights & n-coefficients

Model	Weight (kg)	n-Coefficient
VR1/4	15.60	1.224
VR1	21.30	1.224
VR2	24.40	1.224
VR3	27.00	1.224

Dual fuel heater kits

Model	Dual Fuel Order Code
VR1/4	PTC300
VR1	PTC400
VR2/VR3	PTC500

General specification

- CERTIFICATION**
Manufactured and tested to BS EN 442 & EN 442. Carries the CE & UKCA Mark. Produced under a quality management system - ISO 9001:2015, environmental management system - ISO 14001:2015 and Occupational health and safety management system - OHSAS 18001.
- GUARANTEE**
10 year guarantee from date of purchase against manufacturing defects.
- COLOUR**
Frame finished in chrome. Radiator in white (RAL 9016).
- MATERIAL**
Frame manufactured from brass. Radiator manufactured from steel.
- ACCESSORIES**
Please see page 140.
- SYSTEM**
2 pipe pumped indirect domestic and commercial heating applications.
- CONNECTIONS**
2 x 1/2" BSP as standard.
- AIR VENTS**
Integrated.
- OPERATING PRESSURES**
Tested to a pressure of 9.6 bar. Working pressure of up to 7.4 bar.
- DUAL FUEL**
PTC dual fuel heater kit options available. Please see table above or page 140.
- APM[®] TECHNOLOGY**
PTC heater kit comes with APM[®] technology. Please see page 265.
- DELIVERY**
2 - 5 working days. Non-stocked items: 8 - 10 weeks.
- VALVES**
Please see page 234.

For more general information, please see page 264.

Technical information & heat outputs

Order Code	Nominal Height (H) (mm)	Nominal Length (L) (mm)	Heat Outputs @ ΔT 50°C		Heat Outputs @ ΔT 30°C		Dual Fuel Rating
			Watts	Btu/h	Watts	Btu/h	
VR1/4*	955	476	423	1443	226	771	300
VR1	955	676	602	2054	322	1099	400
VR2*	955	776	692	2361	370	1262	500
VR3*	955	876	783	2672	419	1430	500

*Non-stock - made to order only.

INN

INN is a simple but stylish floor standing design that will enhance any bathroom. It has a classic, minimalistic look that is also very practical, making it an ideal choice for creating an understated, traditional feel. It is manufactured from quality brass with a highly polished chrome finish.



SAXBY

SAXBY is a classic towel warmer design that is both simple and traditional. It is a practical and unobtrusive choice and will subtly enhance your bathroom with the benefit of both style and function. It is manufactured from quality brass and has a highly polished chrome plated finish.



General specification

- CERTIFICATION**
Manufactured and tested to BS EN 442 & EN 442. Carries the CE & UKCA Mark. Produced under a quality management system - ISO 9001:2015, environmental management system - ISO 14001:2015 and Occupational health and safety management system - OHSAS 18001.
- AIR VENTS**
Integrated.
- OPERATING PRESSURES**
Tested to a pressure of 6.9 bar. Working pressure of up to 5.3 bar.
- DUAL FUEL**
PTC100 dual fuel heater kit available. Please see page 140.
- GUARANTEE**
10 year guarantee from date of purchase against manufacturing defects.
- COLOUR**
Finished in chrome.
- MATERIAL**
Manufactured from brass.
- ACCESSORIES**
Please see page 140.
- SYSTEM (INDIRECT)**
2 pipe pumped indirect domestic and commercial heating applications.
- SYSTEM (DIRECT)**
Suitable for direct systems. Please refer to page 265 for information on dezincification.
- AIR VENTS**
Integrated.
- OPERATING PRESSURES**
Tested to a pressure of 6.9 bar. Working pressure of up to 5.3 bar.
- DUAL FUEL**
PTC100 dual fuel heater kit available. Please see page 140.
- GUARANTEE**
10 year guarantee from date of purchase against manufacturing defects.
- COLOUR**
Finished in chrome.
- MATERIAL**
Manufactured from brass.
- SYSTEM (INDIRECT)**
2 pipe pumped indirect domestic and commercial heating applications.
- SYSTEM (DIRECT)**
Suitable for direct systems. Please refer to page 265 for information on dezincification.

For more general information, please see page 264.

Dimensions

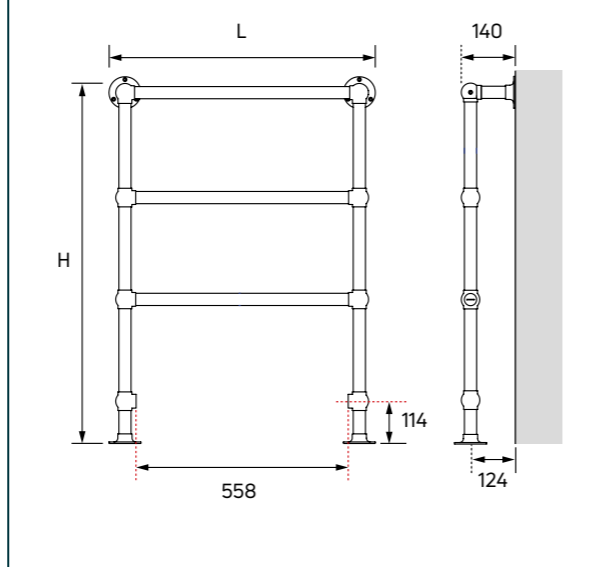

Weight

Model	Weight (kg)
B24/1	8.50

Technical information & heat outputs

Order Code	Nominal Height (H) (mm)	Nominal Length (L) (mm)	Heat Outputs @ ΔT 50°C		Heat Outputs @ ΔT 30°C		Dual Fuel Rating (Watts)
			Watts	Btu/h	Watts	Btu/h	
B24/1	955	693	146 [†]	498 [†]	79 [†]	269 [†]	100

[†]Outputs NPD, see page 265.

General specification

- CERTIFICATION**
Manufactured and tested to BS EN 442 & EN 442. Carries the CE & UKCA Mark. Produced under a quality management system - ISO 9001:2015, environmental management system - ISO 14001:2015 and Occupational health and safety management system - OHSAS 18001.
- AIR VENTS**
Integrated.
- OPERATING PRESSURES**
Tested to a pressure of 6.9 bar. Working pressure of up to 5.3 bar.
- DUAL FUEL**
PTC100 dual fuel heater kit available. Please see page 140.
- GUARANTEE**
10 year guarantee from date of purchase against manufacturing defects.
- COLOUR**
Finished in chrome.
- MATERIAL**
Manufactured from brass.
- SYSTEM (INDIRECT)**
2 pipe pumped indirect domestic and commercial heating applications.
- SYSTEM (DIRECT)**
Suitable for direct systems. Please refer to page 265 for information on dezincification.
- AIR VENTS**
Integrated.
- OPERATING PRESSURES**
Tested to a pressure of 6.9 bar. Working pressure of up to 5.3 bar.
- DUAL FUEL**
PTC100 dual fuel heater kit available. Please see page 140.
- GUARANTEE**
10 year guarantee from date of purchase against manufacturing defects.
- COLOUR**
Finished in chrome.
- MATERIAL**
Manufactured from brass.
- SYSTEM (INDIRECT)**
2 pipe pumped indirect domestic and commercial heating applications.
- SYSTEM (DIRECT)**
Suitable for direct systems. Please refer to page 265 for information on dezincification.

For more general information, please see page 264.

Dimensions

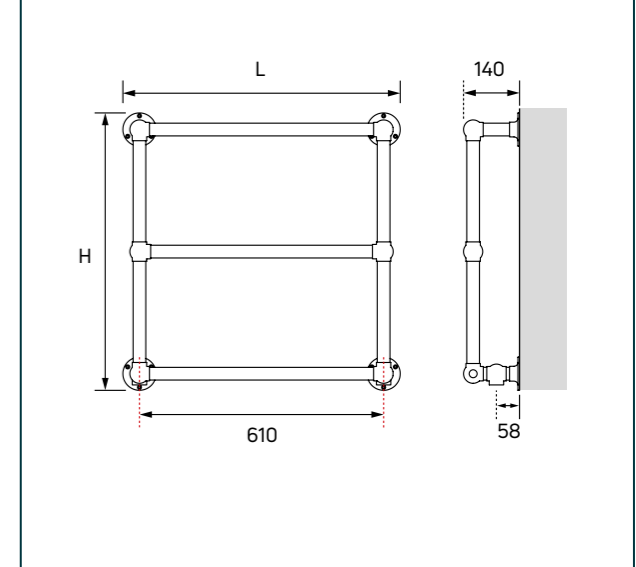

Weight

Model	Weight (kg)
B34/1	7.50

Technical information & heat outputs

Order Code	Nominal Height (H) (mm)	Nominal Length (L) (mm)	Heat Outputs @ ΔT 50°C		Heat Outputs @ ΔT 30°C		Dual Fuel Rating (Watts)
			Watts	Btu/h	Watts	Btu/h	
B34/1*	693	693	199 [†]	679 [†]	10 [†]	367 [†]	100

*Non-stock - made to order only. [†]Outputs NPD, see page 265.



THIRLMERE

THIRLMERE is an elegant, minimalist design that projects a classic and simple style. It makes a subtle but important addition to any bathroom - unobtrusively and quietly satisfying the need for both style and function. It is manufactured from quality brass and has a highly polished chrome plated finish.



General specification

- CERTIFICATION**
Manufactured and tested to BS EN 442 & EN 442. Carries the CE & UKCA Mark. Produced under a quality management system - ISO 9001:2015, environmental management system - ISO 14001:2015 and Occupational health and safety management system - OHSAS 18001.
 - GUARANTEE**
10 year guarantee from date of purchase against manufacturing defects.
 - COLOUR**
Finished in chrome.
 - MATERIAL**
Manufactured from brass.
 - SYSTEM (INDIRECT)**
2 pipe pumped indirect domestic and commercial heating applications.
 - SYSTEM (DIRECT)**
Suitable for direct systems. Please refer to page 265 for information on dezincification.
 - CONNECTIONS**
2 x 1/2" BSP as standard.
 - AIR VENTS**
Integrated.
 - OPERATING PRESSURES**
Tested to a pressure of 6.9 bar. Working pressure of up to 5.3 bar.
 - DUAL FUEL**
PTC150 dual fuel heater kit available. Please see page 140.
 - APM* TECHNOLOGY**
PTC heater kit comes with APM* technology. Please see page 265.
 - DELIVERY**
Non-stocked item: 8 - 10 weeks.
 - VALVES**
Please see page 234.
- For more general information, please see page 264.

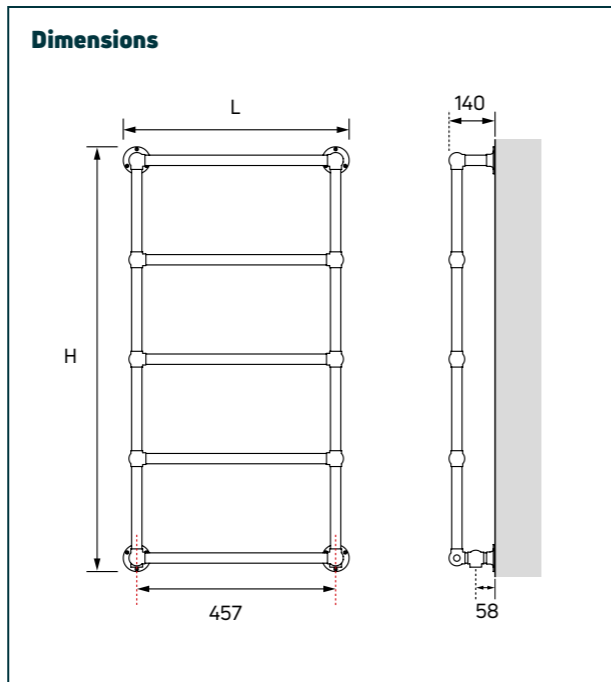

Weight

Model	Weight (kg)
B35/1	10.50

Technical information & heat outputs

Order Code	Nominal Height (H) (mm)	Nominal Length (L) (mm)	Heat Outputs @ ΔT 50°C		Heat Outputs @ ΔT 30°C		Dual Fuel Rating (Watts)
			Watts	Btu/h	Watts	Btu/h	
B35/1*	1303	540	226†	770†	122†	416†	150

*Non-stock - made to order only. †Outputs NPD, see page 265.



ULLSWATER

ULLSWATER adds a touch of traditional style for any bathroom. It has a timeless quality which exudes rustic charm and its simple, rectangular framed design can be enhanced with traditional look valves for a truly authentic feel. It is manufactured from quality brass and has a highly polished chrome plated finish.



General specification

- CERTIFICATION**
Manufactured and tested to BS EN 442 & EN 442. Carries the CE & UKCA Mark. Produced under a quality management system - ISO 9001:2015, environmental management system - ISO 14001:2015 and Occupational health and safety management system - OHSAS 18001.
 - GUARANTEE**
10 year guarantee from date of purchase against manufacturing defects.
 - COLOUR**
Finished in chrome.
 - MATERIAL**
Manufactured from brass.
 - SYSTEM (INDIRECT)**
2 pipe pumped indirect domestic and commercial heating applications.
 - SYSTEM (DIRECT)**
Suitable for direct systems. Please refer to page 265 for information on dezincification.
 - CONNECTIONS**
2 x 1/2" BSP as standard.
 - AIR VENTS**
Integrated.
 - OPERATING PRESSURES**
Tested to a pressure of 6.9 bar. Working pressure of up to 5.3 bar.
 - DUAL FUEL**
PTC300 dual fuel heater kit available. Please see page 140.
 - APM* TECHNOLOGY**
PTC heater kit comes with APM* technology. Please see page 265.
 - DELIVERY**
Non-stocked item: 8 - 10 weeks.
 - VALVES**
Please see page 234.
- For more general information, please see page 264.

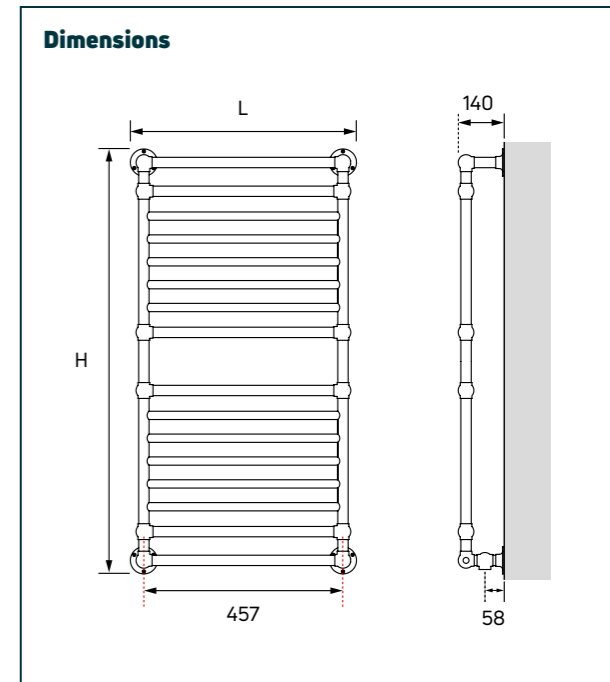

Weight & n-coefficient

Model	Weight (kg)	n-Coefficient
B36/1	14.40	1.218

Technical information & heat outputs

Order Code	Nominal Height (H) (mm)	Nominal Length (L) (mm)	Heat Outputs @ ΔT 50°C		Heat Outputs @ ΔT 30°C		Dual Fuel Rating (Watts)
			Watts	Btu/h	Watts	Btu/h	
B36/1*	1302	540	350	1194	188	641	300

*Non-stock - made to order only.



MYSON's years of manufacturing expertise has allowed us to develop products that not only look great, but are also highly functional items. Our multi-rail towel warmers are simple, elegant and practical and are designed to achieve the perfect combination of practical towel placement and stylish design. We offer a choice of finish, as selected ranges are available in white, or the more popular chrome finish, as well as straight and curved options. They are made from quality brass or steel and manufactured to the highest standards.

- Ladder rails have become a modern requirement for any bathroom, and we have an extensive range to suit every need
- The popular AVONMORE is the perfect specification towel rail. There's a large choice of sizes, a white or chrome finish and straight or curved options. It also offers excellent heat outputs
- For that extra special finish, we have a range of luxury towel rails in ANGARA, FERLO and LINDI

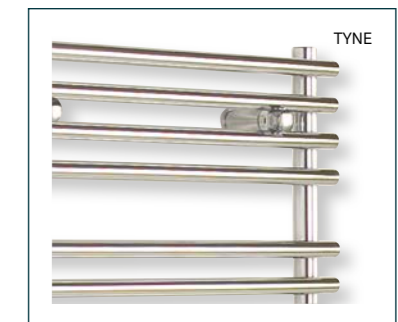

MULTI-RAIL TOWEL WARMERS



ELECTRIC MODEL AVAILABLE
Please see page 216

AVONMORE

AVONMORE is a classic multi-rail design that is available in a range of sizes, finishes, and straight or curved models. This makes it an extremely popular specification product for new build. It is highly functional for heating, with good outputs, and it has tube spacing for practical towel placement. With three different rail configurations, this is a flexible choice for any project.

Dimensions

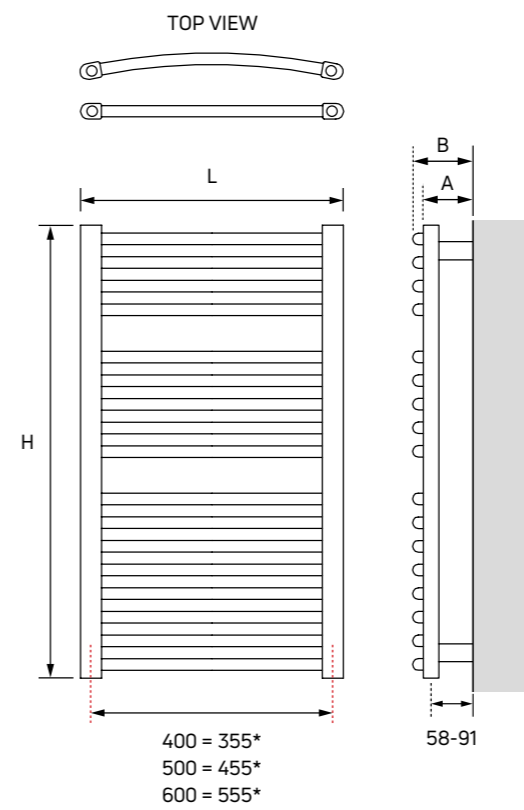

Width (mm)	A (mm)	B (mm)
400	83-106	-
500	83-106	92-115
600	83-106	100-123

A = Straight, B = Curved.

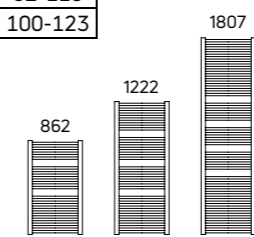

*For dual fuel +/- 70mm.

General specification

- CERTIFICATION**
Manufactured and tested to BS EN 442 & EN 442. Carries the CE & UKCA Mark. Produced under a quality management system - ISO 9001:2015, environmental management system - ISO 14001:2015 and Occupational health and safety management system - OHSAS 18001.
 - CONNECTIONS**
2 x 1/2" BSP as standard.
 - AIR VENTS**
Included in the packaging.
 - OPERATING PRESSURES**
Tested to a pressure of 9.6 bar. Working pressure of up to 7.4 bar.
 - DUAL FUEL**
ECO450 dual fuel heater kit available. Please see page 140.
 - DELIVERY**
2 - 5 working days.
 - BIM**
Visit our website to download the BIM components www.myson.co.uk/bim
 - GUARANTEE**
10 year guarantee from date of purchase against manufacturing defects.
 - COLOUR**
Finished in white (RAL 9016) or chrome.
 - MATERIAL**
Manufactured from steel.
 - ACCESSORIES**
Please see page 140.
 - SYSTEM**
2 pipe pumped indirect domestic and commercial heating applications.
- For more general information, please see page 264.

Weights, water contents & n-coefficients

Model	Weight (kg)	Water Content (l)	n-Coefficient	
			White	Chrome
AVONMORE straight - hydronic				
ECOS84	5.85	3.4	-	1.307
ECOS85	8.00	3.9	1.287	1.302
ECOS86	8.20	4.4	1.278	1.297
ECOS124	8.20	4.7	-	1.317
ECOS125	11.00	5.5	1.312	1.306
ECOS126	12.25	6.3	1.282	1.294
ECOS184	12.15	7.1	-	1.324
ECOS185	14.00	8.2	1.289	1.334
ECOS186	15.20	9.5	1.275	1.345
AVONMORE curved - hydronic				
ECOC85	8.00	3.9	1.287	1.302
ECOC86	8.20	4.4	1.278	1.297
ECOC125	11.00	5.5	1.312	1.306
ECOC126	12.25	6.3	1.282	1.294
ECOC185	14.00	8.2	1.289	1.334
ECOC186	15.20	9.5	1.275	1.345

Technical information & heat outputs

AVONMORE straight - hydronic

Order Code	Nominal Height (H) (mm)	Nominal Length (L) (mm)	Heat Outputs @ ΔT 50°C				Heat Outputs @ ΔT 30°C				Dual Fuel Rating
			Watts		Btu/h		Watts		Btu/h		
			White	Chrome	White	Chrome	White	Chrome	White	Chrome	
ECOS84	862	400	-	234	-	799	-	122	-	416	450
ECOS85	862	500	417	277	1423	945	217	144	739	492	450
ECOS86	862	600	487	328	1662	1119	253	171	863	583	450
ECOS124	1222	400	-	334	-	1140	-	172	-	586	450
ECOS125	1222	500	576	395	1965	1348	301	203	1027	693	450
ECOS126	1222	600	676	467	2307	1593	353	240	1206	819	450
ECOS184	1807	400	-	507	-	1730	-	258	-	880	450
ECOS185	1807	500	866	598	2955	2040	455	304	1552	1038	450
ECOS186	1807	600	1014	705	3460	2405	533	359	1817	1224	450

AVONMORE curved - hydronic

ECOC85	862	500	417	277	1423	945	217	144	739	492	450
ECOC86	862	600	487	328	1662	1119	253	171	863	583	450
ECOC125	1222	500	576	395	1965	1348	301	203	1027	693	450
ECOC126	1222	600	676	467	2307	1593	353	240	1206	819	450
ECOC185	1807	500	866	598	2955	2040	455	304	1552	1038	450
ECOC186	1807	600	1014	705	3460	2405	533	359	1817	1224	450



ANGARA

ANGARA is an elegantly simple ladder rail. Its classic combination of round tubes and straight multi-rail design make it a stylish and practical heating option. It is available in both a white and chrome finish.

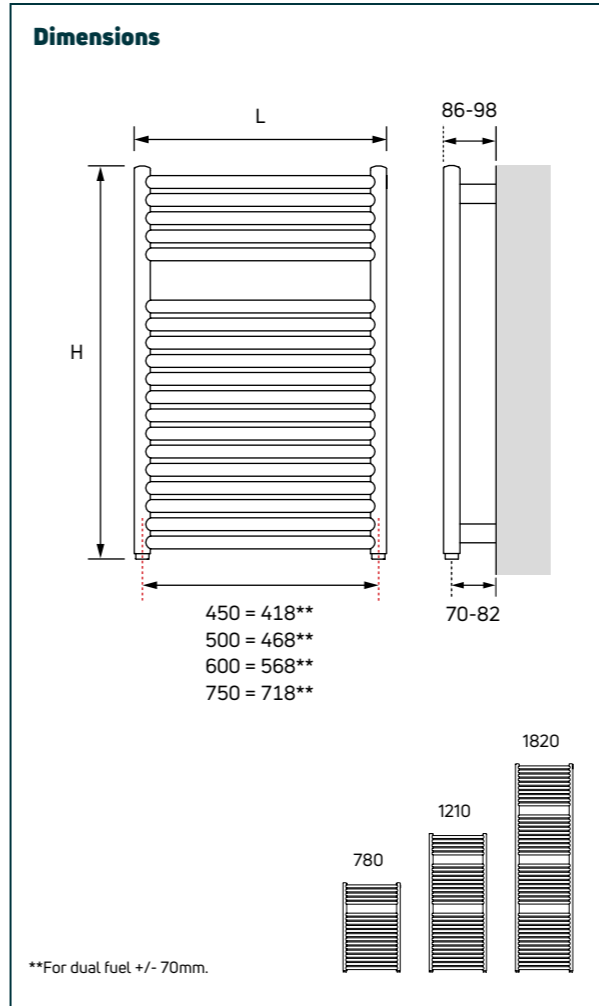

General specification

- CERTIFICATION**
Manufactured and tested to BS EN 442 & EN 442. Carries the CE & UKCA Mark. Produced under a quality management system - ISO 9001:2015, environmental management system - ISO 14001:2015 and Occupational health and safety management system - OHSAS 18001.
- CONNECTIONS**
2 x 1/2" BSP as standard.
- AIR VENTS**
Integrated.
- OPERATING PRESSURES**
Tested to a pressure of 9.6 bar (white) 6.9 bar (chrome). Working pressure of up to 7.4 bar (white) 5.3 bar (chrome).
- GUARANTEE**
10 year guarantee from date of purchase against manufacturing defects.
- COLOUR**
Finished in white (RAL 9016) or chrome.
- MATERIAL**
White product manufactured from steel. Chrome product manufactured from brass.
- ACCESSORIES**
Please see page 140.
- SYSTEM (INDIRECT)**
2 pipe pumped indirect domestic and commercial heating applications.
- SYSTEM (DIRECT)**
Chrome model suitable for most direct central heating or hot water systems. Please refer to page 265 for information on dezincification.
- DUAL FUEL**
MHK dual fuel heater kit options available. Please see table below or page 140 for more information.
- APM[®] TECHNOLOGY**
MHK heater kit comes with APM[®] technology. Please see page 265.
- DELIVERY**
2 - 5 working days. Non-stocked items: 8 - 10 weeks.

For more general information, please see page 264.

Weights & n-coefficients

Model	Weight (kg)	n-Coefficient	
		White	Chrome
MRR145	8.75	1.237	1.252
MRR1	9.00	1.237	1.252
MRR2	11.00	1.237	1.252
MRR3	14.00	1.237	1.252
MRR445	14.75	1.221	1.329
MRR4	15.00	1.221	1.329
MRR5	17.00	1.221	1.329
MRR6	21.00	1.221	1.329
MRR7	22.00	1.236	1.261
MRR8	25.00	1.236	1.261
MRR9	30.00	1.236	1.261

Dual fuel heater kits

Model	Suitable for White Rail	Suitable for Chrome Rail
	Code	Code
MRR145 to MRR6	MHK300	MHK200
MRR7 to MRR9	MHK500	MHK500

Technical information & heat outputs

Order Code		Nominal Height (H) (mm)	Nominal Length (L) (mm)	Heat Outputs @ ΔT 50°C				Heat Outputs @ ΔT 30°C				Dual Fuel Rating	
White	Chrome			Watts		Btu/h		Watts		Btu/h		White	Chrome
				White	Chrome	White	Chrome	White	Chrome	White	Chrome		
MRR145W	MRR145C*	780	450	355	225	1210	769	189	118	645	403	300	200
MRR1W	MRR1C*	780	500	394	251	1344	855	209	132	713	450	300	200
MRR2W	MRR2C*	780	600	473	301	1613	1026	251	158	856	539	300	200
MRR3W	MRR3C*	780	750	591	376	2016	1282	314	192	1071	655	300	200
MRR445W	MRR445C*	1210	450	560	359	1910	1225	300	184	1024	628	300	200
MRR4W	MRR4C*	1210	500	622	399	2122	1361	333	204	1136	696	300	200
MRR5W	MRR5C*	1210	600	746	479	2547	1634	400	245	1365	836	300	200
MRR6W	MRR6C*	1210	750	933	599	3183	2042	500	306	1706	1044	300	200
MRR7W	MRR7C*	1820	500	939	612	3202	2086	499	321	1703	1095	500	500
MRR8W	MRR8C*	1820	600	1126	734	3843	2504	599	385	2044	1314	500	500
MRR9W	MRR9C*	1820	750	1408	917	4803	3130	749	481	2556	1641	500	500

*Non-stock - made to order only.



FERLO

FERLO is a beautiful, high-quality curved towel rail that will add a luxurious finish to any bathroom. With a choice of a white or chrome finish, a wide range of sizes and a classic design, the FERLO makes a great choice for any project.

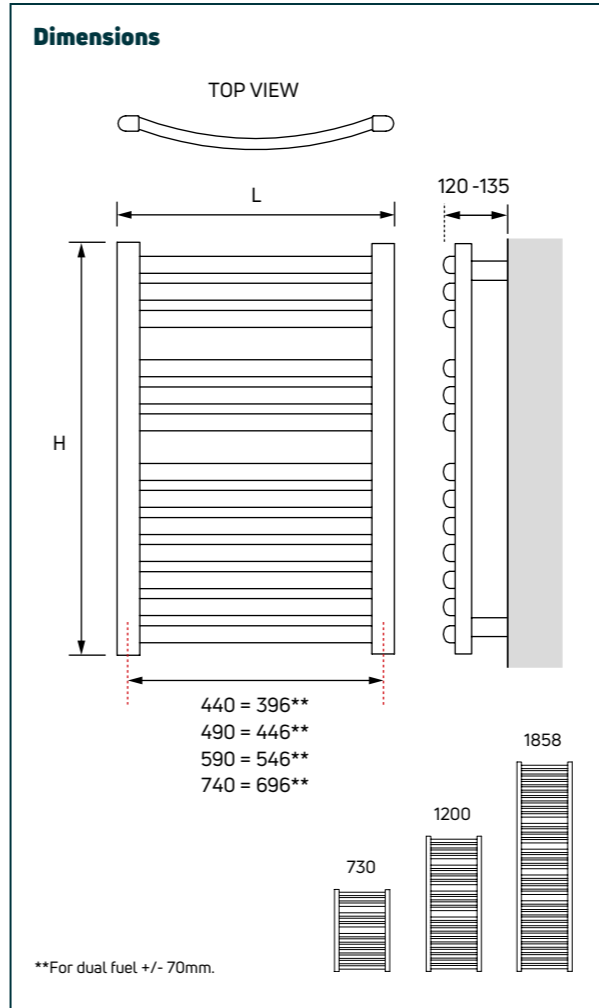

General specification

- CERTIFICATION**
Manufactured and tested to BS EN 442 & EN 442. Carries the CE & UKCA Mark. Produced under a quality management system - ISO 9001:2015, environmental management system - ISO 14001:2015 and Occupational health and safety management system - OHSAS 18001.
- CONNECTIONS**
2 x 1/2" BSP as standard.
- AIR VENTS**
Integrated.
- OPERATING PRESSURES**
Tested to a pressure of 9.6 bar (white) 6.9 bar (chrome). Working pressure of up to 7.4 bar (white) 5.3 bar (chrome).
- GUARANTEE**
10 year guarantee from date of purchase against manufacturing defects.
- DUAL FUEL**
MHK dual fuel heater kit options available. Please see table below or page 140 for more information.
- COLOUR**
Finished in white (RAL 9016) or chrome.
- APM TECHNOLOGY**
MHK heater kit comes with APM technology. Please see page 265.
- MATERIAL**
White product manufactured from steel. Chrome product manufactured from brass.
- DELIVERY**
Non-stocked item: 8 - 10 weeks.
- ACCESSORIES**
Please see page 140.
- SYSTEM (INDIRECT)**
2 pipe pumped indirect domestic and commercial heating applications.
- SYSTEM (DIRECT)**
Chrome model suitable for most direct central heating or hot water systems. Please refer to page 265 for information on dezincification.

For more general information, please see page 264.

Weights & n-coefficients

Model	Weight (kg)	n-Coefficient	
		White	Chrome
CMR145	8.40	1.248	1.255
CMR1	10.20	1.248	1.255
CMR2	10.20	1.248	1.255
CMR3	14.30	1.248	1.255
CMR445	15.70	1.233	1.328
CMR4	17.00	1.233	1.328
CMR5	20.40	1.233	1.328
CMR6	24.00	1.233	1.328
CMR745	25.20	1.232	1.273
CMR7	27.50	1.232	1.273
CMR8	32.20	1.232	1.273
CMR9	39.00	1.232	1.273

Dual fuel heater kits

Model	Suitable for White Rail	Suitable for Chrome Rail
	Code	Code
CMR145 to CMR6	MHK300	MHK200
CMR745 to CMR9	MHK500	MHK500

Technical information & heat outputs

Order Code	Nominal Height (H) (mm)	Nominal Length (L) (mm)	Heat Outputs @ ΔT 50°C				Heat Outputs @ ΔT 30°C				Dual Fuel Rating	
			Watts		Btu/h		Watts		Btu/h		Watts	
			White	Chrome	White	Chrome	White	Chrome	White	Chrome	White	Chrome
CMR145*	730	440	297	195	1015	666	157	103	536	351	300	200
CMR1*	730	490	331	217	1128	740	175	114	597	389	300	200
CMR2*	730	590	397	260	1353	888	210	137	717	467	300	200
CMR3*	730	740	496	326	1691	1111	262	171	894	583	300	200
CMR445*	1200	440	493	322	1681	1098	250	163	853	556	300	200
CMR4*	1200	490	548	358	1868	1220	278	181	949	618	300	200
CMR5*	1200	590	657	429	2242	1464	333	218	1136	744	300	200
CMR6*	1200	740	821	536	2802	1830	417	272	1423	928	300	200
CMR745*	1858	440	755	491	2575	1674	394	256	1344	873	500	500
CMR7*	1858	490	839	545	2861	1860	438	284	1494	969	500	500
CMR8*	1858	590	1006	654	3433	2231	525	341	1791	1163	500	500
CMR9*	1858	740	1258	818	4291	2789	656	427	2238	1457	500	500

*Non-stock - made to order only.



LINDI

LINDI is a beautiful, stylish and eye-catching towel rail that will make a confident statement in any bathroom. Its combination of a square frame and round tube rails creates a unique fusion of styles. It's available in a white and chrome finish and a range of sizes.



Dimensions

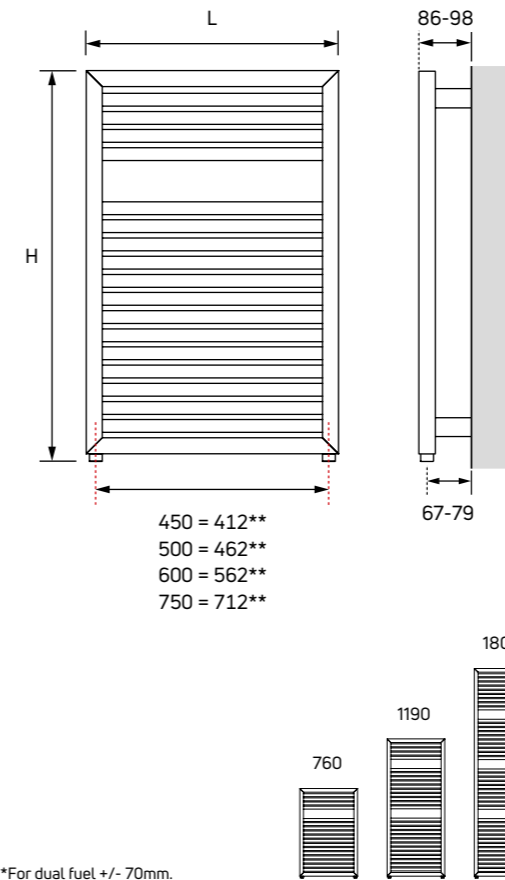

**For dual fuel +/- 70mm.

General specification

- CERTIFICATION**
Manufactured and tested to BS EN 442 & EN 442. Carries the CE & UKCA Mark. Produced under a quality management system - ISO 9001:2015, environmental management system - ISO 14001:2015 and Occupational health and safety management system - OHSAS 18001.
- CONNECTIONS**
2 x 1/2" BSP as standard.
- AIR VENTS**
Integrated.
- OPERATING PRESSURES**
Tested to a pressure of 9.6 bar (white) 6.9 bar (chrome). Working pressure of up to 7.4 bar (white) 5.3 bar (chrome).
- GUARANTEE**
10 year guarantee from date of purchase against manufacturing defects.
- DUAL FUEL**
MHK dual fuel heater kit options available. Please see table below or page 140 for more information.
- COLOUR**
Finished in white (RAL 9016) or chrome.
- APM[®] TECHNOLOGY**
MHK heater kit comes with APM[®] technology. Please see page 265.
- MATERIAL**
White product manufactured from steel. Chrome product manufactured from brass.
- DELIVERY**
Non-stocked item: 8 - 10 weeks.
- ACCESSORIES**
Please see page 140.
- SYSTEM (INDIRECT)**
2 pipe pumped indirect domestic and commercial heating applications.
- SYSTEM (DIRECT)**
Chrome model suitable for most direct central heating or hot water systems. Please refer to page 265 for information on dezincification.

For more general information, please see page 264.

Weights & n-coefficients

Model	Weight (kg)	n-Coefficient	
		White	Chrome
MRS145	9.75	1.268	1.276
MRS1	10.00	1.268	1.276
MRS2	13.00	1.268	1.276
MRS3	15.00	1.268	1.276
MRS445	15.75	1.240	1.287
MRS4	16.00	1.240	1.287
MRS5	19.40	1.240	1.287
MRS6	23.00	1.240	1.287
MRS7	26.50	1.242	1.310
MRS8	31.20	1.242	1.310

Dual fuel heater kits

Model	Suitable for White Rail	Suitable for Chrome Rail
	Code	Code
MRS145 to MRS6	MHK300	MHK200
MRS7 to MRS8	MHK500	MHK500

Technical information & heat outputs

Order Code	Nominal Height (H) (mm)	Nominal Length (L) (mm)	Heat Outputs @ ΔT 50°C				Heat Outputs @ ΔT 30°C				Dual Fuel Rating	
			Watts		Btu/h		Watts		Btu/h		Watts	
			White	Chrome	White	Chrome	White	Chrome	White	Chrome	White	Chrome
MRS145*	760	450	351	239	1198	817	184	125	628	427	300	200
MRS1*	760	500	390	266	1331	908	204	139	696	474	300	200
MRS2*	760	600	468	319	1597	1089	245	166	836	566	300	200
MRS3*	760	750	585	399	1996	1361	306	208	1044	710	300	200
MRS445*	1190	450	576	359	1965	1225	306	186	1044	635	300	200
MRS4*	1190	500	640	399	2184	1361	340	207	1160	706	300	200
MRS5*	1190	600	768	479	2620	1634	408	248	1392	846	300	200
MRS6*	1190	750	960	599	3276	2042	509	310	1737	1058	300	200
MRS7*	1800	500	959	613	3270	2092	508	314	1733	1071	500	500
MRS8*	1800	600	1150	736	3924	2510	610	377	2081	1286	500	500

*Non-stock - made to order only.



TYNE

TYNE is a classic tube-on-tube ladder rail. It has a light, modern design and provides a discrete but stylish presence in any bathroom. It is available in a range of sizes and comes with a dual fuel heater option.

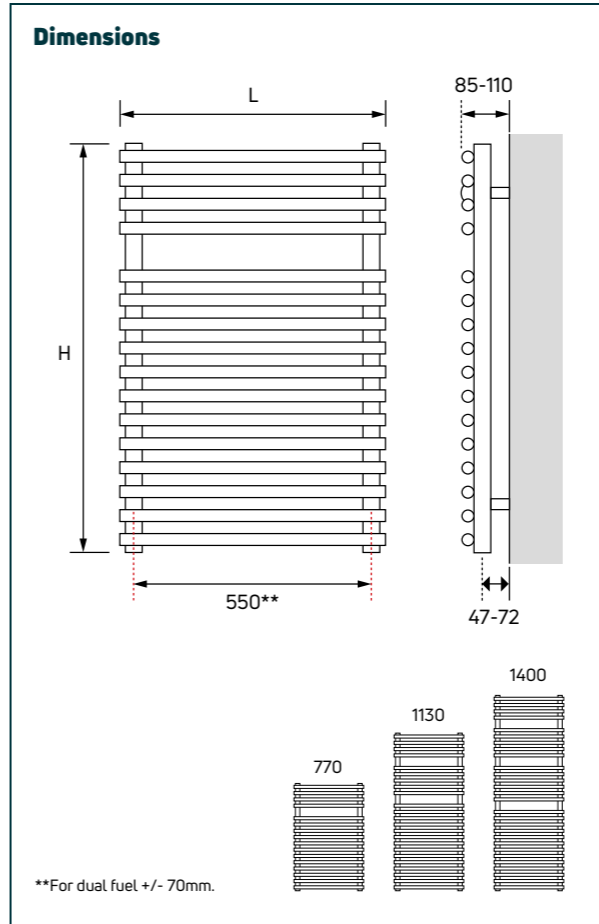

General specification

- CERTIFICATION**
Manufactured and tested to BS EN 442 & EN 442. Carries the CE & UKCA Mark. Produced under a quality management system - ISO 9001:2015, environmental management system - ISO 14001:2015 and Occupational health and safety management system - OHSAS 18001.
- CONNECTIONS**
2 x 1/2" BSP as standard.
- AIR VENTS**
Included in the packaging.
- OPERATING PRESSURES**
Tested to a pressure of 9.6 bar.
Working pressure of up to 7.4 bar.
- DUAL FUEL**
ECO450 dual fuel heater kit available. Please see page 140.
- GUARANTEE**
10 year guarantee from date of purchase against manufacturing defects.
- COLOUR**
Finished in chrome.
- MATERIAL**
Manufactured from steel.
- ACCESSORIES**
Please see page 140.
- SYSTEM**
2 pipe pumped indirect domestic and commercial heating applications.
- DELIVERY**
2 - 5 working days.
Non-stocked items: 8 - 10 weeks.

For more general information, please see page 264.

Weights, water contents & n-coefficients

Model	Weight (kg)	Water Content (l)	n-Coefficient
TUB1	9.30	3.5	1.231
TUB2	13.00	5.0	1.251
TUB3	16.20	6.7	1.253

Technical information & heat outputs

Order Code	Nominal Height (H) (mm)	Nominal Length (L) (mm)	Heat Outputs @ ΔT 50°C		Heat Outputs @ ΔT 30°C		Dual Fuel Rating
			Watts	Btu/h	Watts	Btu/h	
TUB1*	770	600	318	1085	170	580	450
TUB2	1130	600	448	1529	236	805	450
TUB3*	1400	600	547	1866	288	983	450

*Non-stock - made to order only.









TOWEL WARMERS

Accessories

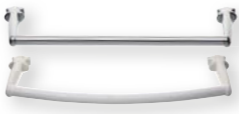
Product	Description	Order Code	Chrome
Discreet Wire Kit 	Covers the element end and cable. Suitable for the entire MYSON APM® electric range and selected dual fuel models.	DISCREET*	✓
Cone Wire Kit 	Covers the element end. Suitable for the entire MYSON APM® electric range and selected dual fuel models.	CONE*	✓
Heater Kits ECO450 & MHK 	Dual fuel heater kit. Suitable for: KASAI, INTERLUDE, MARANO, AVONMORE & TYNE. Multi-rail heater kit including APM® technology. Suitable for: LINDI, ANGARA & FERLO.	ECO450 MHK200 MHK300 MHK500	✓ ✓ ✓ ✓
Heating Element 	Dual fuel heating elements with APM® technology. Suitable for: STOUR, AWE, DEE, INN, SAXBY, THIRLMERE & ULLSWATER.	PTC75 PTC100* PTC150* PTC200* PTC300 PTC400 PTC500	✓ ✓ ✓ ✓ ✓ ✓
Sleeving Kit 	Covers water pipes and the holes through which they come. ½" to suit the valves used. Suitable for floor standing products.	SK15*	✓

For more information on APM® technology please see page 265.

*Non-stock - made to order only.

Product	Description	Order Code	Chrome	White
Towel Peg 	Suitable for: FERLO, ANGARA, LINDI, AVONMORE, TYNE, FATALA & KASAI.	TPEG1	✓	-
Towel Peg 	Suitable for: FERLO, ANGARA, LINDI, AVONMORE, TYNE, FATALA & KASAI.	TPEG3*	✓ (Pack of 2)	✓ (Pack of 2)
Towel Peg 	Suitable for: FERLO, ANGARA, LINDI, AVONMORE, TYNE, FATALA & KASAI.	TPEG4*	✓ (Pack of 2)	✓ (Pack of 2)
Towel Rail 	500mm wide suitable for: FERLO, ANGARA, LINDI, AVONMORE, TYNE, FATALA & KASAI.	TRAIL1*	✓ (Straight & Curved)	✓ (Straight & Curved)
Towel Rail 	600mm wide suitable for: FERLO, ANGARA, LINDI, AVONMORE, TYNE, FATALA & KASAI.	TRAIL2*	✓ (Straight & Curved)	✓ (Straight & Curved)
Towel Rail 	Suitable for: FERLO, ANGARA, LINDI, AVONMORE, TYNE, FATALA & KASAI.	TRAIL3*	✓	✓
Towel Ring 	Suitable for: FATALA & KASAI.	TRING*	✓	-
Towel Ring 	Suitable for: FERLO, ANGARA, LINDI & AVONMORE.	TRING1*	✓	✓
Laundry Rail (chrome) 	Suitable for: KASAI & FATALA.	LRAIL*	✓	-
Glass Shelf (chrome) 	Suitable for: KASAI & FATALA.	GSHELF*	✓	-

*Non-stock - made to order only.



Fan convectors

All MYSON fan convectors are made up of similar core components, offering a range of features:

- A copper pipe heat exchanger with aluminium fins, which gives a huge surface area
- A motor and fan that force air over the heat exchanger
- Hot water temperature sensors that determine if the heating system is running or not
- Controls that allow the user to setup the product to suit their needs

The way fan convectors activate is usually via the water side temperature sensor. If the water in the heating system is hot enough then the fans will switch on and if the heating system switches off and the water cools down then the fans will deactivate.

The intelligent new iVECTOR S2 offers both heating and cooling functionality when combined with a reversible heat pump or separate cooling device.



Clever by design, MYSON's innovative, plinth heaters provide a space saving heating solution for kitchens where vital wall space is often taken up by a traditional radiator. The discrete KICKSPACE® can be fitted easily under units allowing more interior design freedom and rapid space heating using a high surface area heat exchanger.



ELECTRIC* KICKSPACE® 500E & 600E ECO

The electric KICKSPACE® is perfect for properties without a central heating system or in rooms where there is no existing pipework. Quick and easy to fit, the 500E ECO can provide a heat output up to 2kW while the 600E ECO is up to 3kW.



500E & 600E ECO

Hydronic - KICKSPACE® 500, 600 & 800

The most popular range of KICKSPACE® are the hydronic models that integrate directly into the existing central heating system. These three models provide heat outputs from 1kW to 2.6kW, providing warmth for any room. The fan on these models will activate with the central heating system.

Low voltage hydronic - KICKSPACE® 600-12V

This unique model means you get all the advantages of KICKSPACE® but it can be used in areas of high humidity, such as bathrooms and en-suites.



500

DUO KICKSPACE® 500 DUO ECO

The KICKSPACE® 500 DUO ECO model combines the advantages of the hydronic and electric models, with the flexibility to switch between central heating and electric modes.



500 DUO ECO

Hydronic - KICKSPACE® 80S & 80D

The KICKSPACE® 80S and 80D are a lower height and suitable for Ikea and European style kitchen units. They have all the features of the KICKSPACE® and come in a single and double width for extra output.



80S

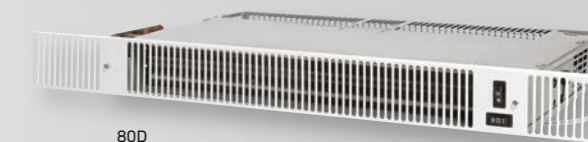

80D



**Wireless
Thermostat**
Supplied with
KICKSPACE®
DUO ECO models

KICKSPACE®

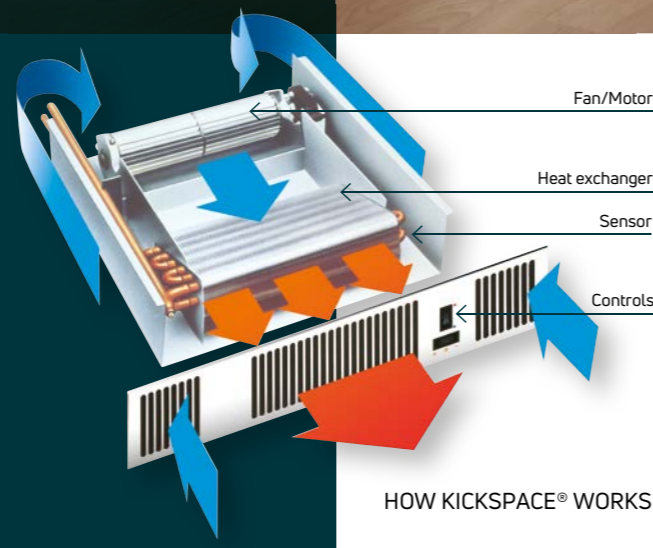

HOW KICKSPACE® WORKS

*Due to a component supply issue, KICKSPACE® Electric models are temporarily unavailable.

KICKSPACE®

Controls & accessories

Hydronic controls



Electric/Duo* controls

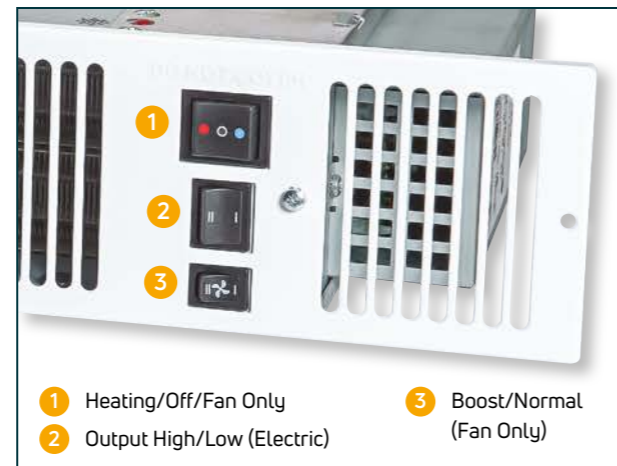

*DUO = Electric/Hot Water

KICKSPACE® Grilles

KICKSPACE® grilles are available in four finishes, white, black, chrome and brushed stainless steel.

All KICKSPACE® models are supplied with white grilles however alternative finishes can be purchased separately.

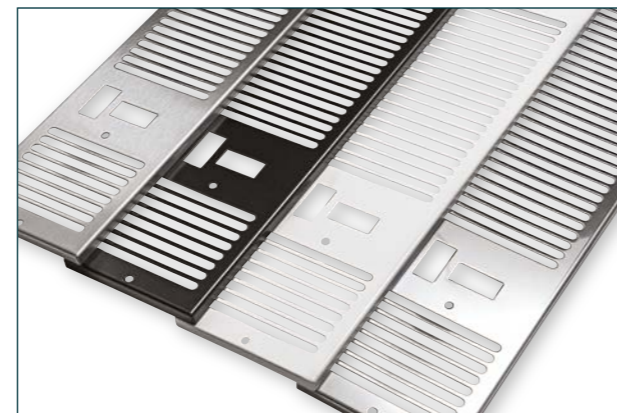

External Thermostatic Controls suitable for Hydronic KICKSPACE® (500, 600, 600-12V, 800, 80S and 80D)

The following range of controls are compatible with our hydronic KICKSPACE® models:

UNISENZA - Room Thermostat is an analogue dial thermostat, for more information please refer to page 250.

MPRT - Programmable Room Thermostat is an easy to use digital programmable thermostat that incorporates our Smart Start technology, for more information please refer to page 254.

TOUCH - A touch screen programmable thermostat that incorporates our Smart Start Technology, for more information please refer to page 255.

TOUCH2 WiFi - Second generation touch screen thermostats with touch sensitive controls giving you the ability to control over WiFi from your smart phone**, for more information please refer to page 256.

**TOUCH2 WiFi Hub required for WiFi control - purchased separately.



UNISENZA Dial Thermostat



MPRT



TOUCH



TOUCH2 WiFi

For wiring information please visit www.myson.co.uk, go to your chosen KICKSPACE® product page via the fan convector tab and click downloads.

KICKSPACE®

General specification & technical information



CERTIFICATION

Produced under a quality management system - ISO 9001:2015, environmental management system - ISO 14001:2015 and Occupational health and safety management system - ISO 45001:2018. Carries the CE mark and conforms to the Low Voltage Directive 2014/35/EU and the EMC Directive 2014/30/EU. Hydronic/Duo outputs are tested to BS 4856 Part 1. Sound levels are tested to EN 23741. Electric and Duo models are also tested to RED 2014/53/EU. BEAB Approved.



GUARANTEE

2 year guarantee from date of purchase against manufacturing defects.



COLOUR

Supplied grilles finished in white (RAL 9016). Black (RAL 9011), chrome and brushed stainless steel can be purchased separately.



ACCESSORIES

Optional coloured grilles are available for the full KICKSPACE® range, please see page 149.

A range of controls are also available for KICKSPACE® 500, 600, 600-12V, 800, 80S & 80D, note they are currently not compatible with KICKSPACE® Electric or Duo models, for more information please refer to page 149.



SYSTEM

Closed circulation, 2 pipe pump assisted central heating systems.



CONNECTIONS

Hydronic/Duo: 15mm copper pipes. Compression: Compression fitting flexible hoses supplied.



AIR VENTS

Integrated (Hydronic/Duo only).



OPERATING PRESSURES

Hydronic/Duo - tested to a pressure of 20 bar, working pressure of up to 10 bar.



OPERATING TEMPERATURE

Hydronic/Duo - maximum 90°C.



ELECTRICAL SUPPLY

220-240V-50Hz.
KICKSPACE® 500, 600, 600-12V, 800, 80S & 80D require a supply fused at 3A.
KICKSPACE® 500 DUO ECO requires a supply fused at 5A.
KICKSPACE® 500E ECO requires a supply fused at 10A.
KICKSPACE® 600E ECO requires a supply fused at 13A.



DELIVERY

2 - 5 working days.



ECO DESIGN DIRECTIVE

Electric and Duo models conform to the standards (EU) 2015/1188.

For more general information, please see page 264.

Hydronic models

Dimensions	Fan Speed	Model							
		500	600	800	600-12V	500 DUO ECO	80S	80D	
Nominal Height (mm)	-	101	101	101	101	101	80	80	
Depth (mm)	-	309	309	309	309	330	301	301	
Length (mm)	-	496	550	603	550	496	560	760	

Sound Levels*	Sound Pressure (dBA) (at 2.5m)	Normal	Model							
			500	600	800	600-12V	500 DUO ECO	80S	80D	
		Boost	25.7	26.4	28.5	29.4	25.7	24.5	21.8	
			38.1	37.2	49.8	39.0	38.1	31.4	35.6	

Weight, Water Content & Motor Power	Unit Weight (kg)	-	Model							
			500	600	800	600-12V	500 DUO ECO	80S	80D	
			Water Content (l)	0.26	0.30	0.34	0.30	0.26	0.17	0.25
	Motor Power (W - max.)	-	25	40	40	40	25	13	17	

Air Flow Rates	Air Flow (m³/h)	Normal	Model							
			500	600	800	600-12V	500 DUO ECO	80S	80D	
		Boost	70	106	139	106	70	68	87	
			90	138	210	138	90	71	90	
	Air Flow (ft³/h)	Normal	2471	3742	4908	3742	2471	2313	3192	
			Boost	3177	4872	7415	4872	3117	2511	3069

Approximate Hydraulic Resistance	mm wg	l/h	Model							
			500	600	800	600-12V	500 DUO ECO	80S	80D	
		kPa	455	788	1046	911	1046	788	592	613
			340	488	625	544	625	488	372	439
			227	231	326	258	326	231	207	295
			113	82	95	82	95	82	95	176
			455	7.7	10.3	8.9	10.3	7.7	5.8	6.0
			340	4.8	6.1	5.3	6.1	4.8	3.6	4.3
			227	2.3	3.2	2.5	3.2	2.3	2.0	2.9
113	0.8	0.9	0.8	0.9	0.8	0.9	1.7			

*Sound levels tested in accordance with EN 23741.

†Includes transformer.

KICKSPACE®

Technical information (cont...)

Electric models

		Fan Speed	Model	
			500E ECO	600E ECO
Dimensions	Nominal Height (mm)	-	101	101
	Nominal Depth (mm)	-	203	203
	Nominal Length (mm)	-	496	550
Sound Levels*	Sound Pressure (dBA) (at 2.5m)	Normal	25.7	26.4
		Boost	38.1	37.2
Weight	Unit Weight (kg)	-	3.1	3.6
Air Flow Rates	Air Flow (m³/h)	Normal	70	106
		Boost	90	138
	Air Flow (ft³/h)	Normal	2471	3742
		Boost	3177	4872

*Sound levels tested in accordance with EN 23741.

Dimensions

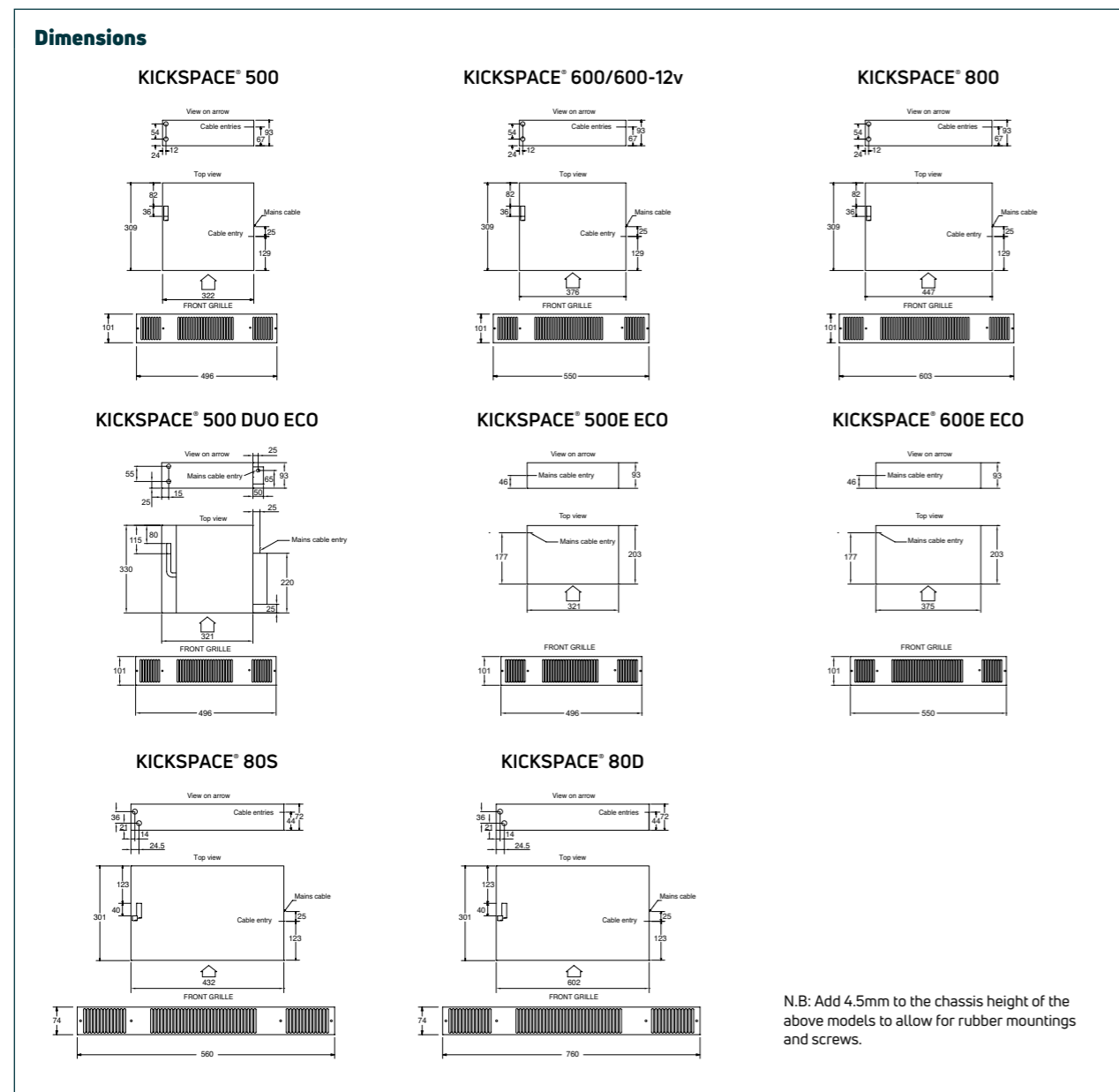

KICKSPACE®

Heat outputs

Hydronic models

Model	Fan Speed	Heat Outputs @ ΔT 50°C		Heat Outputs @ ΔT 30°C		Grille Supplied	Order Code
		Watts	Btu/h	Watts	Btu/h		
KICKSPACE® 500	Normal	896	3057	566	1930	White	3KICK500
	Boost	1166	3980	683	2331		
KICKSPACE® 600	Normal	1278	4361	729	2486	White	3KICK600
	Boost	1625	5545	939	3203		
KICKSPACE® 800	Normal	1707	5824	1077	3675	White	3KICK800
	Boost	2192	7478	1289	4397		
KICKSPACE® 80S	Normal	755	2576	455	1552	White	3KICK80S
	Boost	876	2989	509	1737		
KICKSPACE® 80D	Normal	1023	3490	624	2129	White	3KICK80D
	Boost	1169	3989	707	2412		

Low voltage hydronic model

Model	Fan Speed	Watts	Btu/h	Watts	Btu/h	Grille Supplied	Order Code
KICKSPACE® 600-12V	Normal	1278	4361	729	2486	White	3KICK60012V
	Boost	1625	5545	939	3203		

Hydronic-electric model

Model	Fan Speed	Watts	Btu/h	Watts	Btu/h	Grille Supplied	Order Code
KICKSPACE® 500 DUO ECO*	Normal	896	3057	566	1930	White	3KICK500DUOECO
	Boost	1166	3980	683	2331		

Heat outputs tested in accordance with BS 4856 Part 1.
*The unit will operate on either fan speed to provide 1kW of heating in electric mode.

Flow Rate: 340 ltr/h (75 gal/h)

Flow Rate Correction Factors:

455 ltr/h (100 gal/h) multiply output by 1.03

227 ltr/h (50 gal/h) multiply output by 0.96

113 ltr/h (25 gal/h) multiply output by 0.85

Electric models**

Model	Fan Speed	Heat Outputs		Grille Supplied	Order Code
		Watts	Btu/h		
KICKSPACE® 500E ECO	Normal	1000	3412	White	3KICK500EECO**
	Boost	2000	6824		
KICKSPACE® 600E ECO	Normal	1500	5118	White	3KICK600EECO**
	Boost	3000	10236		

**Due to a component supply issue, KICKSPACE® Electric models are temporarily unavailable.

KICKSPACE® grilles

Colour	Order Code - KICKSPACE® Model						
	500	600 / 600-12V	800	500E ECO / 500 DUO ECO	600E ECO	80S	80D
White	WG500	WG600	3WG800	EWG500	EWG600	WG80S	WG80D
Black	BLG500	BLG600	3BLG800	EBLG500	EBLG600	BLG80S	BLG80D
Chrome	CG500	CG600	3CG800	ECG500	ECG600	CG80S	CG80D
Brushed Stainless Steel	BSG500	BSG600	3BSG800	EBSG500	EBSG600	BSG80S	BSG80D

KICKSPACE® controls & accessories

Product	Order Code
UNISENZA Dial Thermostat	UNIDIAL
MPRT Programmable Room Thermostat	MPRT
MPRT Programmable Room Thermostat, Chrome Fascia	MPRTCR
TOUCH Screen Programmable Room Thermostat	TOUCH
TOUCH2 WiFi Touch Pad Programmable Room Thermostat for 'Smart Phone' Control & Control Hub	T2AHWIFI
TOUCH2 WiFi Touch Pad Programmable Room Thermostat for 'Smart Phone' Control	T2WIFI
KICKSPACE® Flexible Hoses (Pair)	FP

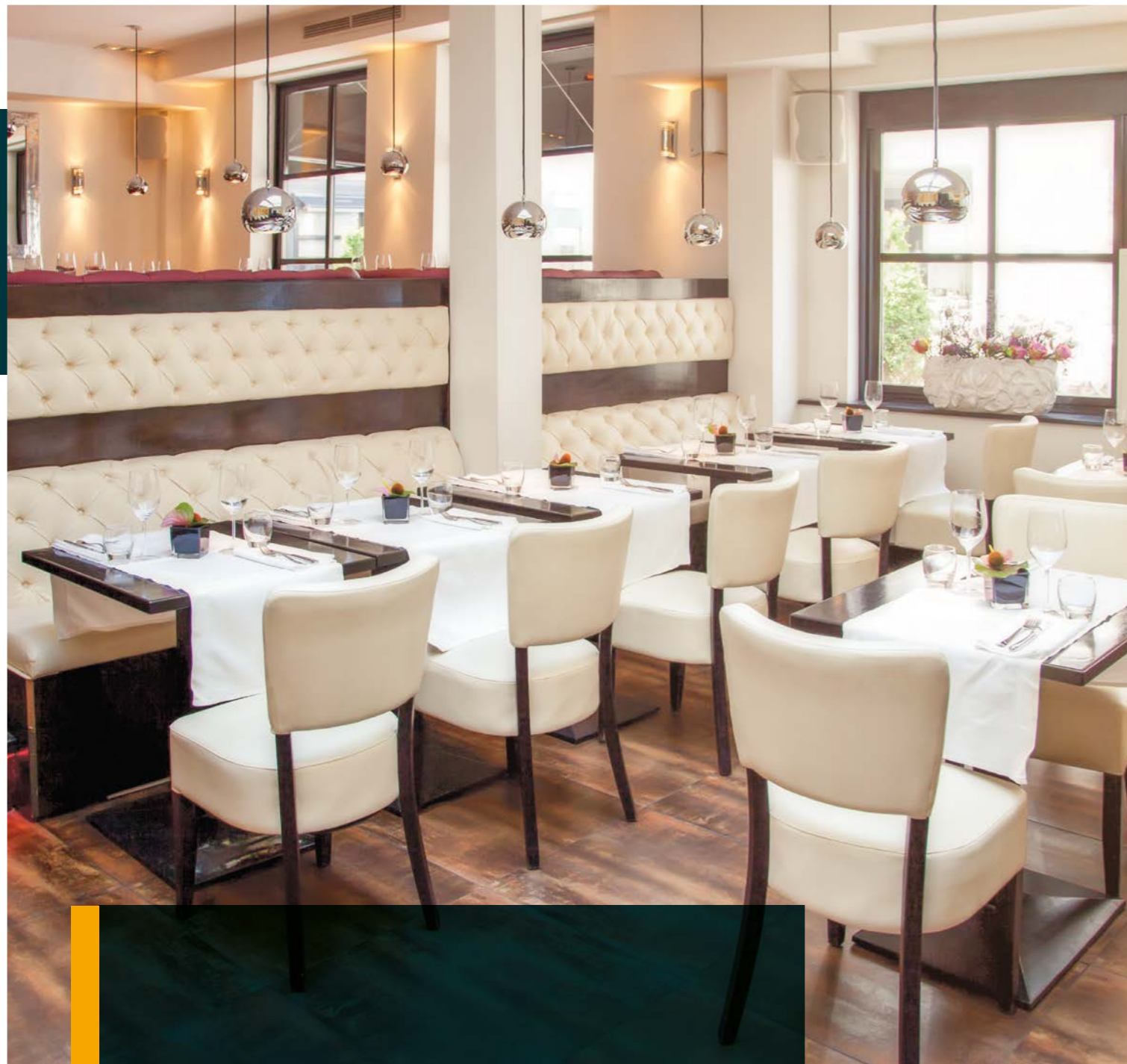

WALLMOUNT RANGE (HI-LINE & LO-LINE)

The wallmount range provides rapid heat using a small amount of space. They are perfect for maximising the amount of available space in any room. They provide solutions for semi-commercial applications such as retail or restaurant dining spaces. They can also be a great solution for domestic properties in areas such as conservatories or narrow areas that have large heating demands.

HI-LINE Range

MYSON HI-LINE is a range of high level, wall mounted fan convectors that can utilise unused space above a door. They provide rapid heat from above and incorporate technology that is generations ahead of the competition. HI-LINE connects easily to a central heating system.

- Range includes the discreet HI-LINE RC and a low voltage 12V model
- Perfect for domestic and commercial applications, such as restaurants and offices
- HI-LINE RC is fitted with digital controls and supplied with a handheld remote
- HI-LINE LV model is ideally suited to bathroom applications where safety matters most

LO-LINE RC

MYSON LO-LINE RC is a low level, wall mounted fan convector that delivers high heat outputs, quickly. Ideal for areas such as conservatories, which feature limited wall space and require instant warmth during occasional use. Easily connects to an existing central heating system.

- Available in four sizes that increase in performance
- Fitted with digital controls and supplied with a handheld remote control







LO-LINE RC









HI-LINE RC

WALLMOUNT RANGE

General specification

-  **CERTIFICATION**
Produced under a quality management system - ISO 9001:2015, environmental management system - ISO 14001:2015 and Occupational health and safety management system - ISO 45001:2018. Carries the CE mark and conforms to the Low Voltage Directive 2014/35/EU and the EMC Directive 2014/30/EU. Outputs are tested to BS 4856 Part 1. Sound levels are tested to EN 23741.
-  **GUARANTEE**
2 year guarantee from date of purchase against manufacturing defects.
-  **COLOUR**
Finished in white (RAL 9016) powder coating.
-  **ANTI-BACTERIAL PAINT**
Coating to suppress bacterial growth.
-  **SYSTEM**
Closed circulation, 2 pipe pump assisted central heating systems.

-  **CONNECTIONS**
15mm copper pipe (HI-LINE RC and LO-LINE RC).
-  **AIR VENTS**
Integrated with LO-LINE RC. Excluded from HI-LINE range.
-  **OPERATING PRESSURES**
Tested to a pressure of 20 bar. Working pressure of up to 10 bar.
-  **OPERATING TEMPERATURE**
Maximum 90°C.
-  **ELECTRICAL SUPPLY**
220-240V - 50Hz fused at 3A.
-  **DELIVERY**
2 - 5 working days.

For more general information, please see page 264.

Controls

HI-LINE RC and LO-LINE RC units are supplied with an electronic infra-red remote control system with the following features:

- Automatic room temperature control
- Fan only option for ambient air circulation
- Three fan speeds
- Unit mounted controls and display
- Unit control panel electronic tamper proof lock
- Displayed temperature calibration system

HI-LINE LV units are fitted with a switch offering high and low fan speeds and off selection. A low limit thermostat is fitted to the unit to ensure that the fan stops after the heating system is switched off.



REMOTE CONTROL SUPPLIED (Excluding LV Model)



CONTROL PANEL (Excluding LV Model)

WALLMOUNT RANGE

Technical information

HI-LINE RC, HI-LINE LV dimensions & fixings

- Maximum installation height is 2.13m to the underside of the unit
- Minimum installation height is 1.8m to the underside of the unit
- Maximum ceiling height is 3m
- Minimum clearance each side is 100mm
- Minimum top clearance is 50mm
- Please note the transformer is mounted inside the unit (LV model only)

If installing the product above the recommended height consider adding additional margin to the heat loss, or install de-stratification fans.

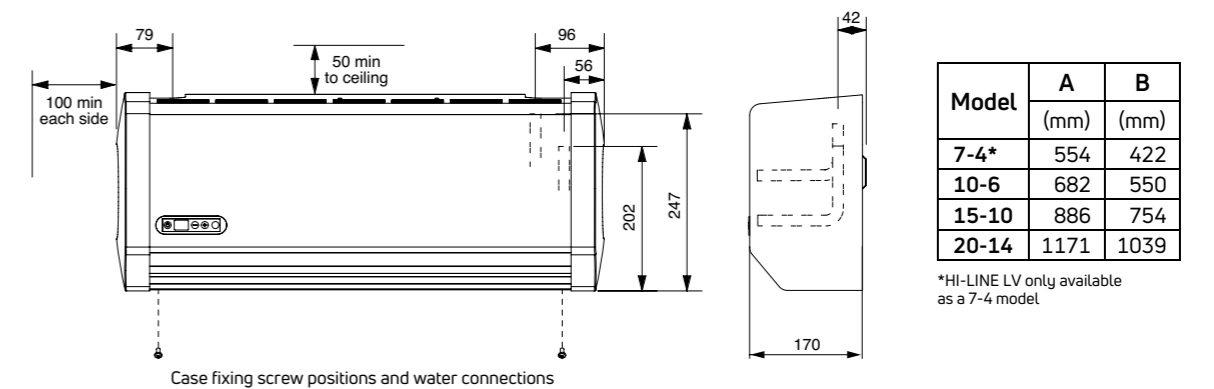

Model	A (mm)	B (mm)
7-4*	554	422
10-6	682	550
15-10	886	754
20-14	1171	1039

*HI-LINE LV only available as a 7-4 model.

LO-LINE RC dimensions & fixings

- Minimum installation height is 150mm to the underside of the unit
- Minimum clearance each side is 100mm

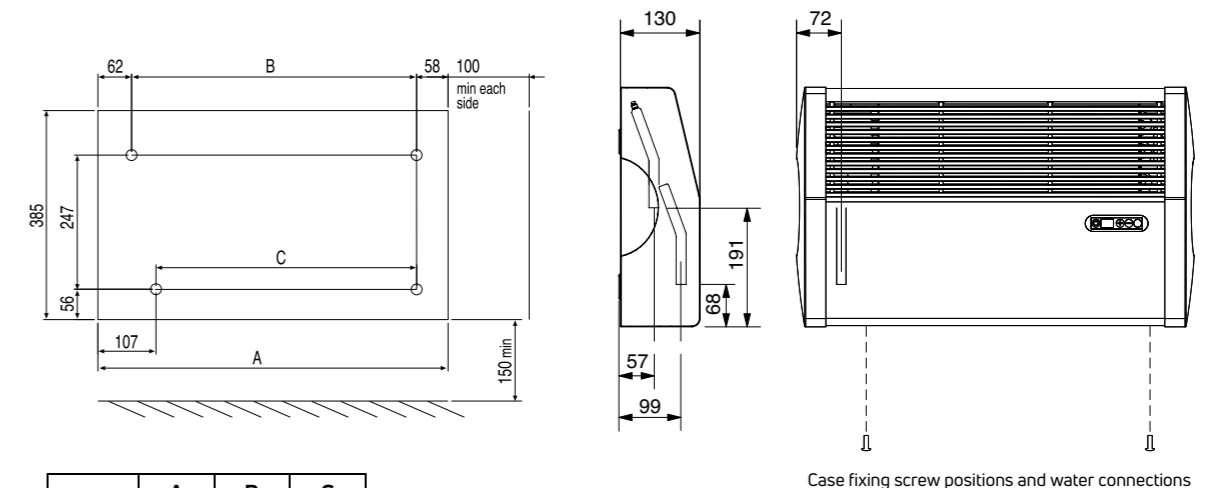

Model	A (mm)	B (mm)	C (mm)
6-4	523	404	359
9-6	645	526	481
14-10	854	733	681
19-15	1138	1018	974

WALLMOUNT RANGE

Technical information (cont...)

		Fan Speed	Model				
			HI-LINE RC				HI-LINE LV
			7-4	10-6	15-10	20-14	7-4
Dimensions	Nominal Height (mm)	-	277	277	277	277	277
	Nominal Depth (mm)	-	170	170	170	170	170
	Nominal Length (mm)	-	554	682	887	1171	554
Sound Levels*	Sound Pressure (dBA) (at 2.5m)	Normal	23.4	23.5	28.8	33.3	16.6
		Medium	32.5	30.8	35.4	38.7	-
		Boost	43.3	37.2	45.6	45.4	32.5
Weight, Water Content & Motor Power	Unpacked Weight (kg)	-	7.4	8.9	11.3	14.7	7.4
	Water Content (l)	-	0.30	0.32	0.56	0.77	0.3
	Motor Power (W - max.)	-	35	35	62	80	30
Air Flow Rates	Air Flow (m³/h)	Normal	81	143	207	285	81
		Medium	105	171	276	371	-
		Boost	133	220	333	431	133
	Air Flow (ft³/h)	Normal	2859	5048	7307	10061	2859
		Medium	3707	6036	9743	13096	-
		Boost	4695	7766	11755	15214	4695

		ltr/h	Model				
			HI-LINE RC				HI-LINE LV
			7-4	10-6	15-10	20-14	7-4
Approximate Hydraulic Resistance	mm wg	455	1084	1240	1500	1774	1084
		341	798	657	905	1140	798
		227	350	327	450	565	350
		113	134	105	157	221	134
		455	9.4	12.12	14.7	17.42	9.4
	kPa	341	7.7	6.42	8.9	11.2	7.7
		227	3.5	3.25	4.37	5.5	3.5
		113	1.4	1.1	1.57	2.1	1.4

*Sound levels tested in accordance with EN 23741.

		Fan Speed	Model			
			LO-LINE RC			
			6-4	9-6	14-10	19-15
Dimensions	Nominal Height (mm)	-	385	385	385	385
	Nominal Depth (mm)	-	130	130	130	130
	Nominal Length (mm)	-	523	645	854	1138
Sound Levels*	Sound Pressure (dBA) (at 2.5m)	Normal	23.7	21.6	23.1	27.2
		Medium	31.7	29.6	28.5	31.8
		Boost	40.7	38	40.1	38.6
Weight, Water Content & Motor Power	Unpacked Weight (kg)	-	7.7	9.1	12.7	15.7
	Water Content (l)	-	0.3	0.32	0.56	0.75
	Motor Power (W - max.)	-	35	35	62	80
Air Flow Rates	Air Flow (m³/h)	Normal	65	112	160	241
		Medium	86	129	200	288
		Boost	122	175	288	335
	Air Flow (ft³/h)	Normal	2295	3954	5648	8507
		Medium	3036	4554	7060	10166
		Boost	4307	6178	10166	11826

		ltr/h	Model			
			LO-LINE RC			
			6-4	9-6	14-10	19-15
Approximate Hydraulic Resistance	mm wg	455	910	998	1240	1670
		340	514	520	719	954
		227	235	121	324	469
		113	47	97	75	77
		455	8.98	9.85	12.20	16.40
	kPa	340	5.06	5.10	7.00	9.40
		227	2.35	1.18	3.20	4.60
		113	0.45	0.97	0.75	0.82

*Sound levels tested in accordance with EN 23741.

WALLMOUNT RANGE

Heat outputs

HI-LINE RC

Model	Fan Speed	Heat Outputs @ ΔT 50°C		Heat Outputs @ ΔT 30°C		Order Code
		Watts	Btu/h	Watts	Btu/h	
HI-LINE RC 7-4	Normal	930	3172	541	1845	HIRC7
	Medium	1292	4410	752	2565	
	Boost	1702	5808	991	3380	
HI-LINE RC 10-6	Normal	1610	5493	937	3197	HIRC10
	Medium	1959	6683	1140	3889	
	Boost	2521	8602	1467	5005	
HI-LINE RC 15-10	Normal	2459	8390	1431	4881	HIRC15
	Medium	2783	9496	1620	5526	
	Boost	3690	12590	2147	7327	
HI-LINE RC 20-14	Normal	3468	11831	2018	6884	HIRC20
	Medium	4380	14944	2548	8695	
	Boost	4959	16921	2889	9858	

HI-LINE LV

Model	Fan Speed	Watts	Btu/h	Watts	Btu/h	Order Code
HI-LINE LV 7-4	Normal	930	3173	541	1846	HILV
	Boost	1702	5807	991	3381	

LO-LINE RC

Model	Fan Speed	Watts	Btu/h	Watts	Btu/h	Order Code
		916	3126	564	1923	
LO-LINE RC 6-4	Normal	916	3126	564	1923	LORC6
	Medium	1043	3558	641	2187	
	Boost	1437	4904	883	3014	
LO-LINE RC 9-6	Normal	1358	4633	834	2847	LORC9
	Medium	1777	6064	1093	3728	
	Boost	2240	7643	1377	4699	
LO-LINE RC 14-10	Normal	2377	8111	1461	4986	LORC14
	Medium	2928	9989	1800	6140	
	Boost	3467	11829	2131	7272	
LO-LINE RC 19-15	Normal	3613	12327	2221	7578	LORC19
	Medium	4144	14140	2548	8692	
	Boost	4640	15831	2852	9731	

Heat outputs tested in accordance with BS 4856 Part 1.

Flow Rate (all products): 340 ltr/h (75 gal/h)

Flow Rate Correction Factors:

(HI-LINE RC, HI-LINE LV & LO-LINE RC)

455 ltr/h (100 gal/h) multiply output by 1.06

227 ltr/h (50 gal/h) multiply output by 0.96

113 ltr/h (25 gal/h) multiply output by 0.85



NEW!

iVECTOR S2

New iVECTOR S2 is the whisper-quiet fan convector from MYSON. With an attractive, compact design the iVECTOR S2 is capable of high heating performance whilst operating at low temperatures and with low water content. This provides efficient energy use without sacrificing outputs.

When combined with a reversible heat pump or a separate cooling source, the iVECTOR S2 can offer both heating and cooling functions, making it a perfect solution for both commercial and domestic use.



Silence...listen

At last here is a fan convector that offers innovative solutions for heating and cooling systems. Thanks to its ingenious and highly-accurate controls the iVECTOR S2 provides optimal comfort all year round. It is equipped with a highly-efficient DC motor, with performance and fan speed controlled using pulse width modulation (PWM) which significantly reduces noise and vibrations.



Controls with a high IQ for smart homes

Like no other fan convector, the iVECTOR S2 is ideally suited to modern building management systems and can be controlled centrally. Even individual users benefit from the simple-to-use controls. It's also possible in summer to operate in cooling mode and to cool rooms without using an air conditioning system.



Rapid heat-up and easy installation

Due to its low water content the new iVECTOR S2 operates quickly and efficiently. Thanks to its simple design the iVECTOR S2 is very simple to install.



Slimline design

Aesthetically pleasing, the iVECTOR S2's slimline design allows for discreet positioning without compromising performance. Whether surface mounted or recessed the iVECTOR S2 will blend into its environment seamlessly.



Not to be used in high humidity conditions.

iVECTOR S2

VS - Surface mounted models

Wall mounted



- Assembly is to be carried out using the supplied fixings

Ceiling mounted



- Assembly is to be carried out using the supplied fixings
- Horizontally mounted units require a condensate collector tray **C**
- Ceiling mounted units are available as either a Remote Control model† or 0-10V model

Wall mounted with optional pipe covers



- Assembly is to be carried out using the supplied fixings
- The optional decorative pipe covers (non weight-bearing), conceal the connections from the floor **A**

Floor mounted



- Floor mounting feet that anchor the iVECTOR to the ground and conceal connections from the floor **B**
- When installing in front of windows, a corresponding rear metal cover must be used **D**

†Remote control not included, see page 162.

Accessories** - VS

Ref.	Model	Order Code
A	Pipe covers/feet (supplied in pairs) • Covers up supply and return pipes as they enter the unit. • They should be fitted on appliances anchored to the back wall. • These feet should not be used to anchor the iVECTOR S2 to the ground.	VS models VS-WALLPIPECOVER*
B	Floor mounting feet/pipe covers (supplied in pairs) • For anchoring the unit to the ground. • Also covers any hydraulic pipes coming up through the floor.	VS models VS-FLOORBRACKETS*
C	Condensate collector tray Required for horizontally-mounted units in cooling applications. For 2P and 4P versions. Note: The condensate collector tray is included with VSI models.	VS-7 VS-9 VS-11 VS-13 VS-15 VS-7COLLECTOR* VS-9COLLECTOR* VS-11COLLECTOR* VS-13COLLECTOR* VS-15COLLECTOR*
D	Rear metal cover panel for 2P versions, white Cover panel for use when the unit is installed in front of windows. Rear metal cover panel for 4P versions, white Cover panel for use when the unit is installed in front of windows.	VS-7 2-Pipe VS-9 2-Pipe VS-11 2-Pipe VS-13 2-Pipe VS-15 2-Pipe VS-7 4-Pipe VS-9 4-Pipe VS-11 4-Pipe VS-13 4-Pipe VS-15 4-Pipe VS-7COVER2P* VS-9COVER2P* VS-11COVER2P* VS-13COVER2P* VS-15COVER2P* VS-7COVER4P* VS-9COVER4P* VS-11COVER4P* VS-13COVER4P* VS-15COVER4P*
Valve extension 81mm spacer for use with return valve when pipe connection is from the floor.		VS-STREXT*
90° angle EUROKONUS connector Elbow for use with flow valve when pipe connection is through the wall.		VS-ANGEXT*



*Non-stock - made to order only.
**Accessories sold separately.



VS SURFACE MOUNTED MODEL

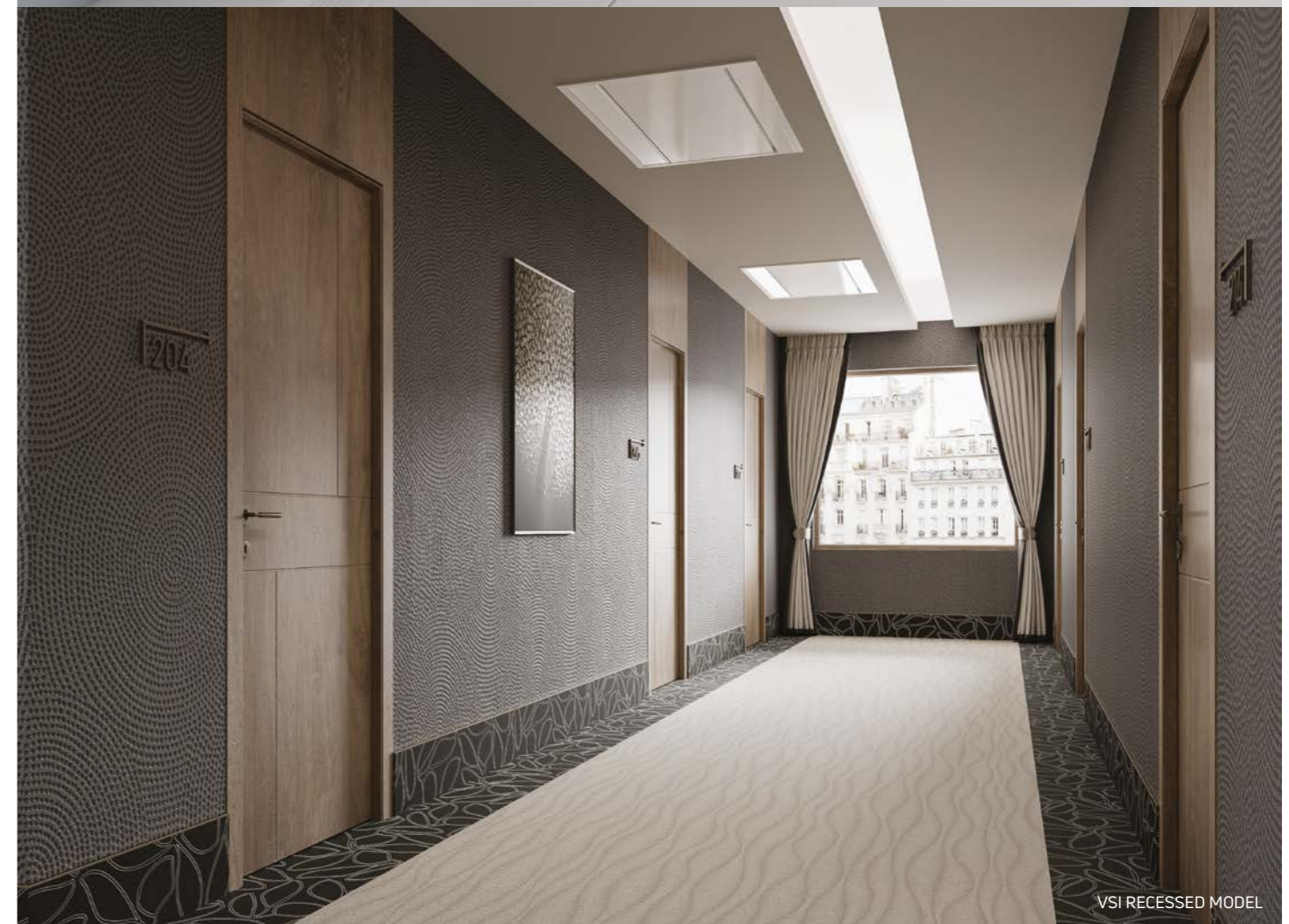

VSI RECESSED MODEL

iVECTOR S2

VSI - Recessed models

Supplied without controls, refer to page 162.



Wall recessed

When installing the iVECTOR S2 in a recessed wall, a metal casing **L** is required to house the iVECTOR and a vertical casing cover **M** for the front face.

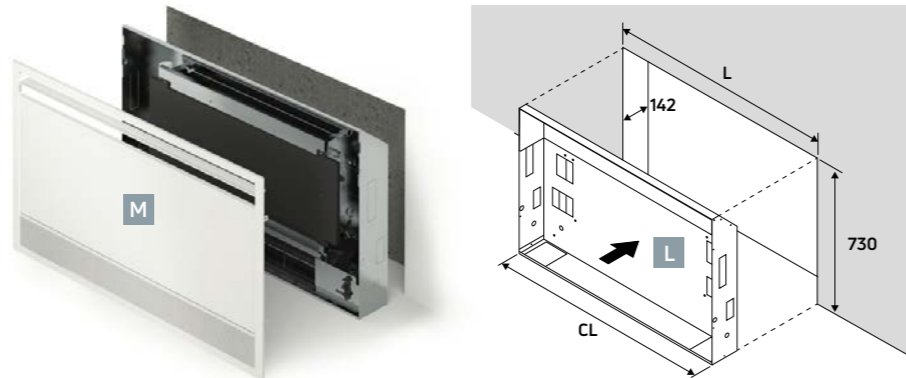

Model	Metal Casing L Dimensions (mm)			Wall Cut-Out Dimensions (mm)		
	Height	Casing Length (CL)	Depth	Height	Length (L)	Depth
VSI-7	725	715	142	730	740	142
VSI-9		915			940	
VSI-11		1115			1140	
VSI-13		1315			1340	
VSI-15		1515			1540	

Ceiling recessed

<p>Installing from a suspended ceiling with both air intake and outlet on bottom</p>	<p>Installing from a suspended ceiling with suction from bottom and horizontal air outlet</p>	<p>Installing in a recessed ceiling with metal casing</p>
<p>Accessories Required</p>	<p>Accessories Required</p>	<p>Accessories Required</p>

NB: The air inlet grilles and air outlet grilles can only be attached to the corresponding air ducts (**E** , **F** and **G**) and not directly to the device!

Accessories** - VSI

Ref.		Model	Order Code
E	Air intake adapter Used with recessed versions when the unit will sit within a false ceiling cavity and the air intake adapter will be exposed.	VSI-7 VSI-9 VSI-11 VSI-13 VSI-15	VSI-7AIRADAPT* VSI-9AIRADAPT* VSI-11AIRADAPT* VSI-13AIRADAPT* VSI-15AIRADAPT*
F	Variable length air flow duct Used with recessed version where outlet needs to be sited away from unit. Min length 302mm, max length 590mm.	VSI-7 VSI-9 VSI-11 VSI-13 VSI-15	VSI-7AIRDUCT* VSI-9AIRDUCT* VSI-11AIRDUCT* VSI-13AIRDUCT* VSI-15AIRDUCT*
G	90° air outlet duct Used with recessed versions where unit will sit in false ceiling cavity and outlet grille will be exposed.	VSI-7 VSI-9 VSI-11 VSI-13 VSI-15	VSI-7DUCT90* VSI-9DUCT90* VSI-11DUCT90* VSI-13DUCT90* VSI-15DUCT90*
H	Air outlet grille straight Used with recessed versions. Grille vanes are straight.	VSI-7 VSI-9 VSI-11 VSI-13 VSI-15	VSI-7OUTSTR* VSI-9OUTSTR* VSI-11OUTSTR* VSI-13OUTSTR* VSI-15OUTSTR*
I	Air inlet grille straight Used with recessed versions. Grille vanes are straight.	VSI-7 VSI-9 VSI-11 VSI-13 VSI-15	VSI-7INSTR* VSI-9INSTR* VSI-11INSTR* VSI-13INSTR* VSI-15INSTR*
J	Air outlet grille curved Used with recessed versions. Grille vanes are curved to direct airflow away from room occupants.	VSI-7 VSI-9 VSI-11 VSI-13 VSI-15	VSI-7OUTCUR* VSI-9OUTCUR* VSI-11OUTCUR* VSI-13OUTCUR* VSI-15OUTCUR*
K	Air inlet grille curved Used with recessed versions. Grille vanes are curved to direct airflow away from room occupants.	VSI-7 VSI-9 VSI-11 VSI-13 VSI-15	VSI-7INCUR* VSI-9INCUR* VSI-11INCUR* VSI-13INCUR* VSI-15INCUR*
L	Metal casing for recessed fan convectors Required for fan convectors with front cover. iVECTOR S2 mounts directly into metal casing. Requires front cover, see page 160.	VSI-7 2-Pipe VSI-9 2-Pipe VSI-11 2-Pipe VSI-13 2-Pipe VSI-15 2-Pipe VSI-7 4-Pipe VSI-9 4-Pipe VSI-11 4-Pipe VSI-13 4-Pipe VSI-15 4-Pipe	VSI-7CASING2P* VSI-9CASING2P* VSI-11CASING2P* VSI-13CASING2P* VSI-15CASING2P* VSI-7CASING4P* VSI-9CASING4P* VSI-11CASING4P* VSI-13CASING4P* VSI-15CASING4P*
M	Vertical casing front cover Vertical casing cover with air intake grille. For use with standard metal casing L .	VSI-7 2-Pipe VSI-9 2-Pipe VSI-11 2-Pipe VSI-13 2-Pipe VSI-15 2-Pipe VSI-7 4-Pipe VSI-9 4-Pipe VSI-11 4-Pipe VSI-13 4-Pipe VSI-15 4-Pipe	VSI-7WALLCVR2P* VSI-9WALLCVR2P* VSI-11WALLCVR2P* VSI-13WALLCVR2P* VSI-15WALLCVR2P* VSI-7WALLCVR4P* VSI-9WALLCVR4P* VSI-11WALLCVR4P* VSI-13WALLCVR4P* VSI-15WALLCVR4P*
N	Ceiling casing front cover Ceiling casing cover with air intake grille. For use with standard metal casing L .	VSI-7 2-Pipe VSI-9 2-Pipe VSI-11 2-Pipe VSI-13 2-Pipe VSI-15 2-Pipe VSI-7 4-Pipe VSI-9 4-Pipe VSI-11 4-Pipe VSI-13 4-Pipe VSI-15 4-Pipe	VSI-7CEILCVR2P* VSI-9CEILCVR2P* VSI-11CEILCVR2P* VSI-13CEILCVR2P* VSI-15CEILCVR2P* VSI-7CEILCVR4P* VSI-9CEILCVR4P* VSI-11CEILCVR4P* VSI-13CEILCVR4P* VSI-15CEILCVR4P*
	Valve extension 81mm spacer for use with return valve when pipe connection is from the floor.		VS-STREXT*
	90° angle EUROKONUS connector Elbow for use with flow valve when pipe connection is through the wall.		VS-ANGEXT*

*Non-stock - made to order only.
**Accessories sold separately.

iVECTOR S2

Control options

Integrated control

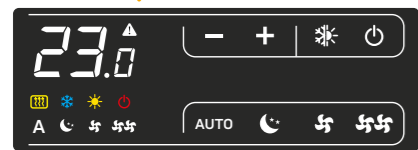

The Integrated Control comes with different control functions:

- **AUTO** - Determines the automatic adjustment of the fan speed as a function of the difference between room temperature and set temperature
- **NIGHT** - Fan speed is limited to a set level and the set temperature is adjusted automatically; reduced in heating mode and increased in cooling mode
- **SILENT** - Fan speed is limited to achieve lower sound levels
- **MAXIMUM FAN SPEED** - Allows rapid achievement of the desired temperature conditions by activating the maximum possible power level

Note: It is not possible to control other units with the Integrated Control.

Remote control†



†Not included with Remote Control iVECTOR S2 - order separately.

With this control option, up to 30 fan convectors can be managed using a single Remote Control.

The connection to the iVECTOR S2 is made using an RS485 Data Cable (not included).

The Remote Control **RC** is available in Black and White.

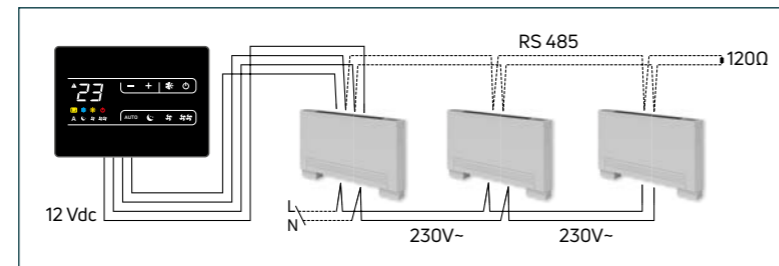

Ref.	Model	Order Code
RC	Remote control Wall-mounted remote control.	S2WALLREMBL* S2WALLREMWH*

*Non-stock - made to order only.

0-10V DC control board





iVECTOR S2 is available with a 0-10V DC control board option which allows the unit to be controlled centrally from a BMS system using a 0-10V analogue input. Suitable external thermostat or building's own BMS system required.





0-10V for Building Management System



iVECTOR S2

General specification

-  **CERTIFICATION**
Produced under a quality management system - ISO 9001:2015, environmental management system - ISO 14001:2015 and Occupational health and safety management system - ISO 45001:2018. Carries the CE mark and conforms to the Low Voltage Directive 2014/35/EU and the EMC Directive 2014/30/EU. Sound levels are tested to EN 23741.
-  **GUARANTEE**
2 year guarantee from date of purchase against manufacturing defects.
-  **COLOUR**
Finished in white (RAL 9003) powder coating.
-  **SYSTEM**
Closed circulation, 2 pipe pump assisted central heating systems.
-  **CONNECTIONS**
2 x 3/4" internal thread connections on 2 pipe versions.
4 x 3/4" internal thread connections on special 4 pipe versions.

-  **AIR VENTS**
Integrated.
-  **OPERATING PRESSURES**
Tested to a pressure of 20 bar.
Working pressure of up to 10 bar.
-  **OPERATING TEMPERATURE**
Maximum 85°C.
-  **ELECTRICAL SUPPLY**
220-240V - 50Hz fused at 3A.
-  **DELIVERY**
2 - 5 working days.
Non-stocked items: 8 - 12 weeks.

For more general information, please see page 264.

Heating and cooling options

2-Pipe model

With a 2-pipe system, fan convectors can normally only be used for either heating or cooling, through either connecting to a heat source or connecting to a chiller. However, if a reverse cycle heat pump is installed in the system, then it is possible for all iVECTOR S2 fan convectors on the system to operate in both heating and cooling modes, depending on which cycle the heat pump is in. A key point to note is that both the heated and chilled water flow through the same 2 pipes, therefore, the entire system must be in either heating or cooling mode.

4-Pipe model

The 4-pipe iVECTOR S2 is capable of providing both heating and cooling to different parts of the same building at the same time. It has two pipes connecting to a heat source and two pipes connecting to a chiller. This feature enables an enhanced indoor comfort solution within the same building.

iVECTOR S2

Technical information

2-Pipe models

Parameter	Metric	Units	Model				
			VS-7 VSI-7	VS-9 VSI-9	VS-11 VSI-11	VS-13 VSI-13	VS-15 VSI-15
Heating/ Cooling	Total cooling (7/12/27°C)	kW med (min - max)*1	0.73 (0.43 - 0.91)	1.36 (0.75 - 2.12)	2.08 (1.15 - 2.81)	2.39 (1.32 - 3.30)	2.57 (1.41 - 3.71)
	Sensible cooling	kW med (min - max)*1	0.51 (0.29 - 0.71)	1.04 (0.59 - 1.54)	1.51 (0.83 - 2.11)	1.84 (1.02 - 2.65)	1.98 (1.05 - 2.90)
	Flow rate	L/h med (min - max)*1	125.3 (73.6 - 156.1)	233.3 (128.7 - 363.8)	356.9 (197.3 - 482.1)	410.1 (226.5 - 556.2)	441.0 (233.3 - 636.6)
	Pressure drop	kPa med (min - max)*1	10.2 (5.7 - 12.1)	4.3 (1.9 - 8.2)	9.9 (2.7 - 17.1)	8.8 (2.5 - 18.0)	11.1 (3.4 - 21.2)
	Heating (75/65/20°C)	kW med (min - max)*1	1.51 (0.81 - 2.21)	3.28 (1.85 - 4.71)	4.79 (2.68 - 6.62)	5.81 (3.29 - 8.42)	6.33 (3.34 - 9.54)
	Flow rate	L/h med (min - max)*1	132.7 (71.5 - 194.7)	289.0 (162.5 - 414.3)	421.5 (236.1 - 582.4)	510.9 (289.7 - 740.9)	556.7 (293.9 - 839.8)
Pressure drop	kPa med (min - max)*1	2.8 (0.9 - 6.5)	3.4 (1.7 - 5.0)	9.3 (3.0 - 16.1)	10.2 (3.4 - 18.2)	8.0 (3.4 - 24.0)	
Hydraulic	Heat exchanger water volume	l	0.47	0.80	1.13	1.46	1.80
	Max. operating pressure	bar	10	10	10	10	10
	Operating temperatures	°C (min - max)	4 - 80	4 - 80	4 - 80	4 - 80	4 - 80
	Pipe S/R connections*2	Inch	Eurocone 3/4"	Eurocone 3/4"	Eurocone 3/4"	Eurocone 3/4"	Eurocone 3/4"
	Condensate drain size	mm	14	14	14	14	14
Air Flow	Airflow*3	m³/h med (min - max)	91 (49 - 146)	210 (124 - 294)	318 (194 - 438)	410 (302 - 567)	479 (364 - 663)
Electrical	Power supply	V/ph/Hz	230/1/50	230/1/50	230/1/50	230/1/50	230/1/50
	Max. power	W	11	19	20	29	33
	Max. power @ min. speed	W	4	4	5	5	5
Acoustics	Sound power	dB(A) med (min - max)*4	44 (33 - 51)	45 (35 - 53)	46 (36 - 54)	47 (36 - 55)	48 (37 - 57)
	Sound pressure*4	dB(A) med (min - max)*4	33 (24 - 41)	34 (25 - 42)	34 (26 - 44)	35 (26 - 46)	38 (28 - 47)

4-Pipe models

Parameter	Metric	Units	Model				
			VS-7 VSI-7	VS-9 VSI-9	VS-11 VSI-11	VS-13 VSI-13	VS-15 VSI-15
Heating/ Cooling	Total cooling (7/12/27°C)	kW med (min - max)*1	0.61 (0.31 - 0.72)	1.13 (0.62 - 1.48)	1.52 (0.79 - 2.06)	1.79 (0.98 - 2.50)	2.18 (1.21 - 3.00)
	Sensible cooling	kW med (min - max)*1	0.45 (0.23 - 0.56)	0.84 (0.46 - 1.15)	1.11 (0.61 - 1.54)	1.41 (0.81 - 1.97)	1.68 (0.93 - 2.31)
	Flow rate	L/h med (min - max)*1	105.4 (52.5 - 124.2)	193.0 (106.3 - 253.5)	260.2 (134.7 - 353.6)	306.4 (168.9 - 428.5)	374.3 (207.8 - 514.2)
	Pressure drop	kPa med (min - max)*1	7.4 (3.9 - 8.4)	5.3 (3.5 - 6.6)	9.7 (4.9 - 13.7)	7.3 (4.0 - 10.8)	6.5 (3.7 - 8.5)
	Heating (75/65/20°C)	kW med (min - max)*1	0.62 (0.38 - 0.71)	1.24 (0.81 - 1.44)	1.74 (1.28 - 2.04)	2.54 (1.76 - 2.90)	2.73 (1.87 - 3.28)
	Flow rate	L/h med (min - max)*1	54.2 (33.6 - 62.6)	108.8 (71.0 - 126.8)	153.5 (112.9 - 179.6)	223.5 (154.7 - 255.3)	240.1 (164.6 - 288.7)
Pressure drop	kPa med (min - max)*1	3.2 (2.7 - 3.4)	3.1 (2.8 - 5.7)	6.8 (6.2 - 9.0)	4.9 (3.8 - 6.1)	4.2 (3.2 - 9.5)	
Hydraulic	Water content cooling	l	0.47	0.80	1.13	1.46	1.80
	Water content heating	l	0.16	0.27	0.38	0.49	0.60
	Max. operating pressure	bar	10	10	10	10	10
	Operating temperatures	°C (min - max)	4 - 80	4 - 80	4 - 80	4 - 80	4 - 80
	Pipe S/R connections*2	Inch	Eurocone 3/4"	Eurocone 3/4"	Eurocone 3/4"	Eurocone 3/4"	Eurocone 3/4"
Condensate drain size	mm	14	14	14	14	14	
Air Flow	Airflow*3	m³/h med (min - max)	91 (46 - 132)	207 (124 - 260)	291 (194 - 370)	367 (247 - 476)	416 (262 - 542)
Electrical	Power supply	V/ph/Hz	230/1/50	230/1/50	230/1/50	230/1/50	230/1/50
	Max. power	W	11	19	20	29	33
	Max. power @ min. speed	W	4	4	4	4	5
Acoustics	Sound power	dB(A) med (min - max)*4	44 (33 - 51)	45 (35 - 53)	46 (36 - 54)	47 (36 - 55)	48 (37 - 57)
	Sound pressure*4	dB(A) med (min - max)*4	33 (24 - 41)	34 (25 - 42)	34 (25 - 44)	35 (26 - 46)	37 (27 - 47)

*1: In Auto mode, values will vary between min-max.
 *2: Supply/return piping is on the left side of the unit. Right side connections also available (MTO only).
 *3: Airflow measured with clean filters.
 *4: Sound pressure measured in semianechoic chamber in compliance with ISO 7779 (distance 3m) - onsite conditions will result in different values.

iVECTOR S2

Technical information (cont...)

FAN CONNECTORS

FAN CONNECTORS

Product dimensions & weights VS - 2-Pipe models

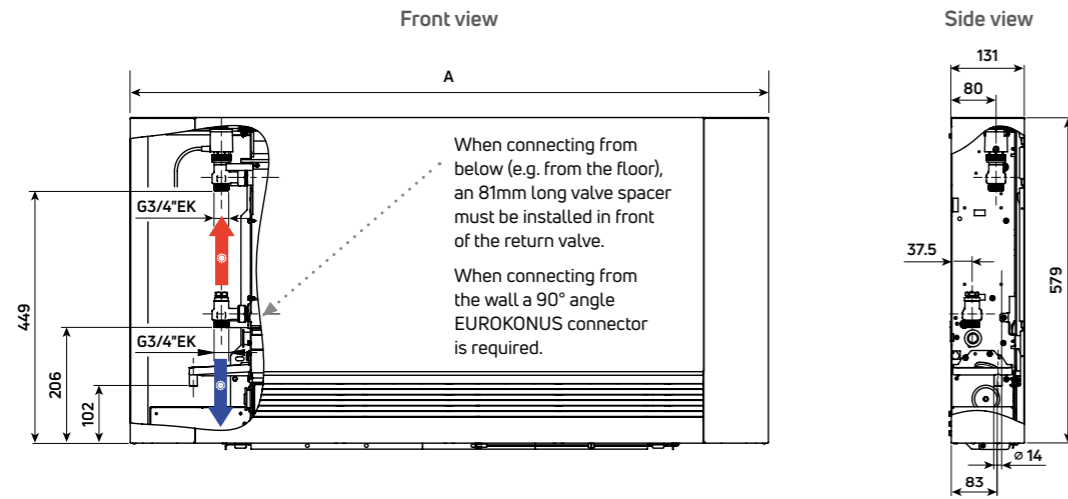

Note: Optional feet are 82mm

	Unit	VS-7	VS-9	VS-11	VS-13	VS-15
Dimension A	mm	735	935	1135	1335	1535
Weight (net)	kg	17	20	23	26	29

Product dimensions & weights VSI - 2-Pipe models

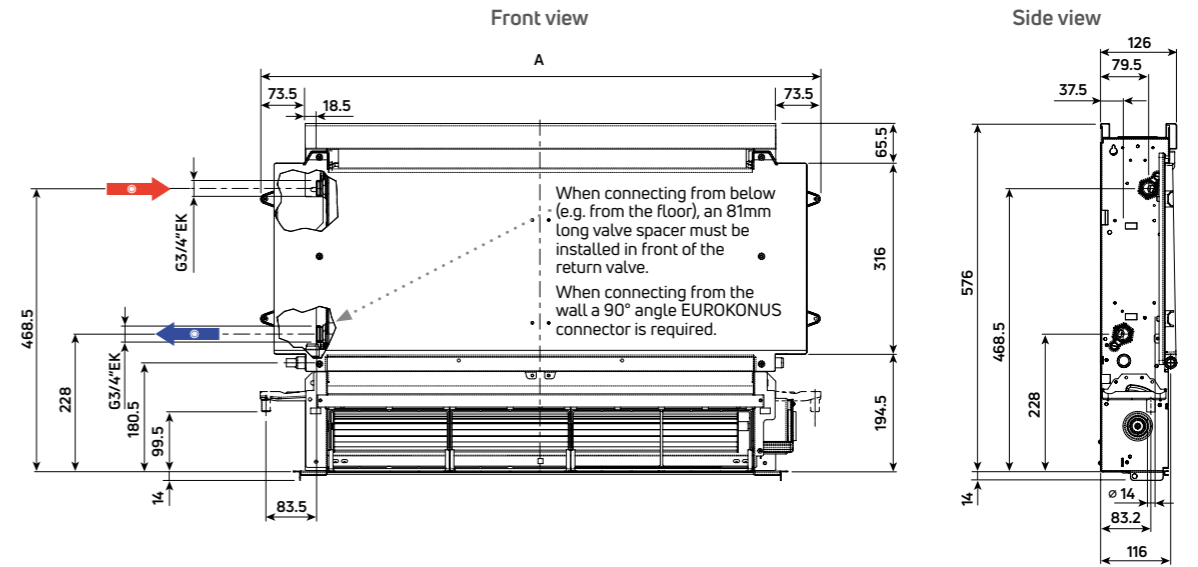

	Unit	VSI-7	VSI-9	VSI-11	VSI-13	VSI-15
Dimension A	mm	525	725	925	1125	1325
Weight (net)	kg	9	12	15	18	21

Product dimensions & weights VS - 4-Pipe models

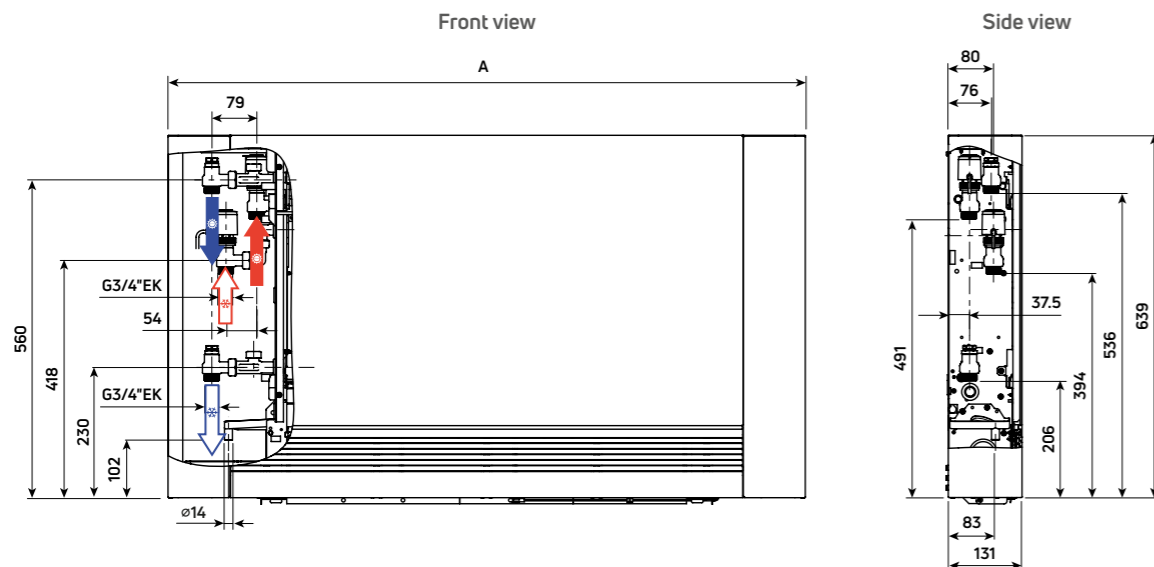

Note: Optional feet are 82mm

	Unit	VS-7	VS-9	VS-11	VS-13	VS-15
Dimension A	mm	735	935	1135	1335	1535
Weight (net)	kg	18	21	25	28	32

Product dimensions & weights VSI - 4-Pipe models

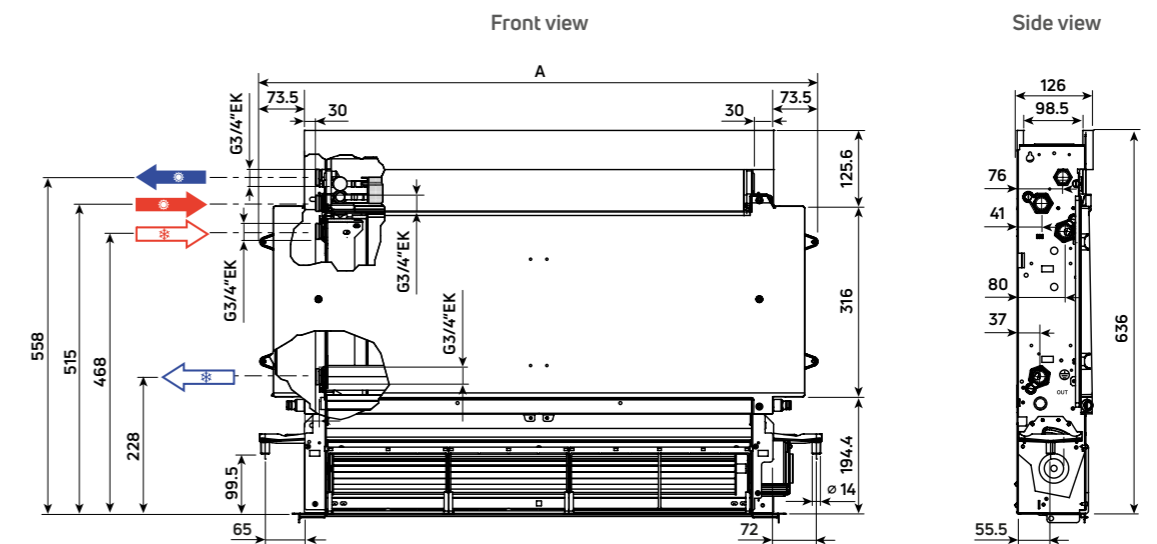

	Unit	VSI-7	VSI-9	VSI-11	VSI-13	VSI-15
Dimension A	mm	525	725	925	1125	1325
Weight (net)	kg	10	13	17	20	24

Note: 2 and 4-pipe recessed unit shown without factory-fitted valves (included).

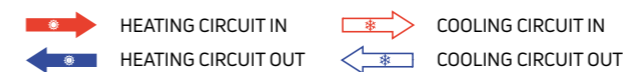
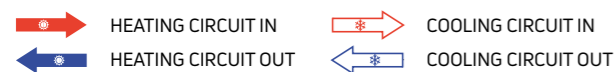

iVECTOR S2

Heat outputs

VS - 2-Pipe models

Unit/Model	Overall Height	Overall Depth	Overall Length	Fan Speed	Heat Output (W)		Cooling Output (W)		Order Code
					ΔT 22.5°C	ΔT 50°C	7/12/27°C		
					45/40/20°C	75/65/20°C	Total	Sensible	
VS-7	579	131	735	Min.	370	810	430	290	INTEGRATED CONTROL VS-7L2IC REMOTE CONTROL VS-7L2RC* 0-10V VS-7L20V*
				Med.	690	1510	730	510	
				Max.	1020	2210	910	710	
VS-9	579	131	935	Min.	820	1850	750	590	INTEGRATED CONTROL VS-9L2IC REMOTE CONTROL VS-9L2RC* 0-10V VS-9L20V*
				Med.	1530	3280	1360	1040	
				Max.	2210	4710	2120	1540	
VS-11	579	131	1135	Min.	1200	2680	1150	830	INTEGRATED CONTROL VS-11L2IC REMOTE CONTROL VS-11L2RC* 0-10V VS-11L20V*
				Med.	2160	4790	2080	1510	
				Max.	3020	6620	2810	2110	
VS-13	579	131	1335	Min.	1470	3290	1320	1020	INTEGRATED CONTROL VS-13L2IC REMOTE CONTROL VS-13L2RC* 0-10V VS-13L20V*
				Med.	2590	5810	2390	1840	
				Max.	3810	8420	3300	2650	
VS-15	579	131	1535	Min.	1940	4340	1410	1070	INTEGRATED CONTROL VS-15L2IC REMOTE CONTROL VS-15L2RC* 0-10V VS-15L20V*
				Med.	2820	6330	2570	1980	
				Max.	4320	9540	3710	2900	

- The standard VS 2-pipe 'INTEGRATED CONTROL' variant has a factory-fitted control unit on the iVECTOR.
- The VS 2-pipe 'REMOTE CONTROL' variant is supplied without a control unit, which can be ordered separately as an accessory, see [RC](#) page 162.
- For use with BMS systems or a compatible thermostat, the '0-10V' variant should be used.
- All VS 2-pipe variants are equipped with an automatic, electric 2-way valve set with ¾" Eurocone connections in 2-pipe design.

VS - 4-Pipe models

Unit/Model	Overall Height	Overall Depth	Overall Length	Fan Speed	Heat Output (W)		Cooling Output (W)		Order Code
					ΔT 22.5°C	ΔT 50°C	7/12/27°C		
					45/40/20°C	75/65/20°C	Total	Sensible	
VS-7	639	131	735	Min.	170	380	310	230	INTEGRATED CONTROL VS-7L4IC* REMOTE CONTROL VS-7L4RC* 0-10V VS-7L40V*
				Med.	240	620	610	450	
				Max.	290	710	720	560	
VS-9	639	131	935	Min.	350	810	630	460	INTEGRATED CONTROL VS-9L4IC* REMOTE CONTROL VS-9L4RC* 0-10V VS-9L40V*
				Med.	520	1240	1130	840	
				Max.	610	1440	1480	1150	
VS-11	639	131	1135	Min.	520	1280	790	610	INTEGRATED CONTROL VS-11L4IC* REMOTE CONTROL VS-11L4RC* 0-10V VS-11L40V*
				Med.	700	1740	1520	1110	
				Max.	820	2040	2060	1540	
VS-13	639	131	1335	Min.	590	1760	980	810	INTEGRATED CONTROL VS-13L4IC* REMOTE CONTROL VS-13L4RC* 0-10V VS-13L40V*
				Med.	860	2540	1790	1410	
				Max.	1000	2900	2500	1970	
VS-15	639	131	1535	Min.	630	1870	1210	930	INTEGRATED CONTROL VS-15L4IC* REMOTE CONTROL VS-15L4RC* 0-10V VS-15L40V*
				Med.	1150	2730	2180	1680	
				Max.	1390	3280	3000	2310	

- The standard VS 4-pipe 'INTEGRATED CONTROL' variant has a factory-fitted control unit on the iVECTOR.
- The VS 4-pipe 'REMOTE CONTROL' variant is supplied without a control unit, which can be ordered separately as an accessory, see [RC](#) page 162.
- For use with BMS systems or a compatible thermostat, the '0-10V' variant should be used.
- All VS 4-pipe variants are equipped with an automatic, electric 2-way valve set with ¾" Eurocone connections in 4-pipe design.

VSI - 2-Pipe models

Unit/Model	Overall Height	Overall Depth	Overall Length	Fan Speed	Heat Output (W)		Cooling Output (W)		Order Code
					ΔT 22.5°C	ΔT 50°C	7/12/27°C		
					45/40/20°C	75/65/20°C	Total	Sensible	
VSI-7	576	126	525	Min.	370	810	430	290	REMOTE CONTROL VS-7L2RC* 0-10V VS-7L20V*
				Med.	690	1510	730	510	
				Max.	1020	2210	910	710	
VSI-9	576	126	725	Min.	820	1850	750	590	REMOTE CONTROL VS-9L2RC* 0-10V VS-9L20V*
				Med.	1530	3280	1360	1040	
				Max.	2210	4710	2120	1540	
VSI-11	576	126	925	Min.	1200	2680	1150	830	REMOTE CONTROL VS-11L2RC* 0-10V VS-11L20V*
				Med.	2160	4790	2080	1510	
				Max.	3020	6620	2810	2110	
VSI-13	576	126	1125	Min.	1470	3290	1320	1020	REMOTE CONTROL VS-13L2RC* 0-10V VS-13L20V*
				Med.	2590	5810	2390	1840	
				Max.	3810	8420	3300	2650	
VSI-15	576	126	1325	Min.	1940	4340	1410	1070	REMOTE CONTROL VS-15L2RC* 0-10V VS-15L20V*
				Med.	2820	6330	2570	1980	
				Max.	4320	9540	3710	2900	

- All VSI 2-pipe variants include a factory-installed PCB control board, an automatic, electric 2-way valve set with ¾" Eurocone connections in 2-pipe design.
- The Remote Control variant is available to connect to the wall-mounted Remote Control which can be ordered separately as an accessory, see [RC](#) page 162.
- For use with BMS systems or a compatible thermostat, select the 0-10V variant.

VSI - 4-Pipe models

Unit/Model	Overall Height	Overall Depth	Overall Length	Fan Speed	Heat Output (W)		Cooling Output (W)		Order Code
					ΔT 22.5°C	ΔT 50°C	7/12/27°C		
					45/40/20°C	75/65/20°C	Total	Sensible	
VSI-7	636	126	525	Min.	170	380	310	230	REMOTE CONTROL VS-7L4RC* 0-10V VS-7L40V*
				Med.	240	620	610	450	
				Max.	290	710	720	560	
VSI-9	636	126	725	Min.	350	810	630	460	REMOTE CONTROL VS-9L4RC* 0-10V VS-9L40V*
				Med.	520	1240	1130	840	
				Max.	610	1440	1480	1150	
VSI-11	636	126	925	Min.	520	1280	790	610	REMOTE CONTROL VS-11L4RC* 0-10V VS-11L40V*
				Med.	700	1740	1520	1110	
				Max.	820	2040	2060	1540	
VSI-13	636	126	1125	Min.	590	1760	980	810	REMOTE CONTROL VS-13L4RC* 0-10V VS-13L40V*
				Med.	860	2540	1790	1410	
				Max.	1000	2900	2500	1970	
VSI-15	636	126	1325	Min.	630	1870	1210	930	REMOTE CONTROL VS-15L4RC* 0-10V VS-15L40V*
				Med.	1150	2730	2180	1680	
				Max.	1390	3280	3000	2310	

- All VSI 4-pipe variants include a factory-installed PCB control board, an automatic, electric 4-way valve set with ¾" Eurocone connections in 4-pipe design.
- The Remote Control variant is available to connect to the wall-mounted Remote Control which can be ordered separately as an accessory, see [RC](#) page 162.
- For use with BMS systems or a compatible thermostat, select the 0-10V variant.

*Non-stock - made to order only.



Underfloor heating

Underfloor heating has been gaining popularity and is widely acknowledged as one of the most effective and efficient methods of heating. It has become the fastest growing market for both domestic and commercial heating sectors. As one of Europe's leading names in heating technology, MYSON FLOORTEC underfloor heating is at the forefront of the underfloor revolution. In addition to our manufacturing and technical expertise, we provide full planning, design and supply services to help you achieve your perfect home.

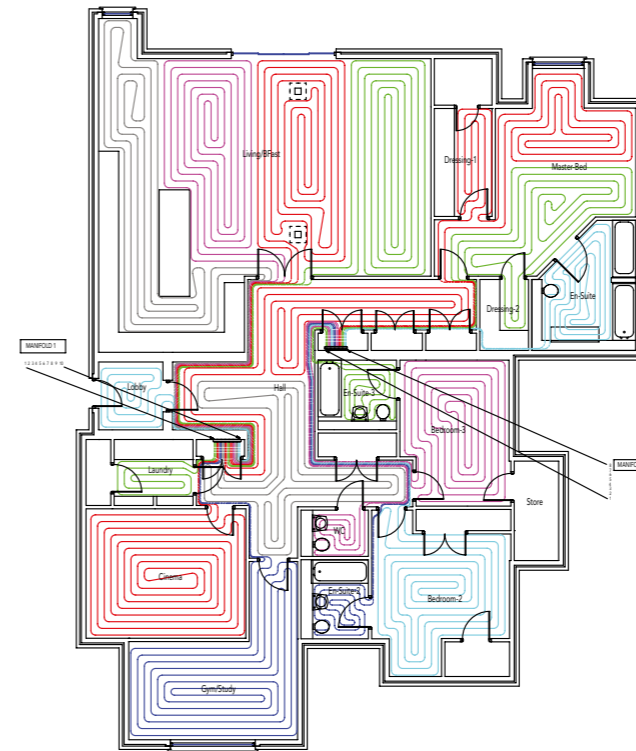

How it works

MYSON FLOORTEC underfloor heating works by heating your home from the floor upwards. This form of radiant heating is different to the convected heat provided by radiators, which works by drawing cold air across your floor, heating it and then convecting it upwards.

The main advantage of MYSON FLOORTEC underfloor heating is its high level of performance. Radiant heat means that the warmth is concentrated where you need it most. You'll enjoy uniform heat, with no cold spots or draughts, and it's perfect for comfort - you won't get cold feet and you will keep a cool head.

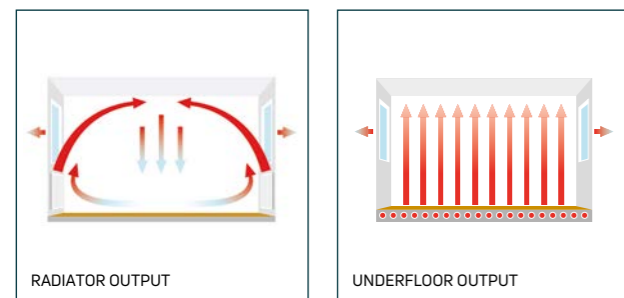

Quotation service

MYSON FLOORTEC underfloor heating pride ourselves on our market leading service. We offer a free 48hr quotation service that couldn't be easier. We do all the calculations for you and prepare a detailed quotation. All you need to do is send us your architect's floor plans or measurements and we'll take care of the rest.

E-mail your drawings to: underfloor@myson.co.uk

Post your drawings to:

Myson FLOORTEC Underfloor Heating
Eastern Avenue
Team Valley
Gateshead
Tyne & Wear
NE11 0PG

Alternatively you can call us on **0330 041 5474**

Design service

MYSON FLOORTEC underfloor heating provide a full design service, tailored to individual requirements. Our unique design will relate to your project, however large or small, and will make the installation of our underfloor heating even easier.

Our complete design service starts with an assessment of the customer's needs. We use architects plans to assess heat loss requirements and produce a computerised design of the most efficient layout.

This design service is completely free and carried out by our technical experts, who have years of experience in designing underfloor heating systems. As we are the only

total solutions provider, we can also offer unbiased advice about other forms of heating. For example, it may be more effective to combine underfloor heating with radiators or other heat emitters. If this is the case, then we will provide you with a fully integrated design that includes both underfloor heating and radiators.

All we need to produce your designs are the full architectural drawings. All our drawings are advisory only based on our years of heating expertise.



Training

MYSON FLOORTEC underfloor heating offers free training workshops for installers or developers to show how easy it is to install our underfloor heating systems.

Training takes place at our head office in Gateshead and is carried out by our technical experts, who have years of experience designing and installing underfloor heating systems.

To find out when the next training session is, call **0330 041 5474** or e-mail underfloor@myson.co.uk

After sales service

Our first class service doesn't stop once we've sold our systems. We want our customers to enjoy the benefits of our systems to the full, and as such we offer a special ServicePlus after sales service.

Our ServicePlus technical support team are available to help you get the most out of our products. Our helpful team of technical advisors are always on hand to answer any questions regarding MYSON FLOORTEC underfloor heating.

We offer:

- Swift and practical advice from our experts
- Comprehensive customer service
- Free training at our dedicated UK training facility
- Special onsite support service from our experienced sales team
- Shared knowledge and expertise
- Free support for all partners

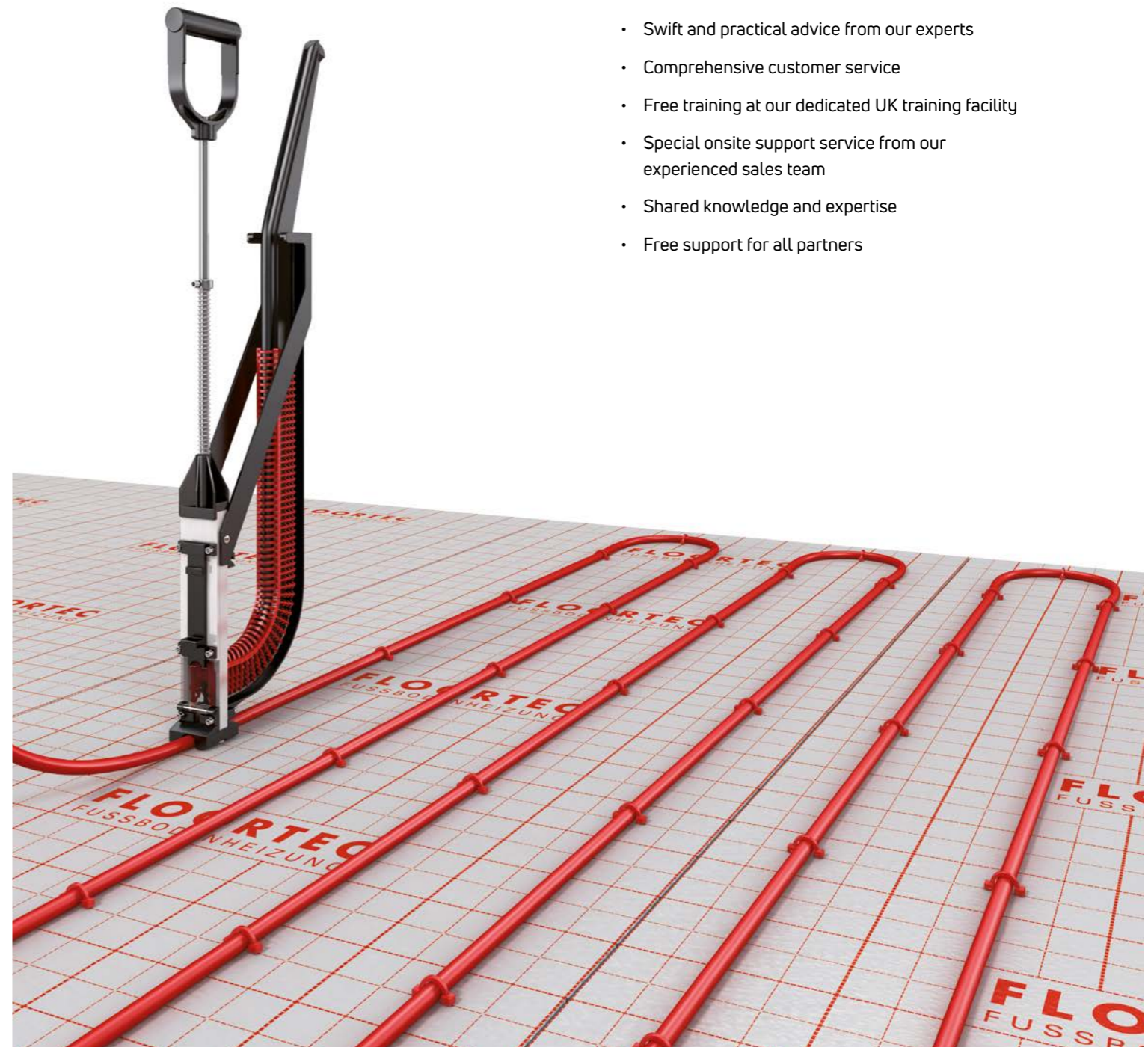

Quality guaranteed

Every component of a MYSON FLOORTEC Complete Underfloor Heating System has undergone thousands of test cycles. Our underfloor heating systems are regularly assessed for quality by independent international institutions and consistently achieve top marks and quality certificates.

- Guaranteed for all operating conditions
- MYSON is a Member of BEAMA
- All electrical components carry a 2 year warranty from date of installation
- MYSON FLOORTEC offer a comprehensive 10 year pipe warranty
- The Premium Pump Pack comes complete with a 2 year warranty

Complete System Guarantee*

MYSON FLOORTEC underfloor heating also offer a 10 year Complete System Guarantee* that promotes the advantages of both tried and tested component compatibility and correct system design. We are confident that, when installed correctly**, our systems will perform to the highest standards, so eliminating unnecessary problems. Buy a bespoke system from MYSON and our Complete System Guarantee means you will benefit from complete peace of mind.



*Terms and conditions apply. Contact our Underfloor Heating Team for further information.

**MYSON FLOORTEC cannot be held responsible for problems arising from poorly installed systems. All installations must be fitted in accordance with the CIBSE Underfloor Heating Design and Installation Guide 2004.



FIXING SYSTEMS

MYSON FLOORTEC underfloor heating offer a full and comprehensive range of fixing systems for all floor types. Our systems are suitable for any project, and include solutions for solid, suspended, floating and retrofit floors.

SOLID FLOORS are a common type of floor system and are cost effective for underfloor heating. Underfloor heating pipes are embedded into concrete or screed.

SUSPENDED FLOORS include joisted floors with conventional joists supported on end walls of sleeper walls as well as solid floors with battens fixed to the floor.

FLOATING FLOOR structures are ideal for underfloor heating as they have a low thermal mass and therefore a rapid response to changes in temperature.

RETROFIT FLOORS allow you to install underfloor heating in older and existing properties without the need for expensive excavation.

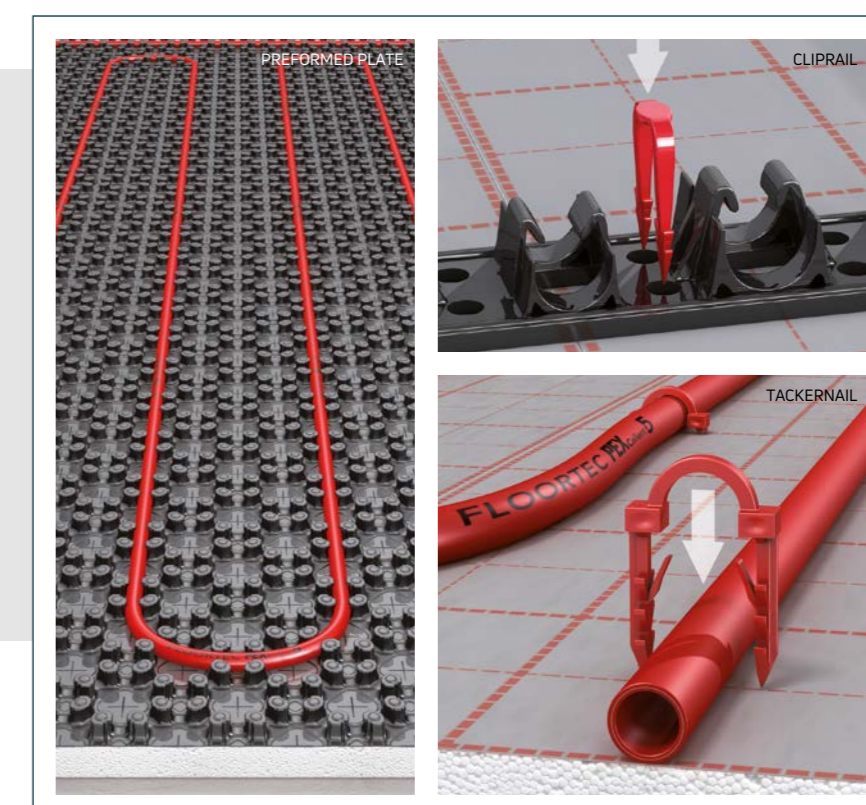

TACKERNAIL

MYSON FLOORTEC underfloor heating Tackernails are exclusive to MYSON, and are the strongest nail solution available. The Tackernail system is suitable for solid floor types.



CLIPRAIL

Cliprail systems are for use on solid floor types. The Cliprails are designed to attach the MYSON FLOORTEC underfloor heating pipework to floor insulation (supplied by others) using the adhesive and Cliprail pins supplied.



The Tackernail is made entirely out of plastic so there is no clogging from sticking tape. It also has more barbs, so there is no worry about nails lifting. The pipe is positioned in place and the Tackernail is fixed over the pipe using a MYSON FLOORTEC Tackertool. The Tackertool is specifically designed to work with our Tackernails for easy and efficient operation. It can be purchased or rented from MYSON FLOORTEC.

Tackernail and Tackertool have been designed with the installer in mind, as it is a fast and effective method of anchoring the MYSON FLOORTEC underfloor heating pipework. It is also very flexible allowing both spiral and serpentine laying patterns.

Please note: No floor insulation is supplied with this fixing system.

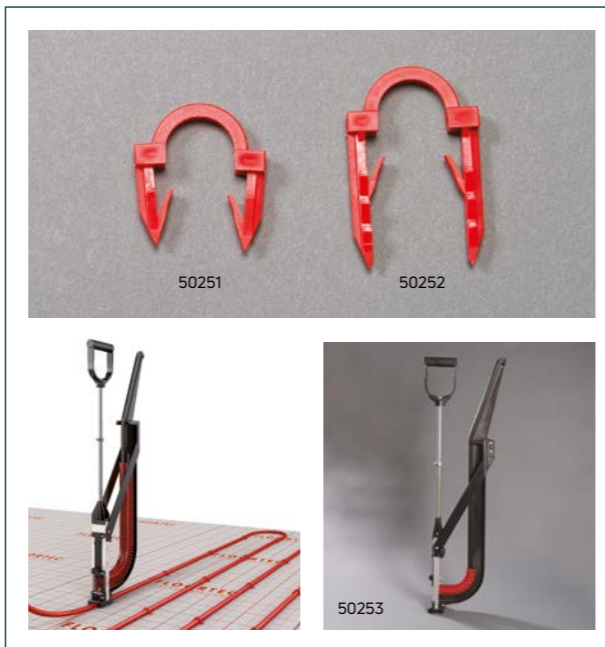

The Cliprail consists of a robust, u-shaped channel that is 1m in length, with fixing positions every 50mm.

This is a fast and cost effective method of installing underfloor heating and is suitable for both traditional and liquid screeds. The pipe is installed in a serpentine laying pattern.

Please note: No floor insulation is supplied with this fixing system.

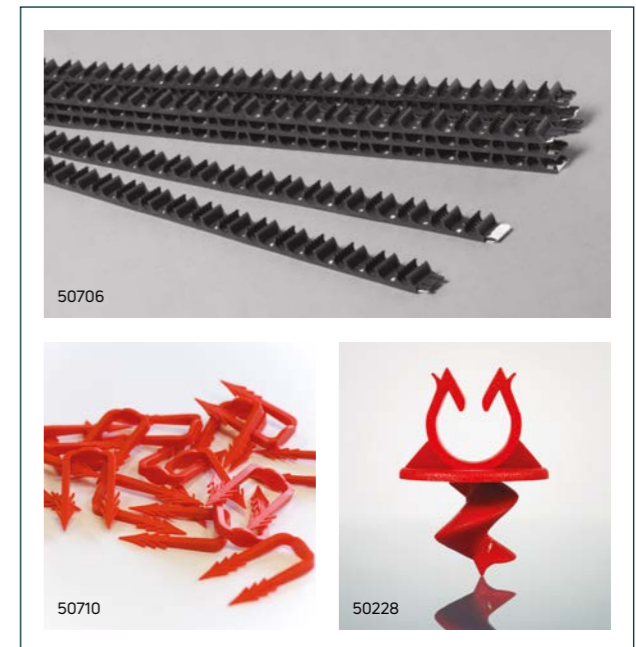

 **DELIVERY**
2 - 5 working days.

Description	Order Code
3D Medium (42mm) Tackernail* (Box of 400)	50251
3D Long (58mm) Tackernail* (Box of 400)	50252
3D Tackertool UNI	50253
Red Insulated Pipe Sleeve (20m Roll)	50069
Flexible Pipe Cover (400mm Length)	50078
Expansion Profile (2m)	50076
Expansion Joint Strip (2m)	50077
Border Insulation (30m Roll)	50220
Screed Tape (75m Roll)	50226
25mm PS20 Flatpack Insulation (10m ²)	50325

*Tackernails are only compatible with the 3D Tackertool UNI.

 **DELIVERY**
2 - 5 working days.

Description	Order Code
17mm Black Cliprail (1m length)	50706
50mm Red Cliprail Pins (Pack of 500)	50710
Anchor Clips	50228
Red Insulated Pipe Sleeve (10m Roll)	50069
Flexible Pipe Cover (400mm Length)	50078
Expansion Profile (2m)	50076
Expansion Joint Strip (2m)	50077
Border Insulation (30m Roll)	50220
Screed Tape (75m Roll)	50226



PREFORMED PLATE

Preformed Plate is a fast and effective fixing system and is ideal for single person installations. It is suitable for solid floor types.



It is a castellated fixing system that comprises of an expanded 11mm polystyrene insulation base with raised burls that are designed to firmly grip the MYSON FLOORTEC underfloor heating pipe. The pipe is fixed easily into the desired pattern by lightly pressing with your foot.

It is suitable for 14 - 17mm pipework and is very flexible, allowing both spiral and serpentine laying patterns.

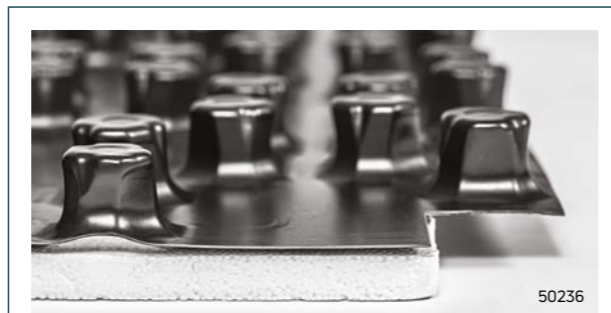

 **DELIVERY**
2 - 5 working days.

Description	Order Code
Preformed Plate 14 to 17mm Pipe (1500 x 800mm)	50236
Foam Perimeter Tube (100m)	50237
Red Insulated Pipe Sleeve (10m Roll)	50069
Flexible Pipe Cover (400mm Length)	50078
Expansion Profile (2m)	50076
Expansion Joint Strip (2m)	50077
Border Insulation (30m Roll)	50220



NAKED PREFORMED PLATE

Naked Preformed Plate is a fast and effective fixing system and is ideal for single person installations. It is suitable for solid floor types.



It excludes the 11mm polystyrene insulation that comes with Preformed Plate and is a cost-effective alternative. It is more streamlined and therefore ideal for areas where space is critical. It is a castellated fixing system with raised burls that are designed to firmly grip the MYSON FLOORTEC underfloor heating pipe. The pipe is fixed easily into the desired pattern by lightly pressing with your foot.

It is suitable for 14 - 17mm pipework and is very flexible, allowing both spiral and serpentine laying patterns.



 **DELIVERY**
2 - 5 working days.

Description	Order Code
Naked Preformed Plate 14 to 17mm Pipe (1440 x 840mm)	50537
Fixing Dowel	50538
Red Insulated Pipe Sleeve (20m Roll)	50069
Flexible Pipe Cover (400mm Length)	50078
Expansion Profile (2m)	50076
Expansion Joint Strip (2m)	50077
Border Insulation (30m Roll)	50220
Foam Perimeter Tube (100m)	50237

MICROPLATE

Suitable for multiple build types, achieving the appearance, functionality and performance of a solid floor.



The MicroPlate panel can easily be installed by a single person. MicroPlate is a secure pipe holder and becomes an integral part of the floor structure once latex screed has been applied, making the plate resistant to impact. Ultra low lift system at only 15mm utilising a 12mm pipe.

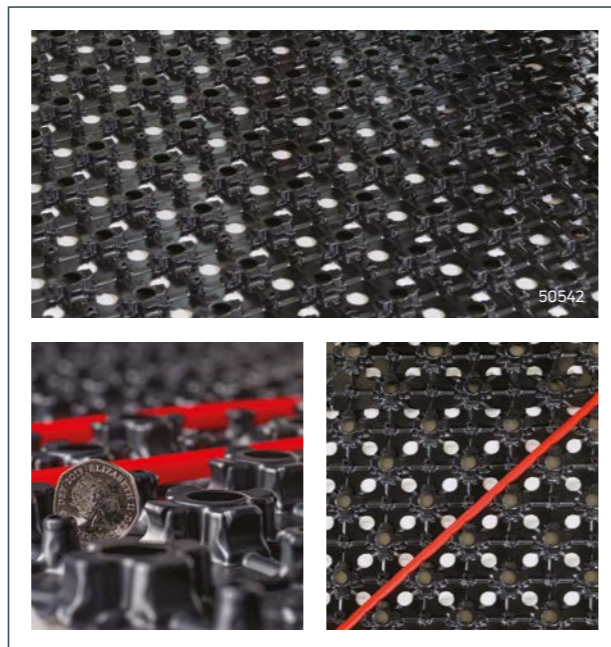

MICROPLATE WITH INSULATION BELOW SLAB

DELIVERY
2 - 5 working days.

Description	Order Code
15mm MicroPlate panel with adhesive (1000 x 600mm)	50542

TACKER

Tacker fixing system is suitable for solid floor types and incorporates all the advantages of our Tackernail fixing system.



It is supplied with 25mm insulation with a webbing foil bonded to the surface. This foil acts as a protective layer, but also helps to assist the positioning of the pipework with a handy 50mm grid marked on. The pipe is then positioned in place using our exclusive Tackernails and Tackertool. It is also very flexible allowing both spiral and serpentine laying patterns.

The Tackernail is made entirely out of plastic so there is no clogging from sticking tape. It also has more barbs, so there is no worry about nails lifting. The Tackertool is specifically designed to work with our Tackernails for easy and efficient operation. It can be purchased or rented from MYSON FLOORTEC.

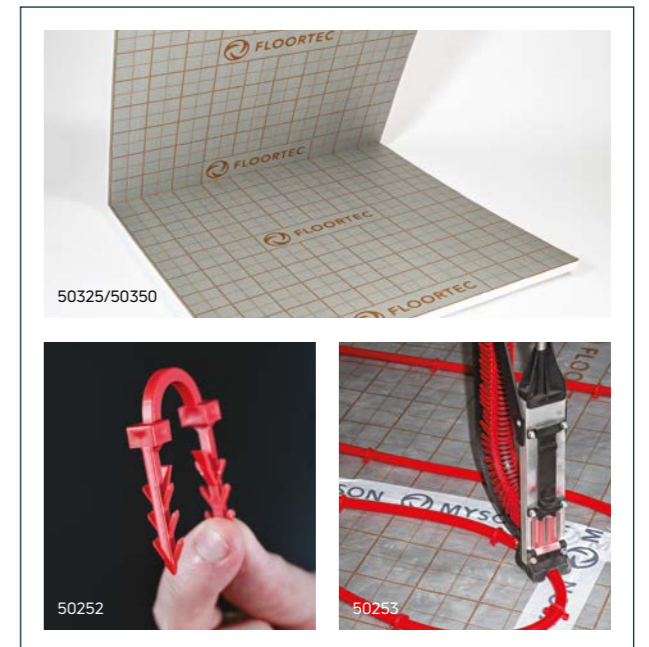

DELIVERY
2 - 5 working days.

Description	Order Code
25mm PS20 Flatpack Insulation (10m ²)	50325
3D Medium (42mm) Tackernail* (Box of 400)	50251
3D Long (58mm) Tackernail* (Box of 400)	50252
3D Tackertool UNI	50253
Red Insulated Pipe Sleeve (20m Roll)	50069
Flexible Pipe Cover (400mm Length)	50078
Expansion Profile (2m)	50076
Expansion Joint Strip (2m)	50077
Border Insulation (30m Roll)	50220
Screed Tape (75m Roll)	50226

*Tackernails are only compatible with the 3D Tackertool UNI.

PLATED

Suspended floor systems include both joisted floors with conventional joists supported on end walls of sleeper walls, as well as solid floors with battens fixed to the floor.



50550

The underfloor heating system consists of aluminium diffusion plates fitted between joists or battens. These are grooved to accept the underfloor heating pipework. The aluminium plate is used for its excellent thermal conduction as well as its low weight. It is suitable for 16 and 17mm pipework.



50548

50548

 **DELIVERY**
2 - 5 working days.

Description	Order Code
Double Floor Plate (1000 x 388mm)	50550
3 Channel Floor Plate (1000 x 388mm)	50548
3 Channel Floor Plate (1000 x 588mm)	50553

SUBPLATE

MYSON SUBPLATE is suitable for use on both traditional and composite joists and is ideal for situations where the floor coverings are already in place.



50555

This system consists of an aluminium diffusion plate, fitted on the underside of the floor between the joists.

SUBPLATE is available in two width sizes, 150mm and 250mm, giving pipe centre flexibility depending on your joist configuration. For advice on using this system in alternative configurations, please speak with our technical department on **0330 041 5474**.

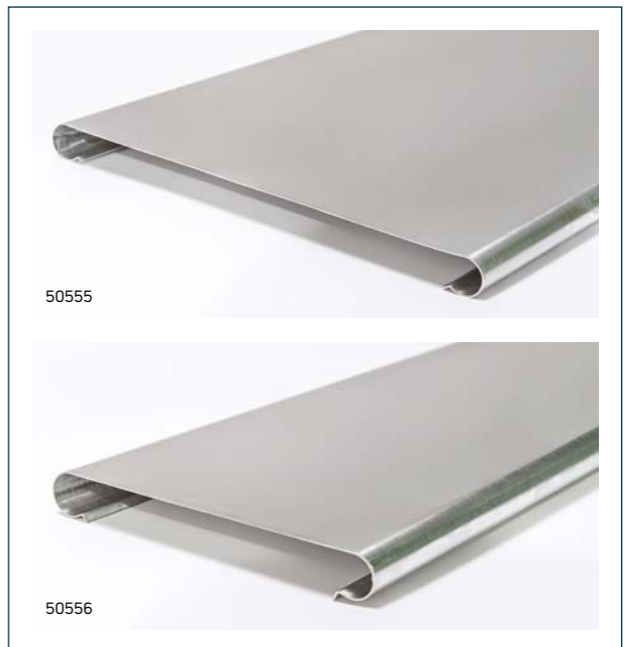

50555

50556

 **DELIVERY**
2 - 5 working days.

Description	Order Code
SUBPLATE (250 x 1000mm)	50555
SUBPLATE (150 x 1000mm)	50556

FLOATING FLOOR

The MYSON FLOORTEC floating floor system has been uniquely developed to meet the increasing demand for this type of flooring structure.



Floating floor systems have a low thermal mass and consequently have a swift response time to changes in temperature. Floating floors also reduce the overall load on the building, minimising the weight of the floor compared to the other floor systems. It is suitable for 16mm multi-layer pipework only.

The grooves are designed to accept MYSON FLOORTEC preformed aluminium diffusion plates, which spread the heat laterally across the floor from the heating pipework.

Technical data

	30/40/50mm Panel
Nominal Density (Kg/m ³)	30
Thermal Conductivity (W/mK)	0.029
Minimum Compressive Strength (kPa)	200
Long Term Static Load (kPa)	Design Loads* 40
Occasional Loading (kPa)	Design Loads* 66
Water Vapour Resistance (MNs/gm)	480
Moisture Absorption (by vol.)	0.3%
Continuous Service Temp Limits (°C)	-50 to +75

*Design loads by calculated methods (BBA)

DELIVERY
2 - 5 working days.

Description	Order Code
30mm XPS Floating Floor Panel (2400 x 1200mm)	50545
40mm XPS Floating Floor Panel (2400 x 1200mm)	50546
50mm XPS Floating Floor Panel (2400 x 1200mm)	50547
Flat Floor Plate (1000 x 400mm)	50552
Double Floor Plate (1000 x 388mm)	50550
Compact Pipe De-Coiler	50018
Hot Cutter	50008
Replacement Hot Cutter Blade	50007



MICROBOARD

MICROBOARD, from MYSON FLOORTEC, is a retrofit, low profile underfloor heating system. It can be installed over an existing floor, or be used as part of a new build project, making it our most flexible system yet.

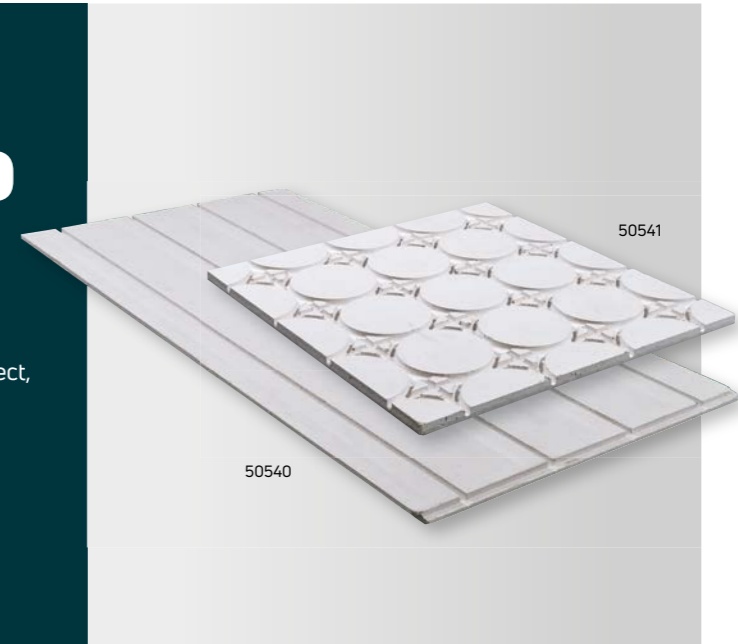

At only 18mm in depth it allows for underfloor heating to be easily installed into older and existing properties without the need for expensive and disruptive excavation.

It is available in two panel types, straight and return, and our 12mm PEXcellent5 pipe is easily laid into the panels.

Technical data

	18mm Board
Density (Kg/m ³)	1150±50
Thermal Conductivity (W/mK)	0.32
Minimum Compressive Strength (kPa / N/mm ²)	8500 / 8.5
Airborne Sound (Rw)	28dB
Impact Sound (Ln,w)	86dB
Specific Heat Capacity (kJ/kgK)	1.1



DELIVERY
2 - 5 working days.

Description	Order Code
Straight Board (1200 x 600 x 18mm)	50540
Return Board (600 x 600 x 18mm)	50541

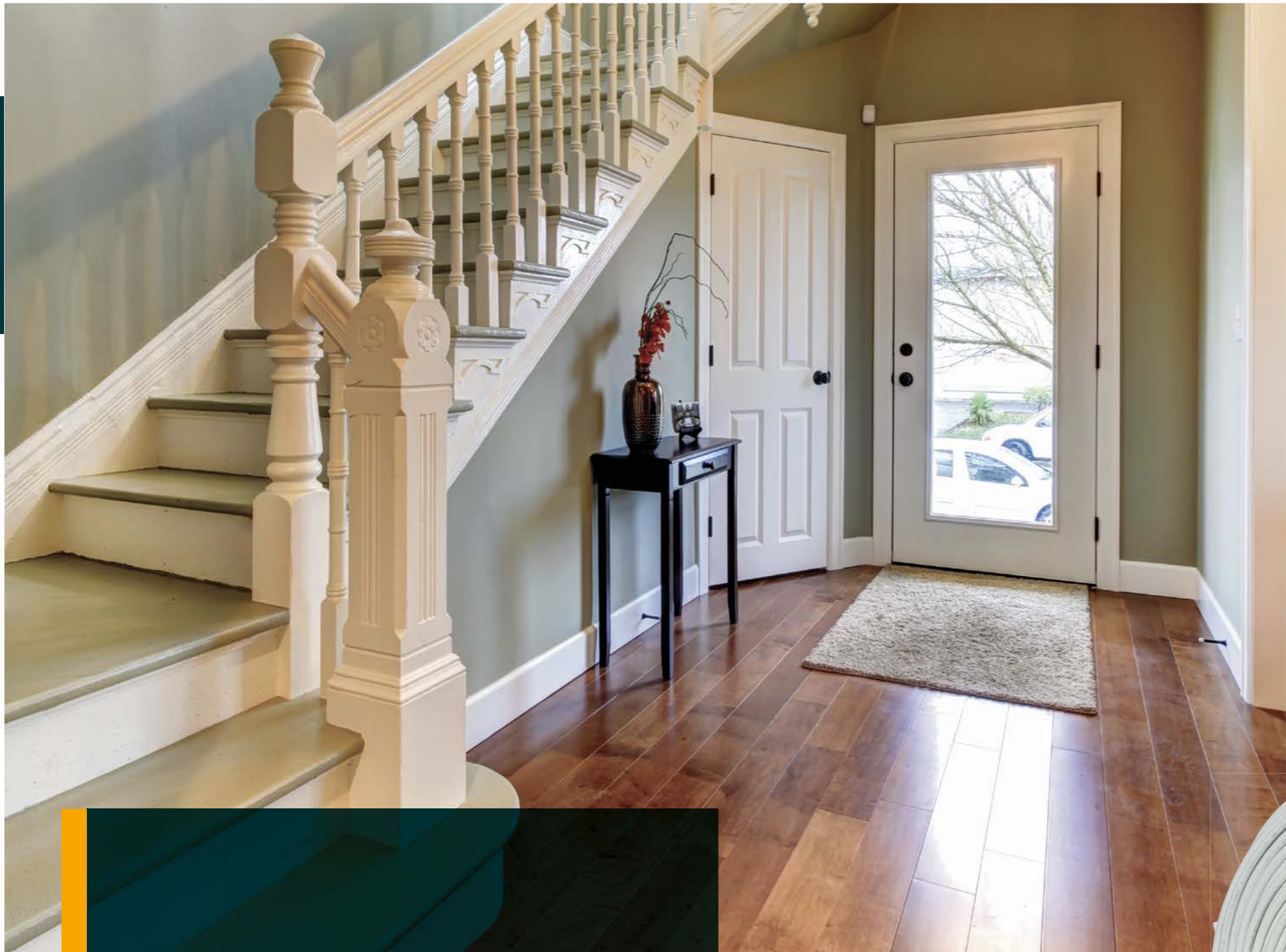

MYSON has been manufacturing FLOORTEC underfloor heating pipe since 1974. Our plant, based in Germany, combines all the advantages of precision German engineering with our own unrivalled expertise in the field of heating.

MYSON produce a full range of quality FLOORTEC pipework that is suitable for all of our fixing systems. Our pipe is environmentally friendly and quality guaranteed and conforms to all European quality standards, being tested to DIN4726 and BS7291-1:2001. It comes as part of our 10 year Complete System Guarantee, so you can be confident you are installing the best pipe available on the market.

We offer two types of pipe, 12, 17 and 20mm PEXcellent5 and 16mm multi-layer pipe.

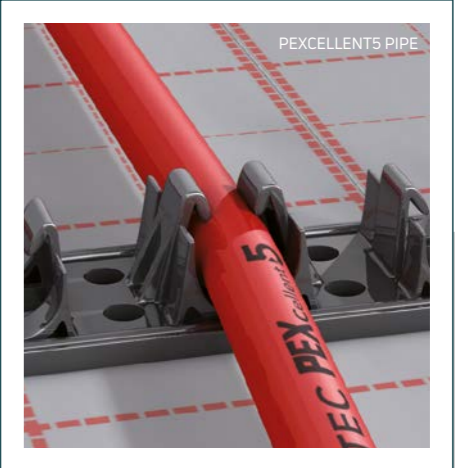

MULTI-LAYER PIPE





PIPE

PEXCELLENT5

MYSON FLOORTEC PEXcellent5 underfloor heating pipe is a polyethylene pipe with five layers, which includes an integral oxygen barrier.

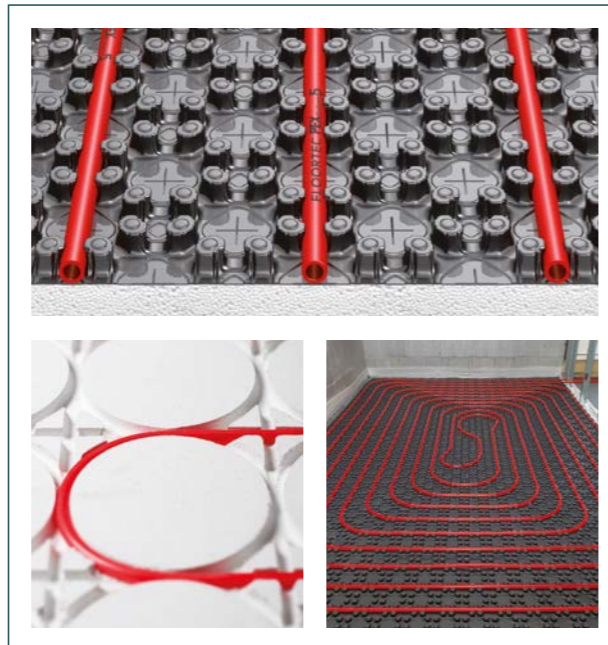

It is available in 12mm, 17mm and 20mm diameters and is compatible with most MYSON FLOORTEC heating systems, including MICROBOARD, our low-profile heating system. It is environmentally friendly and is produced with no chemical additives in either the production or disposal processes. It is quality guaranteed for 10 years and conforms to DIN4726 and BS7291-1:2001.



 **DELIVERY**
2 - 5 working days.

Description	Order Code
PEXcellent5 pipe 17 x 2mm (80m Coil)	54046
PEXcellent5 pipe 17 x 2mm (120m Coil)	54047
PEXcellent5 pipe 17 x 2mm (200m Coil)	54048
PEXcellent5 pipe 17 x 2mm (600m Coil)	54049
PEXcellent5 pipe 20mm (500m Coil)	54050
PEXcellent5 pipe 12mm (80m Coil)	54055
PEXcellent5 pipe 12mm (120m Coil)	54056
PEXcellent5 pipe 12mm (240m Coil)	54057

MULTI-LAYER

MYSON FLOORTEC's multi-layer pipe is available in 16mm diameter. It is a flexible pipe, making it extremely easy to install.



It is compatible with most MYSON FLOORTEC underfloor systems, the only exception being MICROBOARD, where specially manufactured 12mm pipe is required. It is quality guaranteed for 10 years and conforms to DIN4726 and BS7291-1:2001.

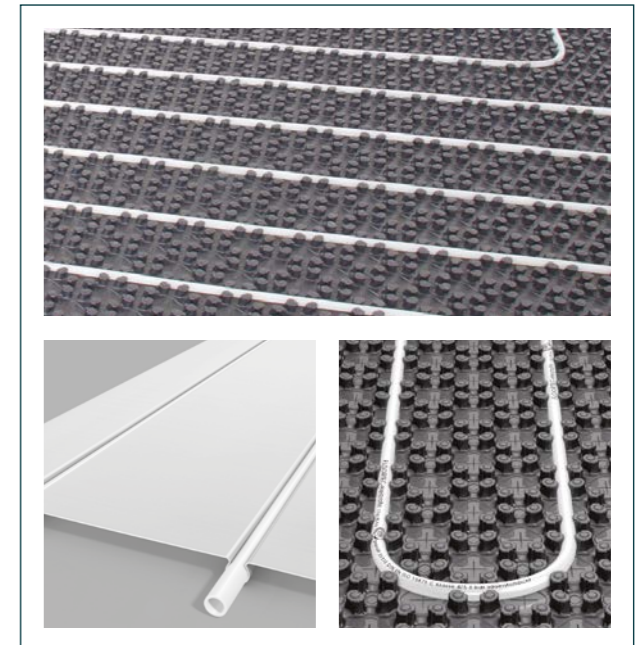

 **DELIVERY**
2 - 5 working days.

Description	Order Code
Multi-layer pipe 16 x 2mm (100m Coil)	53002
Multi-layer pipe 16 x 2mm (200m Coil)	53005
Multi-layer pipe 16 x 2mm (400m Coil)	53004

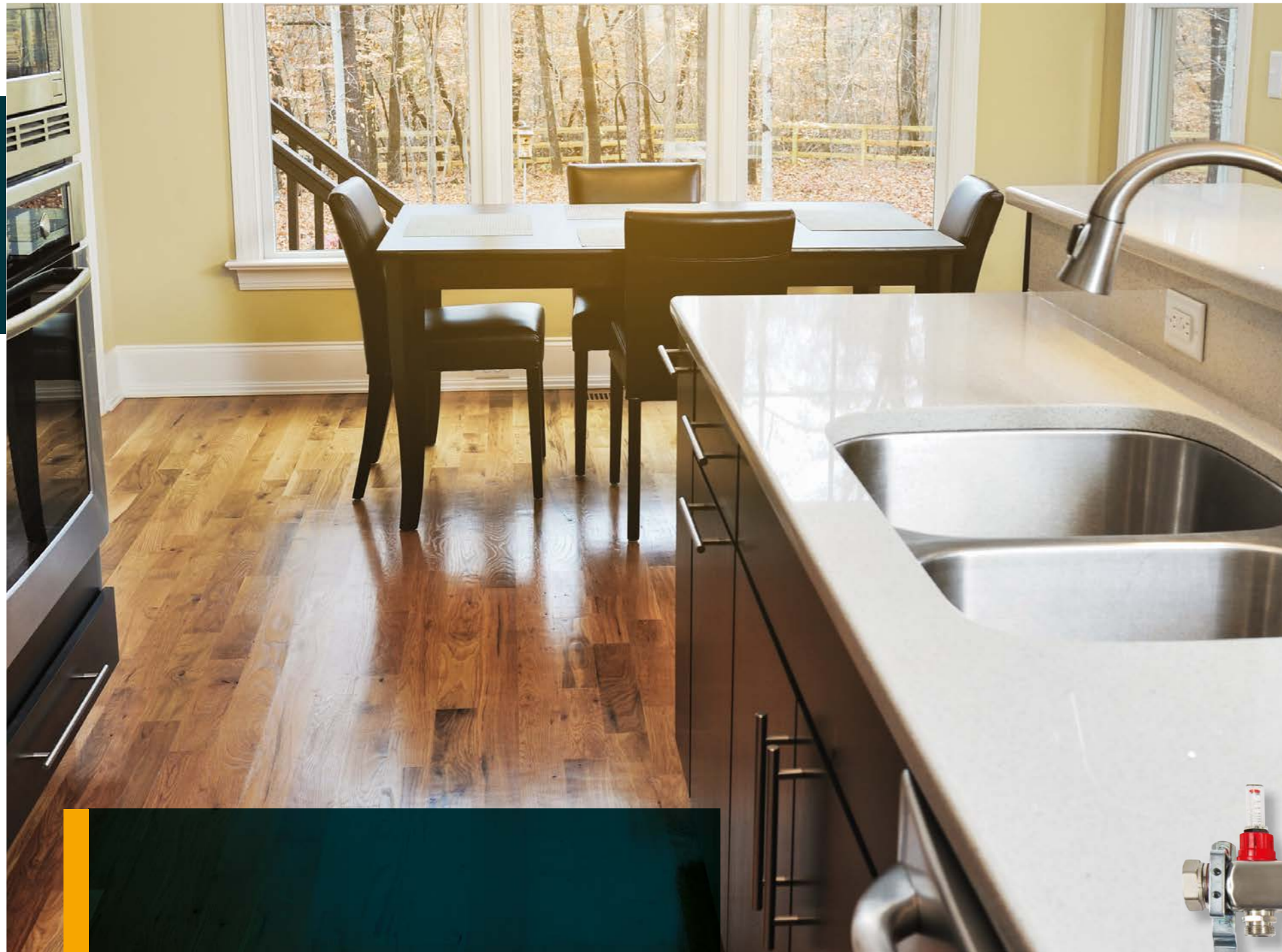

MYSON FLOORTEC underfloor heating offer a full range of quality controls to ensure that you get the most out of our underfloor heating systems. Our controls are designed by our heating experts to meet the requirements of our customers and will perfectly complement our systems.

Controls are an essential part of every underfloor heating system. Each system requires at least one manifold, control centre, wiring centre and thermostat. MYSON FLOORTEC supply quality manifolds, isolating and blending valves and an A-rated pump. MYSON FLOORTEC also supplies wiring centres as well as a range of thermostats from basic digital thermostats to WiFi enabled touch controls.

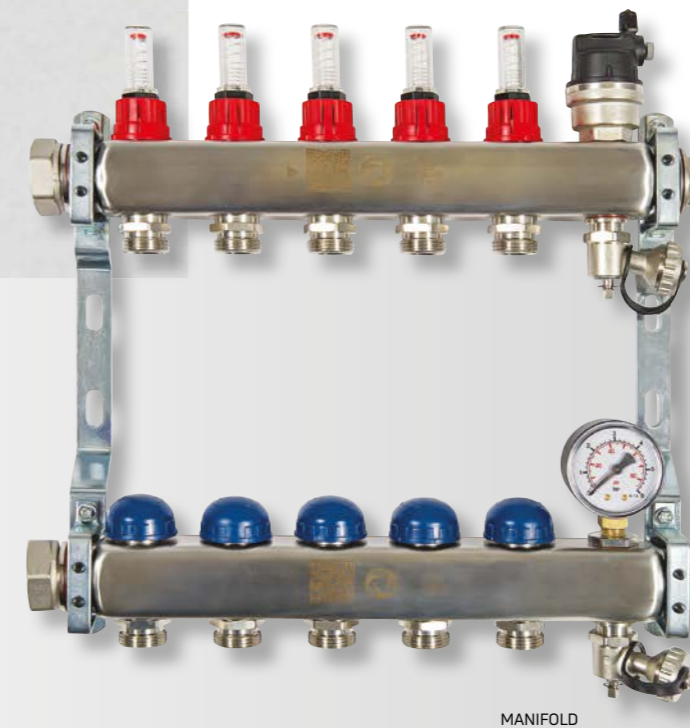

MANIFOLD



UNISENZA WiFi



CONTROLS

UNDERFLOOR HEATING



PREMIUM MANIFOLDS

The MYSON FLOORTEC underfloor heating manifold is the central point to most underfloor heating systems. The manifold is responsible for distributing mixed water provided by the manifold control centre to each heating circuit.



MYSON have introduced their premium manifold as part of the complete bespoke system that is more compact, easier to use, and comes complete with all fittings and fixtures.

It is neat and compact in size and has a number of features and benefits that make it one of the leading manifolds on the market.

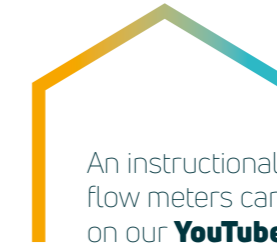

An instructional video for flow meters can be viewed on our **YouTube channel**

UNDERFLOOR HEATING

Mixed circuit flow diagram

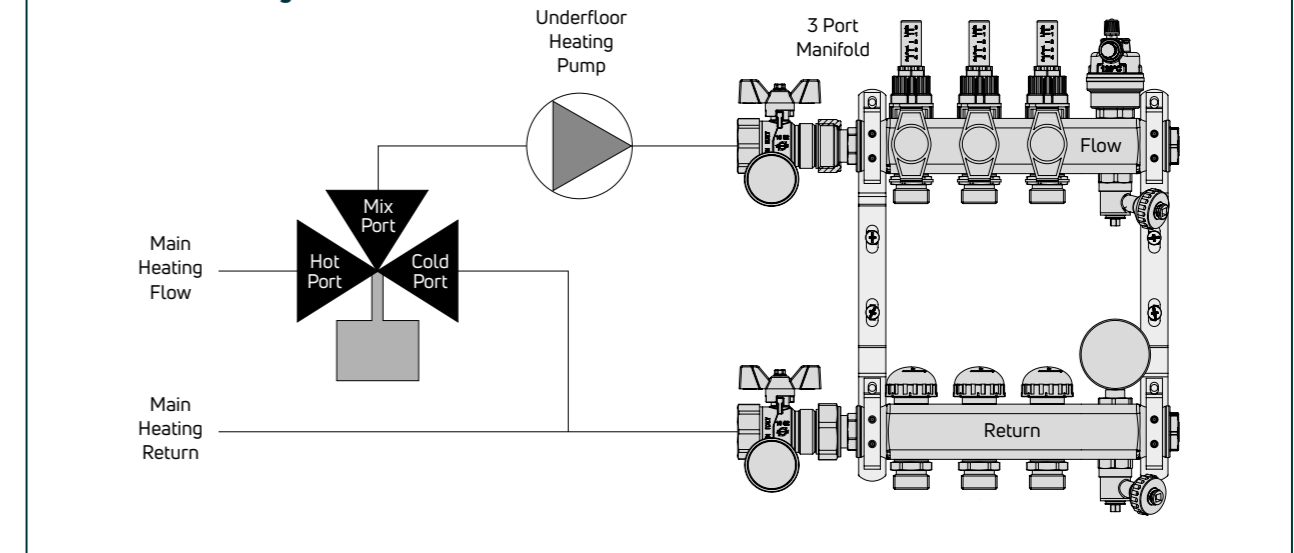

DELIVERY
2 - 5 working days.

Premium manifolds

Description	Order Code
2 port Premium Manifold	99302PR
3 port Premium Manifold	99303PR
4 port Premium Manifold	99304PR
5 port Premium Manifold	99305PR
6 port Premium Manifold	99306PR
7 port Premium Manifold	99307PR
8 port Premium Manifold	99308PR
9 port Premium Manifold	99309PR
10 port Premium Manifold	99310PR
11 port Premium Manifold	99311PR
12 port Premium Manifold	99312PR
Pipe Bend Support 14-17mm	50070
Pipe Bend Support 18-23mm	50071
¼" Blanking Cap	53084

Adaptors

Manifold Coupling for 17 x 2mm Pex	50114
Straight Coupling for 17 x 2mm Pex	50010
Straight Coupling for 14 x 2mm Pex	50020
Manifold Coupling for 20 x 2mm Pex	50113
Straight Coupling for 20 x 2mm Pex	50011
Manifold Coupling for 16 x 2mm Multi-layer	53033
Straight Coupling for 16 x 2mm Multi-layer	53032
15mm Copper Adaptor	40213
14mm x ½" Male Iron Adaptor	50115
17mm x ½" Male Iron Adaptor	50116
Coupling Central Core	50009
Manifold Coupling for 12 x 2mm Pex	50118
Straight Coupling for 12mm x ½" Male Iron Adaptor	50013
1" Straight Swivel Adaptor	99329PR
Standard Connections	50830
Eccentric Connections	50827

Premium manifold & pump pack - manifold dimension details 2-12 port

Number of Ports	Manifold Length(M) (±1mm)	Total Length(L) (±1mm)
2	204	454
3	254	504
4	304	554
5	354	604
6	404	654
7	454	704
8	504	754
9	554	804
10	604	854
11	654	904
12	704	954

Pump pack and manifold sold separately.



PREMIUM PUMP PACK

The next generation pump pack from MYSON FLOORTEC works alongside the premium manifold to control the underfloor heating system, allowing it to work at a lower flow temperature.



50825PR

The pump pack is compatible with all MYSON manifolds, including the leading premium manifolds and is easily installed.

The fully assembled premium pump pack has all the advantages of before, including a high efficiency circulating pump which now comes assembled with a thermostatic mixing valve complete with integral non-return valve and flow regulating valve ideal for balancing large systems.

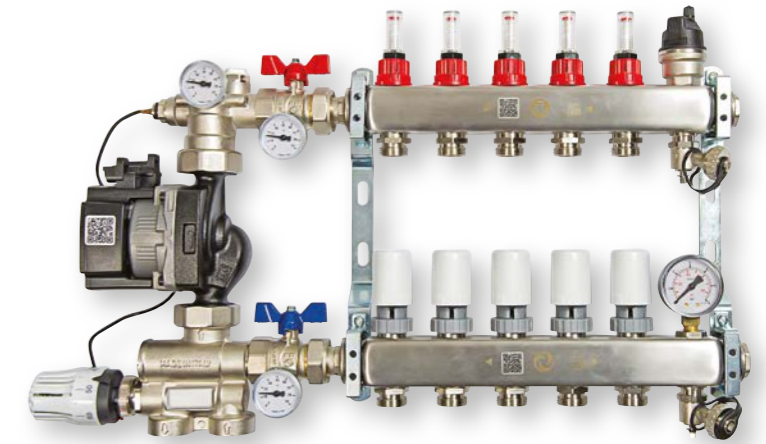

99305PR

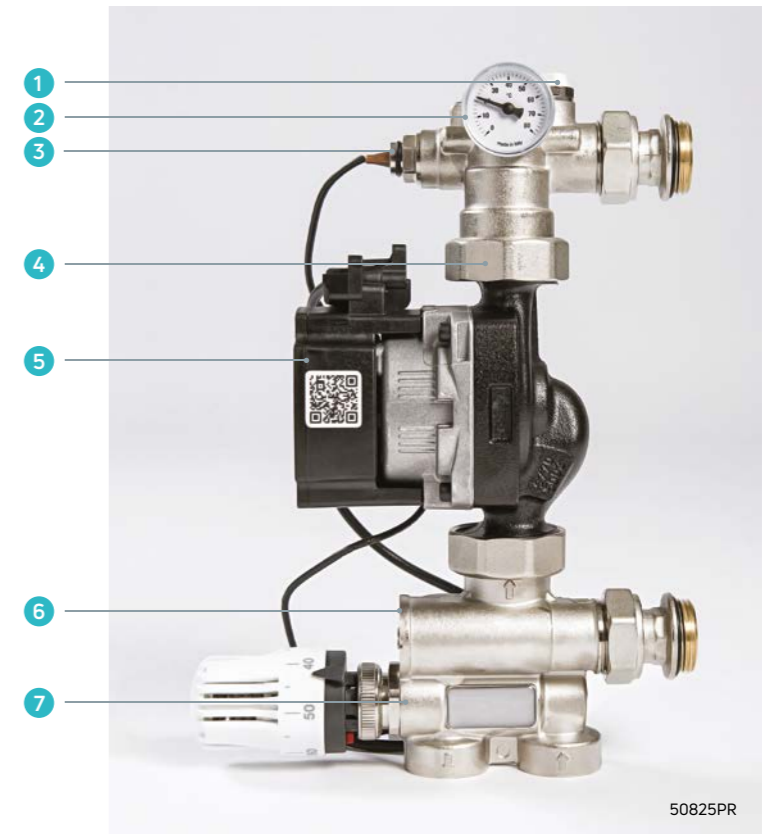

50825PR

- 1 Manual air vent
- 2 0-80°C Temperature gauge
- 3 Remote sensing probe
- 4 Non-return valve
- 5 Grundfos UPM3 high efficiency circulating pump
- 6 Flow increase valve
- 7 Thermostatically controlled mixing valve

 **DELIVERY**
2 - 5 working days.

Description	Order Code
'A' Rated Pump Pack	50825PR
'A' Rated Single Zone Control Unit	50810A
Y-Splitters (Pair)	53036VN
22mm Mixing Valve	52014



WIRING CENTRES & THERMOSTATS

Wiring centres

MYSON FLOORTEC wiring centres come in two different types. A low voltage version for a 24V power supply and a 230V version for a 230V power supply. The wiring centre controls the thermostats and actuators.



50437

Wiring centres & accessories

Description	Order Code
230V Actuator Head	50442
24V Actuator Head	50443
230V Wiring Centre - 10-Way	50437
24V Wiring Centre	50599
230V Wiring Centre - 4-Way	50597
240V Wiring Centre - 5-Way	50436

Dial Thermostats

The MYSON UNISENZA dial thermostat is simple to use, wall mounted and allows for the control of underfloor heating and cooling with a single device. Modern and discrete design with a white matt finish. Available in 24V or 230V.



50430/50431

WiFi Thermostats

MYSON programmable WiFi thermostats will always allow you to control your heating from anywhere in the world. Easy to set up and configure on your smart phone or tablet via the MYSON Apps. 50520 suitable with 230V wiring centre only.



50434/50435



50520

Digital Thermostats

The MYSON UNISENZA digital room thermostat can be simply set for ideal temperature control using the intuitive user display. External sensor can be used for remote air, floor or limit functions.



50432/50433

RF Thermostat

The MYSON MPRT is an easy to use programmable radio frequency room thermostat. It utilises Smart Start technology which could save up to 10% on heating bills. Suitable with a 24V or 230V wiring centre.



50511

Programmable Thermostats

The MYSON TOUCH range of programmable thermostats allow you to set different room temperatures for the morning, day, evening and night time. The range includes the MYSON TOUCH and MYSON TOUCH RS with remote sensor, primarily designed for underfloor systems. Suitable with a 230V wiring centre.



50516

Programmer

The MYSON MEP1c is a single channel time switch for use with combi boilers, or as a domestic hot water control when using a programmable thermostat for the central heating circuit.



50808

DELIVERY
2 - 5 working days.

Thermostats & programmers

Description	Order Code
UNISENZA Dial Thermostat - 230V	50430
UNISENZA Dial Thermostat - 24V	50431
UNISENZA Digital Thermostat - 230V	50432
UNISENZA Digital Thermostat - 24V	50433
Touch Screen Thermostat - 230V	50516
TOUCH c/w Remote Sensor	50517
TOUCH2 WiFi Thermostat	50520
TOUCH2 WiFi Thermostat and Hub	50521
230V UNISENZA WiFi Thermostat	50434
24V UNISENZA WiFi Thermostat	50435
MPRT RF Programmable Thermostat	50511
MEP1c Single Channel Programmer	50808



MYSON FLOORTEC offer a wide range of underfloor heating single room packs. These systems complement MYSON FLOORTEC's bespoke underfloor range. The single room packs are easy to install using a variety of our fixing methods. There are no design requirements and the packs are competitively priced. The single room packs are for water-based heating and are available in a range of sizes to suit various room layouts. Area packs are supplied with 17/2mm pipework, although other pipework is available on request. Punch Packs are supplied with 16mm multi-layer pipe.

The single room packs contain everything you need for underfloor heating in one handy box and are available in pack sizes from 12m² to 40m². They also include a touch screen thermostat.



SINGLE ROOM PACKS

AREA PACKS

MYSON FLOORTEC offer a range of single room packs for screeded and joisted floor types. They are available for a range of fixing systems and are ideal for smaller areas, extensions and refurbishments.



The packs are supplied with everything you need, including 17/2mm PEXcellent5 pipe and a touch screen thermostat.

PUNCH PACKS

MYSON FLOORTEC's Punch Packs for single rooms are designed for a screeded floor. They include specially selected items to provide unbeatable quality and value and come with MYSON's innovative Tackernails, so are easy to install, and everything you need is in one handy box.



They also come with 16mm multi-layer pipe, our A-rated single zone control unit and a MYSON thermostat complete with floor sensor. They are available in 20m² and 40m² pack (based on 200mm spacings). They're a cost effective solution for underfloor heating and backed by MYSON FLOORTEC's technical support and product guarantees.



DELIVERY
2 - 5 working days.

Description	Order Code
Underfloor Heating Pack - Cliprail 12m ²	CLIPRAIL12AY
Underfloor Heating Pack - Cliprail 15m ²	CLIPRAIL15AY
Underfloor Heating Pack - Cliprail 20m ²	CLIPRAIL20AY
Underfloor Heating Pack - Cliprail 30m ²	CLIPRAIL30AY
Underfloor Heating Pack - Cliprail 40m ²	CLIPRAIL40AY
Underfloor Heating Pack - Preformed Plate 12m ²	PFP12AY
Underfloor Heating Pack - Preformed Plate 15m ²	PFP15AY
Underfloor Heating Pack - Preformed Plate 20m ²	PFP20AY
Underfloor Heating Pack - Preformed Plate 25m ²	PFP25AY
Underfloor Heating Pack - Preformed Plate 30m ²	PFP30AY
Underfloor Heating Pack - Preformed Plate 40m ²	PFP40AY
Underfloor Heating Pack - Naked Preformed Plate 12m ²	NAKEDPFP12AY
Underfloor Heating Pack - Naked Preformed Plate 15m ²	NAKEDPFP15AY
Underfloor Heating Pack - Naked Preformed Plate 20m ²	NAKEDPFP20AY
Underfloor Heating Pack - Naked Preformed Plate 25m ²	NAKEDPFP25AY
Underfloor Heating Pack - Naked Preformed Plate 30m ²	NAKEDPFP30AY
Underfloor Heating Pack - Naked Preformed Plate 40m ²	NAKEDPFP40AY
Underfloor Heating Pack - Plated 12m ²	PLATED12AY
Underfloor Heating Pack - Plated 15m ²	PLATED15AY
Underfloor Heating Pack - Plated 20m ²	PLATED20AY
Underfloor Heating Pack - Plated 30m ²	PLATED30AY
Underfloor Heating Pack - Plated 40m ²	PLATED40AY

DELIVERY
2 - 5 working days.

Description	Order Code
Punch Pack 20	PUNCHPACK20
Punch Pack 40	PUNCHPACK40



Electric heating

Electric heating has grown in popularity rapidly in recent years, offering benefits that cannot be provided by conventional heating.

MYSON has a full range of electric products, including practical panel radiators, stylish contemporary and design radiators, a number of attractive and practical towel warmers as well as underfloor heating. Our range is designed to be functional and stylish, offering heating alternatives to areas where there is no gas supply or heating pipes available. Electric heating is perfect for renovation projects, such as bathroom and kitchen refurbishments, extensions and conservatories, as it is easy to install and requires no plumbing.

We also offer practical space saving plinth heaters, see KICKSPACE® on page 144.

Our electric products are manufactured to the same high standards as the rest of the MYSON range and come with a two year warranty from date of purchase.



FINESSE

The FINESSE electric radiator provides all the benefits of central heating without the need for a plumbed in system, so it is perfect for projects that are off-gas or have no central heating pipes in the required space. It comes with a sleek, modern control panel and a precision electronic thermostat with frost protection, providing maximum control and minimum energy consumption. It is manufactured in the UK and has a class 1 electrical protection rating.



Mounting positions, dimensions & wall brackets

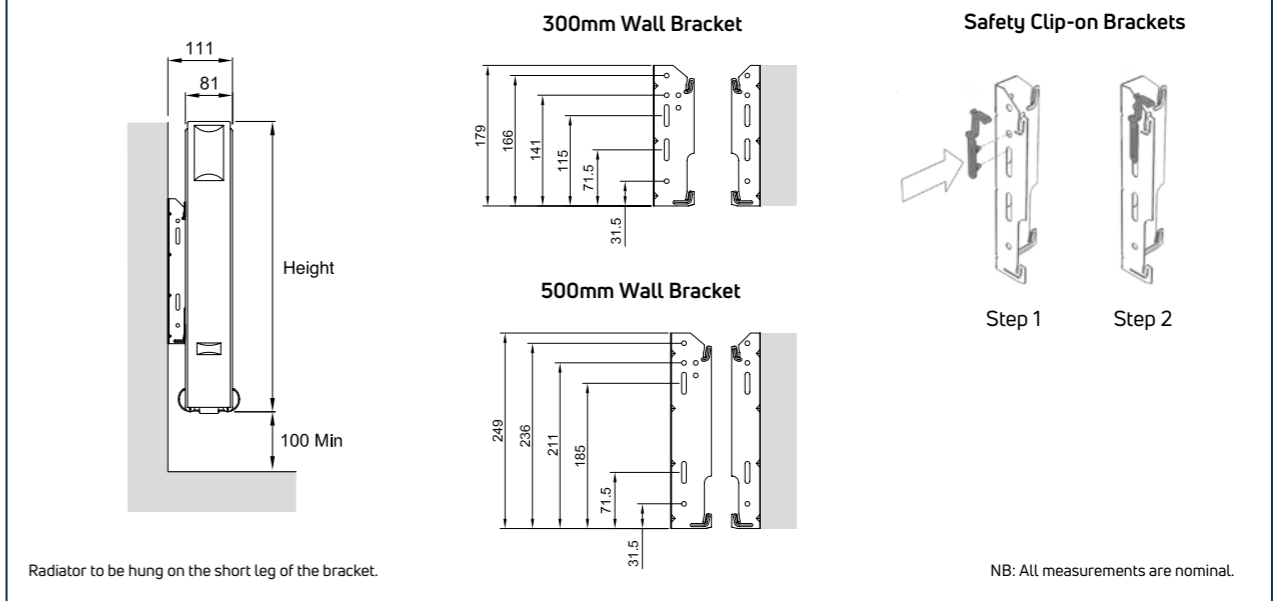

General specification

- CERTIFICATION**
Produced under a quality management system - ISO 9001:2015, environmental management system - ISO 14001:2015 and Occupational health and safety management system - ISO 45001:2018. Carries the CE mark and conforms to the Low Voltage Directive 2014/35/EU and the EMC Directive 2014/30/EU.
- GUARANTEE**
2 year guarantee from date of purchase against manufacturing defects.
- COLOUR**
Finished in white (RAL 9016).
- MATERIAL**
Manufactured from steel and filled with environmentally friendly vegetable oil.
- ACCESSORIES**
TOUCH4 - 4 zone touch screen programmer. Please see page 257.
- SEALED ELECTRIC**
- IP RATED**
IP44.
- DELIVERY**
2 - 5 working days. Non-stocked items: 4 - 6 weeks.
- WASTE DISPOSAL**
According to The WEEE Directive (2012/19/EU). Please see page 265.
- ECO DESIGN DIRECTIVE**
Conforms to the standards (EU) 2015/1188.

For more general information, please see page 264.

Technical characteristics

Measured temperature precision	0.1°C
Operating temperature	-10°C to +50°C
Setting temperature range	+5°C to +30°C
Control characteristics	PWM
Electrical protection	Class 1 - IP44
Power supply	230 VAC - 50 Hz

For more information, please refer to the installation instructions available on our website.

Accessories

Product	Order Code
TOUCH4* - 4 Zone, Touch Screen Programmer (hard wired)	TOUCH4 - refer to page 257
90° Adaptor - For side arrangement of the RIO control, suitable for RIO COMPACT PLUS, RIO PLAN PLUS and RIO LINEA PLUS (also can be used with MYSON FINESSE control).	RIOPLUS90ADAP

*Please refer to our website for wiring diagram.

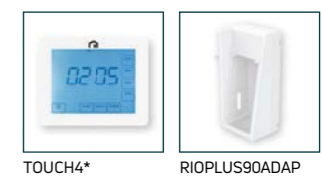

Technical information & heat outputs

Order Code	Nominal Height (mm)	Nominal Length (mm)	Weight (packed - kg)	Rated Watts
FE30DX50	300	500	10.5	500
FE30DX80*	300	800	16.5	750
FE30DX100	300	1000	20.5	1000
FE30DX130*	300	1300	25.5	1250
FE30DX160	300	1600	31.5	1500
FE30DX200*	300	2000	38.5	2000
FE50DX40	500	400	14.0	500
FE50DX50	500	500	17.0	750
FE50DX65	500	650	21.5	1000
FE50DX80	500	800	25.5	1250
FE50DX95	500	950	29.5	1500
FE50DX125	500	1250	39.1	2000

*Non-stock - made to order only.



RIO PLUS

The RIO PLUS Range is a modern electric panel radiator with unique and energy saving features built in to the electronics. It is available in three models RIO COMPACT PLUS, RIO PLAN PLUS and RIO LINEA PLUS, all models offer superb temperature controllability via a clear visual digital display discreetly housed on the side panel. All models are fully programmable, with several operating modes including; open window function, frost protection and an adjustable surface temperature which creates a comfortable, radiant warmth. RIO PLUS radiators can now be controlled via the UNISENZA PLUS app, using the UNISENZA PLUS Gateway, as well as via voice control linked to any of the well-known home automation systems on the market.



RIO COMPACT PLUS

Download the **UNISENZA PLUS App** for wireless connection and control (with Gateway)



RIO COMPACT PLUS



RIO PLAN PLUS

RIO LINEA PLUS



Digital Control

RIO PLAN PLUS

The sleek flat front panel design of the RIO PLAN PLUS offers a contemporary alternative to the traditional RIO COMPACT PLUS radiator.

RIO LINEA PLUS

The RIO LINEA PLUS model takes this modern styling one step further with a decorative, rather than flat, front panel.

RIO PLUS RANGE

General specification & technical information

CERTIFICATION
Produced under a quality management system - ISO 9001:2015, environmental management system - ISO 14001:2015 and Occupational health and safety management system - ISO 45001:2018. Carries the CE and UKCA mark and conforms to the Low Voltage Directive 2014/35/EU and the EMC Directive 2014/30/EU.

GUARANTEE
2 year guarantee from date of purchase against manufacturing defects.

COLOUR
Finished in white (RAL 9016).

MATERIAL
Manufactured from steel and filled with environmentally friendly vegetable oil.

ACCESSORIES
TOUCH4 - 4 zone touch screen programmer. Please see page 257.
UNISENZA PLUS high-end gateway - for programming with Smartphone App. Please see page 259.

SEALED ELECTRIC

IP RATING
IP44.

DELIVERY
2 - 5 working days.
Non-stocked items: 3 - 4 weeks.

WASTE DISPOSAL
According to The WEEE Directive (2012/19/EU). Please see page 265.

ECO DESIGN DIRECTIVE
Conforms to the standards (EU) 2015/1188.

For more general information, please see page 264.

Technical characteristics

Measured temperature precision	0.1°C
Operating temperature	-30°C to +50°C
Setting temperature range	+0.5°C to +30°C
Electrical protection	Class 1 - IP44
Power supply	230 VAC - 50 Hz

For more technical information, please refer to the installation instructions available on our website.

Accessories

Product	Order Code
TOUCH4* - 4 Zone, Touch Screen Programmer (hard wired)	TOUCH4 - refer to page 257
UNISENZA PLUS Gateway - Enables remote management through a mobile application with the UNISENZA App: - Adjust the temperature of each room - Create and manage one or more comfort zones	UNIPLGATEWAY - refer to page 259
90° Adaptor - For side arrangement of the RIO control, suitable for RIO COMPACT PLUS, RIO PLAN PLUS and RIO LINEA PLUS (also can be used with MYSON FINESSE control).	RIOPLUS90ADAP

*Please refer to our website for wiring diagram.



RIO PLAN PLUS



RIO LINEA PLUS

Mounting positions, dimensions & wall brackets

*+3mm for PLAN PLUS and LINEA PLUS models

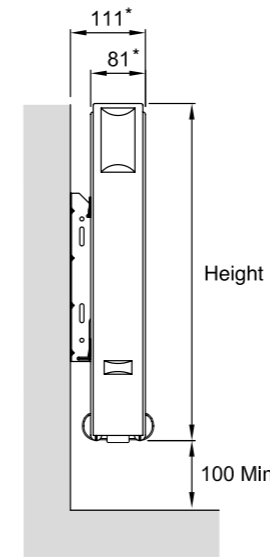

Radiator to be hung on the short leg of the bracket.

300mm Wall Bracket

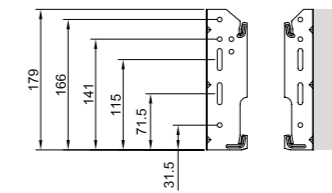

500mm Wall Bracket

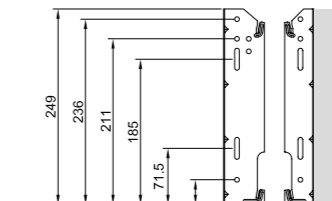

Safety Clip-on Brackets

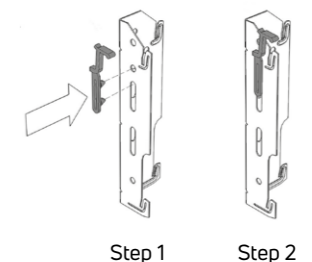

Step 1 Step 2

NB: ALL measurements are nominal.

Technical information & heat outputs

RIO COMPACT PLUS

Order Code	Nominal Height (mm)	Nominal Length (mm)	Weight (packed - kg)	Rated Watts
RIOC30DX50Z	300	500	12.0	500
RIOC30DX80Z	300	800	16.9	750
RIOC30DX100Z	300	1000	20.5	1000
RIOC30DX130Z	300	1300	26.5	1250
RIOC30DX160Z	300	1600	31.5	1500
RIOC30DX200Z	300	2000	38.5	2000
RIOC50DX40Z	500	400	14.6	500
RIOC50DX50Z	500	500	17.0	750
RIOC50DX65Z	500	650	21.5	1000
RIOC50DX80Z	500	800	24.6	1250
RIOC50DX95Z	500	950	31.0	1500
RIOC50DX125Z	500	1250	38.6	2000

RIO PLAN PLUS

RIOP30DX50Z*	300	500	13.3	500
RIOP30DX80Z*	300	800	18.9	750
RIOP30DX100Z*	300	1000	23.0	1000
RIOP30DX130Z*	300	1300	29.8	1250
RIOP30DX160Z*	300	1600	35.6	1500
RIOP30DX200Z*	300	2000	43.6	2000
RIOP50DX40Z*	500	400	16.3	500
RIOP50DX50Z*	500	500	19.1	750
RIOP50DX65Z*	500	650	24.2	1000
RIOP50DX80Z*	500	800	27.9	1250
RIOP50DX95Z*	500	950	35.0	1500
RIOP50DX125Z*	500	1250	43.8	2000

RIO LINEA PLUS

RIOL30DX50Z*	300	500	13.3	500
RIOL30DX80Z*	300	800	18.9	750
RIOL30DX100Z*	300	1000	23.0	1000
RIOL30DX130Z*	300	1300	29.8	1250
RIOL30DX160Z*	300	1600	35.6	1500
RIOL30DX200Z*	300	2000	43.6	2000
RIOL50DX40Z*	500	400	16.3	500
RIOL50DX50Z*	500	500	19.1	750
RIOL50DX65Z*	500	650	24.2	1000
RIOL50DX80Z*	500	800	27.9	1250
RIOL50DX95Z*	500	950	35.0	1500
RIOL50DX125Z*	500	1250	43.8	2000

*Non-stock - made to order only.



HYDRONIC MODEL AVAILABLE
Please see page 88

ELECTRIC DÉCOR

The electric DÉCOR is a stylish, contemporary alternative to a traditional radiator. An electric version of our popular hydronic model, the distinctive flat tube design will enhance the look of any room. It is suitable for a wide range of uses, both domestic and commercial. It is also perfect for projects that are off-gas or have no central heating pipes installed.



ELECTRIC DÉCOR HORIZONTAL

ELECTRIC DÉCOR VERTICAL

Dimensions

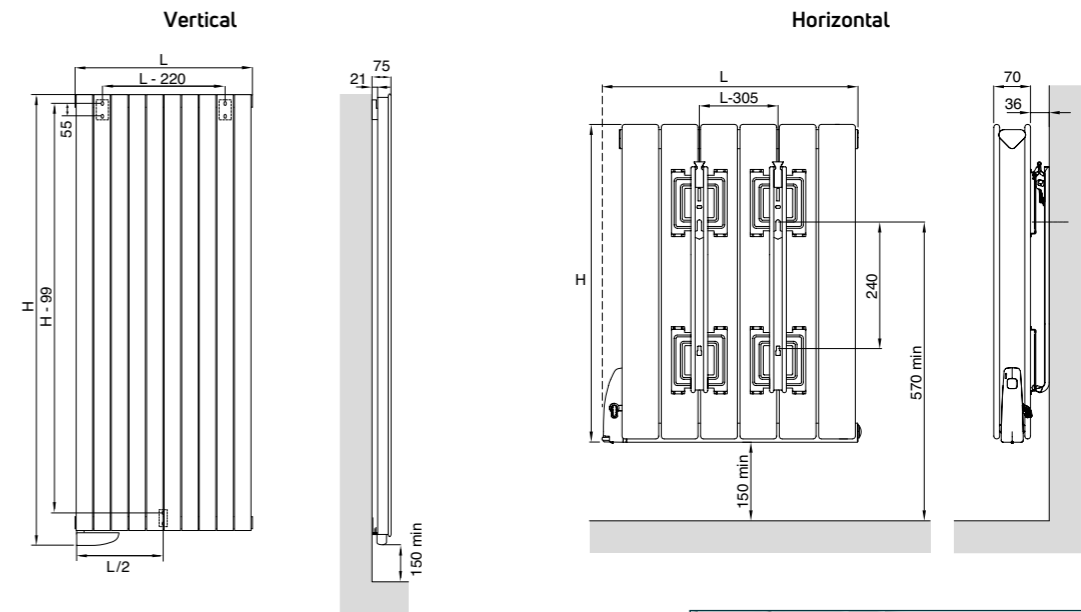

NB: All measurements are nominal.

General specification

- CERTIFICATION**
Produced under a quality management system - ISO 9001:2015, environmental management system - ISO 14001:2015 and Occupational health and safety management system - OHSAS 18001. Carries the CE mark and conforms to the Low Voltage Directive 2014/35/EU and the EMC Directive 2014/30/EU.
 - ACCESSORIES**
TOUCH4 - 4 zone touch screen programmer. Please see page 257.
 - SEALED ELECTRIC**
 - IP RATING**
IP44.
 - DELIVERY**
2 - 5 working days. Non-stocked items: 7 - 9 weeks.
 - WASTE DISPOSAL**
According to The WEEE Directive (2012/19/EU). Please see page 265.
 - GUARANTEE**
2 year guarantee from date of purchase against manufacturing defects.
 - COLOUR**
Finished in white (RAL 9016).
 - ECO DESIGN DIRECTIVE**
Conforms to the standards (EU) 2015/1188.
 - MATERIAL**
Manufactured from 1.25mm steel. Horizontal filled with a glycol mix, part water/ part anti-freeze. Vertical filled with mineral oil.
- For more general information, please see page 264.



Accessories

Product	Order Code
Remote Control Thermostat (supplied)	ELECTHERMO5* (for replacements)
TOUCH4** - 4 Zone, Touch Screen Programmer (hard wired)	TOUCH4 - refer to page 257

**Please refer to our website for wiring diagram.

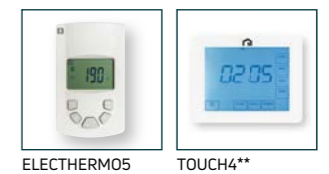

Technical information & heat outputs

ELECTRIC DÉCOR vertical

Order Code	Nominal Height (H) (mm)	Nominal Length (L) (mm)	Weight (kg)	Rated Watts
E6V10180	1835	455	30.36	1000
E9V10180*	1835	680	41.86	1500

ELECTRIC DÉCOR horizontal

E6V20060*	600	485	17.94	500
E8V20060*	600	635	23.00	750
E11V20060*	600	860	30.82	1000
E13V20060*	600	1010	36.80	1250

*Non-stock - made to order only.



HYDRONIC MODEL AVAILABLE
Please see page 82

ELECTRIC COLUMN

The classic good looks of the electric COLUMN will add an elegant style to any project. An electric version of the popular hydronic model, the COLUMN is suitable for both domestic and commercial projects. The electric COLUMN is the world's first full laser radiator, meaning there are no joints. It is also perfect for projects that are off-gas or have no central heating pipes installed.

ELECTRIC COLUMN HORIZONTAL



ELECTRIC COLUMN VERTICAL

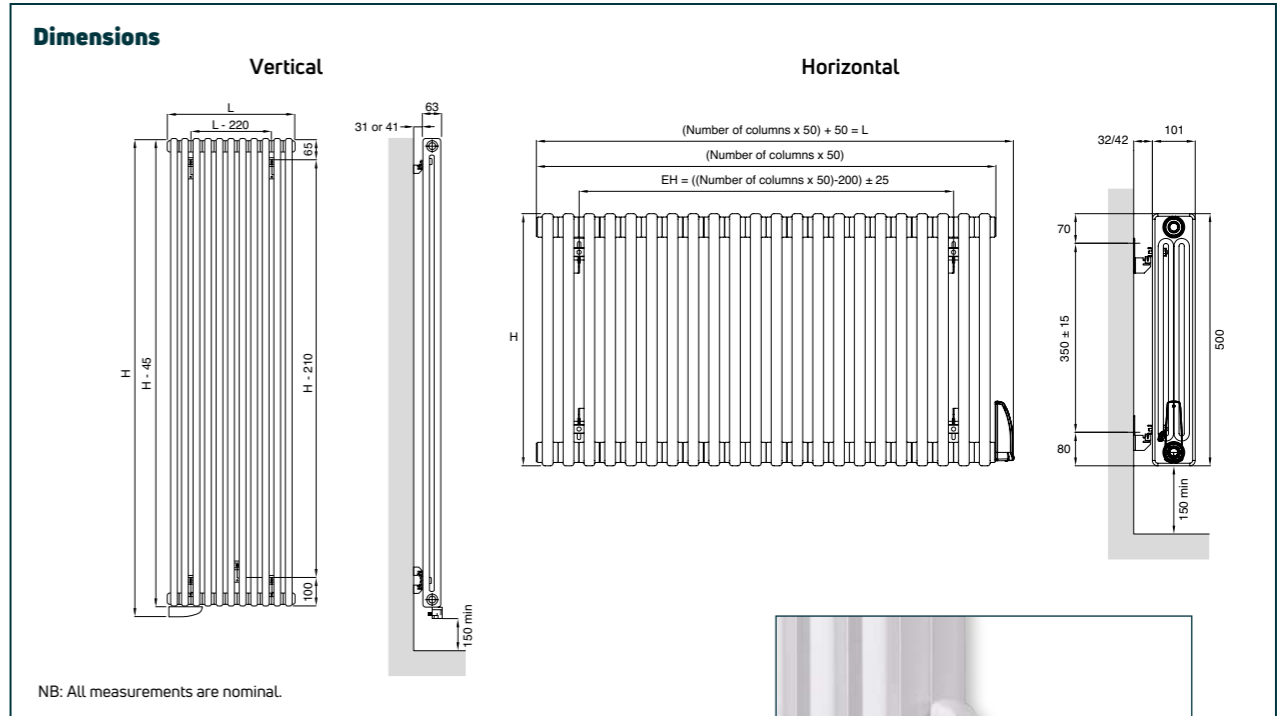

General specification

- CERTIFICATION**
Produced under a quality management system - ISO 9001:2015, environmental management system - ISO 14001:2015 and Occupational health and safety management system - OHSAS 18001. Carries the CE mark and conforms to the Low Voltage Directive 2014/35/EU and the EMC Directive 2014/30/EU.
 - GUARANTEE**
2 year guarantee from date of purchase against manufacturing defects.
 - COLOUR**
Finished in white (RAL 9016).
 - MATERIAL**
Manufactured from 1.25mm steel. Filled with a glycol mix, part water/ part anti-freeze.
 - ACCESSORIES**
TOUCH4 - 4 zone touch screen programmer. Please see page 257.
 - SEALED ELECTRIC**
 - IP RATING**
IP44.
 - DELIVERY**
2 - 5 working days.
 - WASTE DISPOSAL**
According to The WEEE Directive (2012/19/EU). Please see page 265.
 - ECO DESIGN DIRECTIVE**
Conforms to the standards (EU) 2015/1188.
- For more general information, please see page 264.



Accessories

Product	Order Code
Towel Rail (white with chrome fixings)	12SECRAIL ▲
Micro Fibre Cleaning Brush	COLUMNBRUSH2
Remote Control Thermostat (supplied)	ELECTHERMO* (for replacements)
TOUCH4** - 4 Zone, Touch Screen Programmer (hard wired)	TOUCH4 - refer to page 257

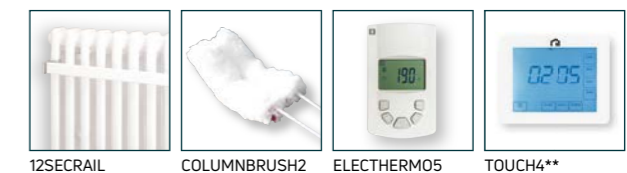

**Please refer to our website for wiring diagram.
▲ Towel rail only available for products with this symbol.

Technical information & heat outputs

ELECTRIC COLUMN vertical

Order Code	Nominal Height (H) (mm)	Nominal Length (L) (mm)	Weight (kg)	Rated Watts
E8SEC2180	1845	400	34.87	1000
E12SEC2180▲	1845	600	51.89	1500

ELECTRIC COLUMN horizontal

Order Code	Nominal Height (H) (mm)	Nominal Length (L) (mm)	Weight (kg)	Rated Watts
E8SEC3060	600	450	20.42	500
E10SEC3060	600	550	24.01	750
E12SEC3060▲	600	650	28.80	1000
E14SEC3060	600	750	33.86	1250

*Non-stock - made to order only.



ELECTRIC AVONMORE

The electric model of our most popular towel warmer, AVONMORE, combines all the benefits of the hydronic range, with the advantages of electric heating. It is a classic multi-rail design that is available in a range of sizes, finishes and straight or curved models. This makes it an extremely popular specification product for new build. It has three rail configurations and tube spacing for practical towel placement and is a flexible choice for any project.



ELECTRIC AVONMORE STRAIGHT

Dimensions

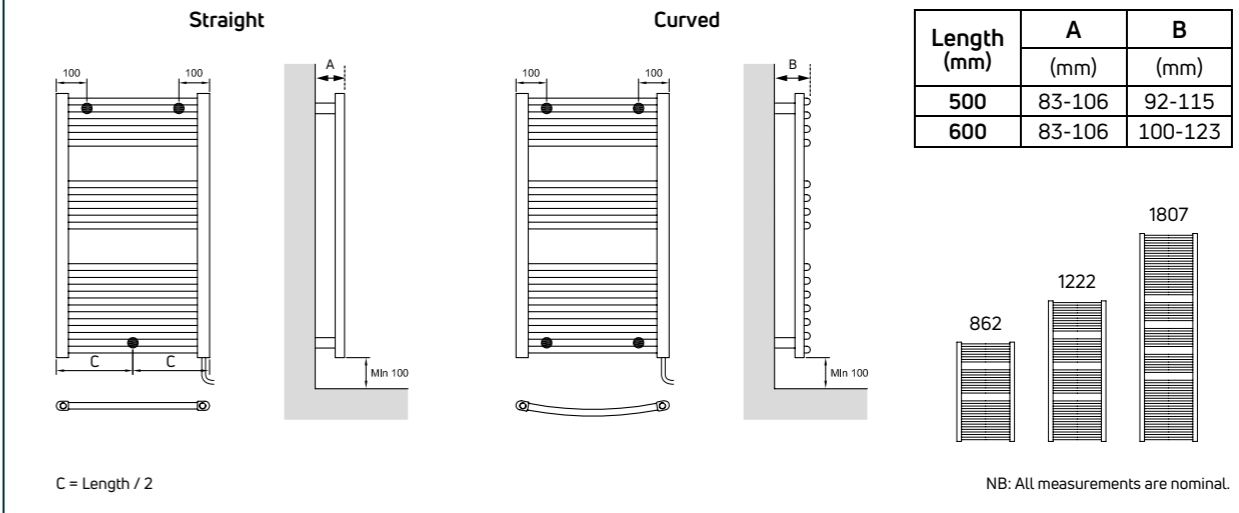

General specification

- CERTIFICATION**
Produced under a quality management system - ISO 9001:2015, environmental management system - ISO 14001:2015 and Occupational health and safety management system - OHSAS 18001. Carries the CE mark and conforms to the Low Voltage Directive 2014/35/EU and the EMC Directive 2014/30/EU.
- GARANTEE**
2 year guarantee from date of purchase against manufacturing defects.
- COLOUR**
Finished in white (RAL 9016) or chrome.
- MATERIAL**
Manufactured from steel. Filled with a glycol mix, part water/part anti-freeze.
- ACCESSORIES**
Please see page 140.
- SEALED ELECTRIC**
- IP RATING**
IP67.
- DELIVERY**
2 - 5 working days.
Non-stocked items:
7 - 9 weeks.
- WASTE DISPOSAL**
According to The WEEE Directive (2012/19/EU). Please see page 265.
- ECO DESIGN DIRECTIVE**
Out of Scope. Towel warmers exempt from Directive.



ELECTRIC AVONMORE CURVED

For more general information, please see page 264.

Technical information & heat outputs

ELECTRIC AVONMORE straight

Order Code		Nominal Height (mm)	Nominal Length (mm)	Weight (kg)	Rated Watts
White	Chrome				
EECOS85W	EECOS85C	862	500	13.00	450
EECOS125W*	EECOS125C	1222	500	17.80	450
EECOS126W*	EECOS126C	1222	600	18.70	450
EECOS185W*	EECOS185C*	1807	500	24.20	450

ELECTRIC AVONMORE curved

EECOC85W*	EECOC85C*	862	500	13.00	450
EECOC125W	EECOC125C	1222	500	17.80	450
EECOC126W*	EECOC126C*	1222	600	18.70	450
EECOC185W*	EECOC185C*	1807	500	24.20	450

*Non-stock - made to order only.



TAMAR E080



TAMAR E070

TAMAR

TAMAR electric towel warmers are innovative and practical designs that bring all the benefits of electrical heating into your bathroom. These towel warmers are easy to install, virtually maintenance free, and do not require any plumbing.

TAMAR E070 is an innovative, curved design that rotates 180° to give extra flexibility.

TAMAR E080 is an attractive curvy, serpentine design.

TAMAR E090 is a neat and compact design ideal for smaller spaces.

TAMAR E0130 is similar in design to the E090 but a taller alternative.

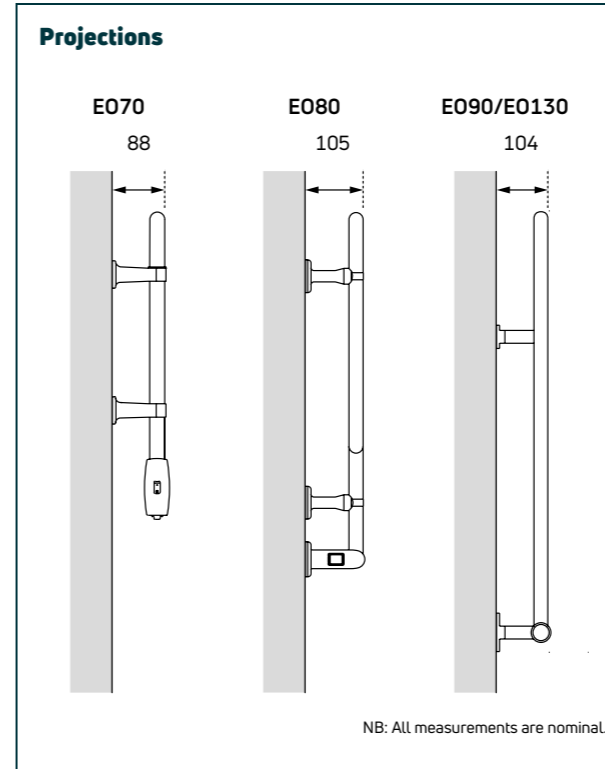

TAMAR E090



TAMAR E0130

General specification

- CERTIFICATION**
Produced under a quality management system - ISO 9001:2015, environmental management system - ISO 14001:2015 and Occupational health and safety management system - OHSAS 18001. Carries the CE mark and conforms to the Low Voltage Directive 2014/35/EU and the EMC Directive 2014/30/EU.
- ACCESSORIES**
Please see page 140.
- SEALED ELECTRIC**
- IP RATING**
E070 & E080: IP44
E090 & E0130: IP64
- DELIVERY**
Non-stocked item: 7 - 9 weeks.
- GUARANTEE**
2 year guarantee from date of purchase against manufacturing defects.
- APM® TECHNOLOGY**
E090 & E0130 are fitted with the latest APM® element technology. Please see page 265.
- WASTE DISPOSAL**
According to The WEEE Directive (2012/19/EU). Please see page 265.
- COLOUR**
Finished in chrome.
- MATERIAL**
Manufactured from steel. Filled with a glycol mix, part water/part anti-freeze. E080 contains a dry element only.
- ECO DESIGN DIRECTIVE**
Out of Scope. Towel warmers exempt from Directive.

For more general information, please see page 264.

Technical information & heat outputs

Order Code	Nominal Height (mm)	Nominal Length (mm)	Weight (kg)	Rated Watts
E070*	505	604	4.50	70
E080*	644	483	5.00	55
E090*	638	584	5.80	75
E0130*	886	584	6.70	100

*Non-stock - made to order only.



INNOKO

Simple and attractive, INNOKO has been designed with a small bathroom, kitchen or cloakroom in mind. This electric towel warmer is available in straight or curved models with left and right hand options. INNOKO is easy to install, virtually maintenance free and can be used alongside KICKSPACE® to provide the perfect drying and heating solution for any kitchen, see page 144. Fitted with APM® technology, the INNOKO is manufactured from brass with a high quality chrome plated finish.



INNOKO CURVED
(RIGHT HAND CONNECTION)

Dimensions

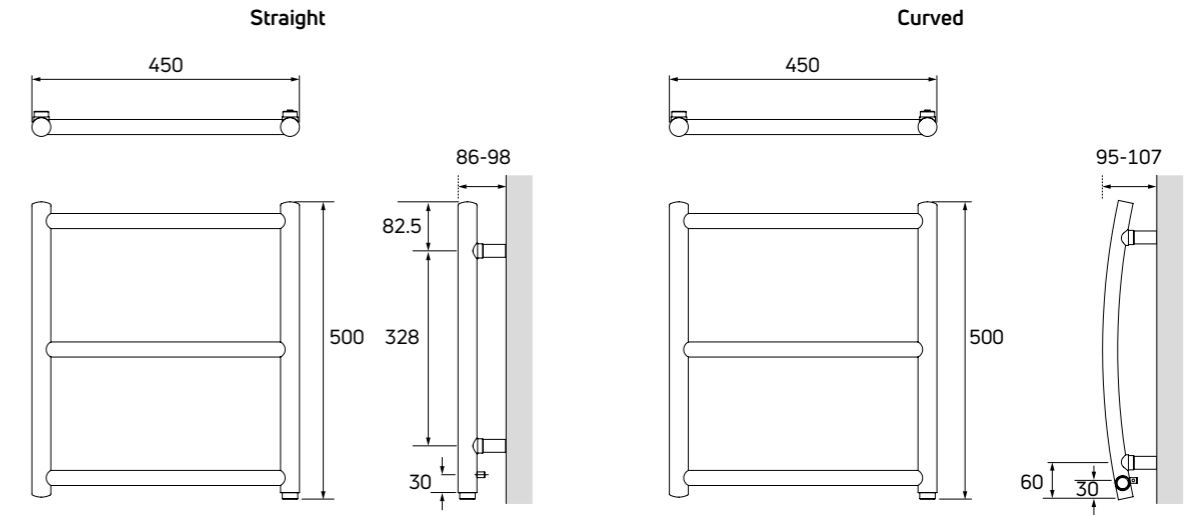

NB: All measurements are nominal.

General specification

- CERTIFICATION**
Produced under a quality management system - ISO 9001:2015, environmental management system - ISO 14001:2015 and Occupational health and safety management system - OHSAS 18001. Carries the CE mark and conforms to the Low Voltage Directive 2014/35/EU and the EMC Directive 2014/30/EU.
- ACCESSORIES**
Please see page 140.
- SEALED ELECTRIC**
- IP RATING**
IP64.
- DELIVERY**
Non-stocked item: 7 - 9 weeks.
- APM® TECHNOLOGY**
Fitted with the latest APM® element technology. Please see page 265.
- WASTE DISPOSAL**
According to The WEEE Directive (2012/19/EU). Please see page 265.
- GUARANTEE**
2 year guarantee from date of purchase against manufacturing defects.
- COLOUR**
Finished in chrome.
- ECO DESIGN DIRECTIVE**
Out of Scope. Towel warmers exempt from Directive.



INNOKO STRAIGHT
(RIGHT HAND CONNECTION)

For more general information, please see page 264.

Technical information & heat outputs

INNOKO straight

Order Code	Connection Position	Nominal Height (mm)	Nominal Length (mm)	Weight (kg)	Rated Watts
PETSCL*	LEFT	500	500	5.0	40
PETSCR*	RIGHT	500	500	5.0	40

INNOKO curved

PETCCL*	LEFT	500	500	5.0	40
PETCCR*	RIGHT	500	500	5.0	40

*Non-stock - made to order only.











ELECTRIC UNDERFLOOR HEATING

MYSON electric underfloor heating is a great alternative for small areas where hydronic underfloor heating is not suitable, such as kitchens, bathrooms, and conservatories. It is ideal for self-builds, renovations and extensions and is extremely easy to install, with no need for specialist tools, skills or groundwork.

It provides instant heat whenever you need it and everything you need is packed and supplied in one box. It comes in a range of sizes from 1m² - 10m², and can be installed on to either tile cement, or screeded floors up to 20m². The one box solution contains an electric mat, digital clock thermostat, control card, floor sensor, sensor tube, multimeter and installation manual. Electric underfloor heating can be used under tile, stone or wood floorings*.

*Please check manufacturer's guidelines

General specification

-  **CERTIFICATION**
Produced under a quality management system - ISO 9001:2015. Carries the CE mark and conforms to the Low Voltage Directive 2014/35/EU.
-  **DELIVERY**
2 - 5 working days.
-  **GUARANTEE**
Electric Mat:
10 year guarantee from date of purchase against manufacturing defects.
-  **WASTE DISPOSAL**
According to The WEEE Directive (2012/19/EU). Please see page 265.
-  **GUARANTEE**
Thermostat & Sensor:
2 year guarantee from date of purchase against manufacturing defects.
-  **ECO DESIGN DIRECTIVE**
Out of scope. Exempt from Directive.
-  **SEALED ELECTRIC**
-  **IP RATING**
IP30.
-  **PERFORMANCE**
Quick warm up delivering 150W/m².

For more general information, please see page 264.



ELECTRIC UNDERFLOOR PACK

Order Code	Size m ²
UF1M	1
UF1.5M	1.5
UF2M	2
UF2.5M	2.5
UF3M	3
UF3.5M	3.5
UF4M	4
UF4.5M	4.5
UF5M	5
UF6M	6
UF7M	7
UF8M	8
UF9M	9
UF10M	10

Can be used under:

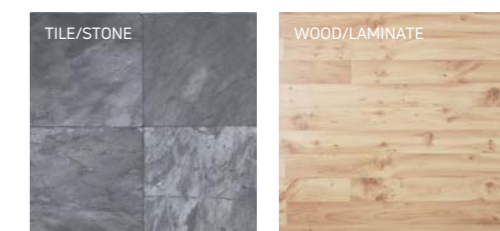



Heating valves

MYSON has been manufacturing heating valves for over 50 years, producing millions of units on an annual basis. Using environmentally friendly chrome 3 for our manual valves and TRV products, our high-quality heating valves are assembled in the UK, and all supplied using sustainable and responsible packaging.

The range covers cost-effective manual valves, thermostatically controlled valves, smart TRV heads to suit all MYSON TRV bodies, decorative valves and options specifically for our LST products. Our extensive offering means we have a solution for any application.

All MYSON valves are produced under ISO 9001:2008, so whichever of our products you choose, you are guaranteed they will be the highest quality.

MATCHMATE

The MATCHMATE range of radiator valves is ideal for use within central heating systems in the domestic housing market. They are available in a number of different models, including compression, pushfit, straight and angled, to suit varying specification requirements. All products are finished in chrome 3 and feature impact resistant valve caps, providing the highest quality at competitive prices. Drain off option also available on most products.



MATE15WAC

General specification

CERTIFICATION
Produced under a quality management system - ISO 9001:2008. Pressure tested in accordance with BS 2767.

GUARANTEE
2 year guarantee from date of purchase against manufacturing defects.

COLOUR
Finished in chrome.

CONNECTIONS
Compression and pushfit.

OPERATING PRESSURES
Operating pressure 10 bar (compression) and 3 bar (pushfit).

OPERATING TEMPERATURE
Operating temperature 120°C (compression) and 92°C (pushfit).

DELIVERY
2 - 5 working days.

For more general information, please see page 264.

MATCHMATE compression

Description	Colour (Top)	Wheel Head Order Code	Lockshield Order Code	Minimum Order Qty
½" Imperial Olive Compression Angle Chrome - Republic of Ireland only	White	MATE1/2WAC	MATE1/2LAC	10
½" Imperial Olive Compression Angle Chrome Drain Off - Republic of Ireland only	White	-	MATE1/2LACD	10
½" Imperial Olive Compression Straight Chrome - Republic of Ireland only	White	MATE1/2WSC	MATE1/2LSC	10
10mm Angle Chrome	White	MATE10WAC	MATE10LAC	10
10mm Angle Chrome C/W Compression 90° Elbow	White	MATE10WAC90	MATE10LAC90	10
10mm Angle Chrome Drain Off	White	-	MATE10LACD	10
10mm Angle Chrome Drain Off C/W Compression 90° Elbow	White	-	MATE10LACD90	10
15mm Angle Chrome	White	MATE15WAC	MATE15LAC	10
15mm Angle Chrome Drain Off	White	-	MATE15LACD	10
15mm Straight Chrome	White	MATE15WSC	MATE15LSC	10

MATCHMATE pushfit

10mm Angle Chrome C/W Pushfit 90° Elbow	White	MATE10WACPF90	MATE10LACPF90	10
10mm Angle Chrome Drain Off C/W Pushfit 90° Elbow	White	-	MATE10LACDPF90	10
10mm Angle Chrome Drain Off Pushfit	White	-	MATE10LACDPF	10
10mm Angle Chrome Pushfit	White	MATE10WACPF	MATE10LACPF	10
10mm Straight Chrome Pushfit	White	-	MATE10LSCPF	10
15mm Angle Chrome C/W Pushfit 90° Elbow	White	MATE15WACPF90	MATE15LACPF90	10
15mm Angle Chrome Drain Off C/W Pushfit 90° Elbow	White	-	MATE15LACDPF90	10
15mm Angle Chrome Pushfit	White	MATE15WACPF	MATE15LACPF	10

MATCHMATE accessories

MATCHMATE Top Only	White	MATEWHTOP	MATELSTOP	20
--------------------	-------	-----------	-----------	----

Technical information

Dimensions

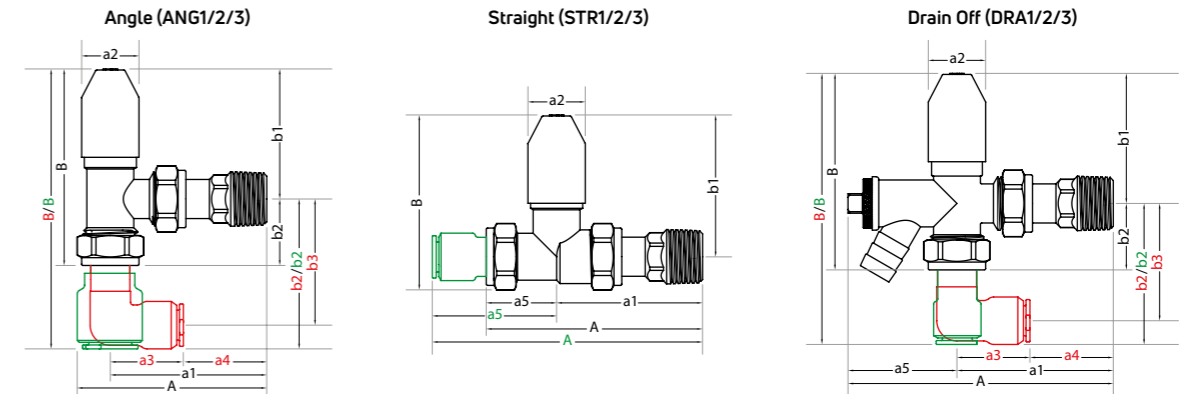

DRAWING REFERENCE: 1 = Standard (Black); 2 = Pushfit (Green & Black); 3 = Pushfit 90° Elbow (Red & Black). Drawings for illustration purposes only.

Model	DWG Ref.	A (mm)	a1 (mm)	a2 (mm)	a3 (mm)	a4 (mm)	a5 (mm)	B (mm)	b1 (mm)	b2 (mm)	b3 (mm)
MATCHMATE											
½" Imperial Olive Compression Wheelhead Angle Chrome - Republic of Ireland only	ANG1	76	60	31	-	-	-	75	50	25	-
½" Imperial Olive Compression Lockshield Angle Chrome - Republic of Ireland only	ANG1	73	60	22	-	-	-	75	50	25	-
½" Imperial Olive Compression Lockshield Angle Chrome Drain Off - Republic of Ireland only	DRA1	102	60	22	-	-	-	75	50	25	-
½" Imperial Olive Compression Wheelhead Straight Chrome - Republic of Ireland only	STR1	83	56	31	-	-	27	67	54	13	-
½" Imperial Olive Compression Lockshield Straight Chrome - Republic of Ireland only	STR1	83	56	22	-	-	27	67	54	13	-
10mm Wheelhead Angle Chrome	ANG1	76	60	31	-	-	-	75	50	25	-
10mm Lockshield Angle Chrome	ANG1	72	60	22	-	-	-	75	50	25	-
10mm Lockshield Angle Chrome C/W Compression 90° Elbow	ANG3	73	60	22	30	30	-	107	50	57	46
10mm Lockshield Angle Chrome Drain Off	DRA1	102	60	22	-	-	42	77	50	27	-
10mm Wheelhead Angle Chrome C/W Compression 90° Elbow	ANG3	73	60	31	30	30	-	107	50	27	46
10mm Lockshield Angle Chrome Drain Off C/W Compression 90° Elbow	DRA3	102	60	22	30	30	42	107	50	27	46
15mm Wheelhead Angle Chrome	ANG1	76	60	31	-	-	-	75	50	25	-
15mm Lockshield Angle Chrome	ANG1	73	60	22	-	-	-	75	50	25	-
15mm Lockshield Angle Chrome Drain Off	DRA1	102	60	22	-	-	42	75	50	25	-
15mm Wheelhead Straight Chrome	STR1	83	56	31	-	-	27	67	54	13	-
15mm Lockshield Straight Chrome	STR1	83	56	22	-	-	27	67	54	13	-
MATCHMATE PUSHFIT											
10mm Wheelhead Angle Chrome C/W Pushfit 90° Elbow	ANG3	76	60	31	28	32	-	104	50	54	45
10mm Lockshield Angle Chrome C/W Pushfit 90° Elbow	ANG3	73	60	22	28	32	-	104	50	54	45
10mm Lockshield Angle Chrome Drain Off C/W Pushfit 90° Elbow	DRA3	102	60	22	28	32	42	104	50	54	45
10mm Lockshield Angle Chrome Drain Off Pushfit	DRA2	102	60	22	-	-	42	95	50	45	-
10mm Wheelhead Angle Chrome Pushfit	ANG2	76	60	31	-	-	-	95	50	45	-
10mm Lockshield Angle Chrome Pushfit	ANG2	73	60	22	-	-	-	95	50	45	-
10mm Lockshield Straight Chrome Pushfit	STR2	104	60	22	-	-	48	67	54	13	-
15mm Wheelhead Angle Chrome C/W Pushfit 90° Elbow	ANG3	76	60	31	35	25	-	112	50	62	50
15mm Lockshield Angle Chrome C/W Pushfit 90° Elbow	ANG3	73	60	22	35	25	-	112	50	62	50
15mm Lockshield Angle Chrome Drain Off C/W Pushfit 90° Elbow	DRA3	102	60	22	35	25	42	112	50	62	50
15mm Wheelhead Angle Chrome Pushfit	ANG2	76	60	31	-	-	-	108	50	59	-
15mm Lockshield Angle Chrome Pushfit	ANG2	73	60	22	-	-	-	108	50	58	-

NB: All measurements are nominal.

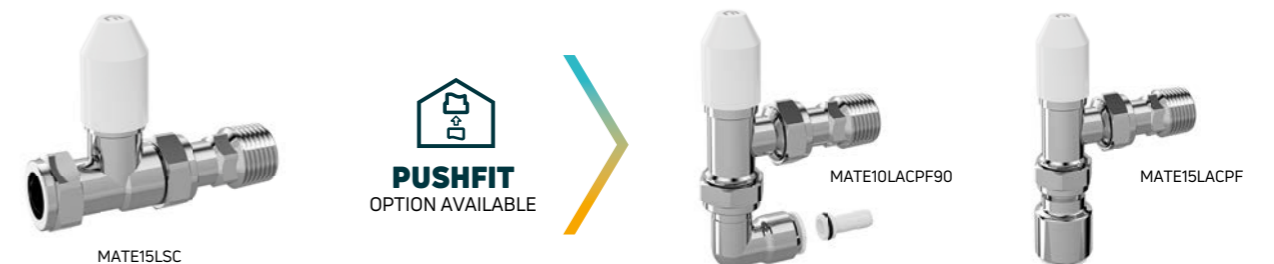

MATCHMASTER

MATCHMASTER is a high-quality range of chrome finish heating valves, making them ideal for when a more robust specification is required. The valve uses a graphite gland packing which can be easily compressed by tightening the gland nut to ensure many years of trouble-free operation. There is a wide choice of compression and pushfit connections, as well as drain off options. Straight and angled options are also available.



MASTER15WAC

General specification

CERTIFICATION
Produced under a quality management system - ISO 9001:2008. Conforms to BS 2767-10.

GUARANTEE
2 year guarantee from date of purchase against manufacturing defects.

COLOUR
Finished in chrome.

CONNECTIONS
Compression and pushfit.

OPERATING PRESSURES
Operating pressure 10 bar (compression) and 3 bar (pushfit).

OPERATING TEMPERATURE
Operating temperature 120°C (compression) and 92°C (pushfit).

DELIVERY
2 - 5 working days.

For more general information, please see page 264.

MATCHMASTER compression

Description	Colour (Top)	Wheel Head Order Code	Lockshield Order Code	Minimum Order Qty
½" Imperial Olive Compression Angle Chrome - Republic of Ireland only	White	MASTER1/2WAC	MASTER1/2LAC	10
½" Imperial Olive Compression Straight Chrome - Republic of Ireland only	White	MASTER1/2WSC	MASTER1/2LSC	10
10mm Angle Chrome	White	MASTER10WAC	MASTER10LAC	10
10mm Angle Chrome Drain Off	White	-	MASTER10LACD	10
15mm Angle Chrome	White	MASTER15WAC	MASTER15LAC	10
15mm Angle Chrome Drain Off	White	-	MASTER15LACD	10
15mm Straight Chrome	White	MASTER15WSC	MASTER15LSC	10
15mm or ½" BSP Angle Chrome	White	MASTER151/2WAC	MASTER151/2LAC	10
15mm or ½" BSP Straight Chrome	White	MASTER151/2WSC	MASTER151/2LSC	10

MATCHMASTER pushfit

Description	Colour (Top)	Wheel Head Order Code	Lockshield Order Code	Minimum Order Qty
10mm Angle Chrome C/W Pushfit 90° Elbow	White	MASTER10WACPF90	MASTER10LACPF90	10
10mm Angle Chrome Drain Off C/W Pushfit 90° Elbow	White	-	MASTER10LACDPF90	10
10mm Angle Chrome Pushfit	White	MASTER10WACPF	MASTER10LACPF	10
10mm Straight Chrome Pushfit	White	-	MASTER10LSCPF	10
10mm Straight Chrome Pushfit 90° Elbow	White	MASTER10WSCPF90	MASTER10LSCPF90	10
15mm Angle Chrome C/W Pushfit 90° Elbow	White	-	MASTER15LACPF90	10
15mm Angle Chrome Drain Off C/W Pushfit 90° Elbow	White	-	MASTER15LACDPF90	10
15mm Angle Chrome Drain Off Pushfit	White	-	MASTER15LACDPF	10
15mm Straight Chrome C/W Pushfit 90° Elbow	White	-	MASTER15LSCPF90	10

MATCHMASTER accessories

Description	Colour (Top)	Wheel Head Order Code	Lockshield Order Code	Minimum Order Qty
MATCHMASTER Top Only	White	MASTERWHTOP	MASTERLSTOP	10

Technical information

Dimensions

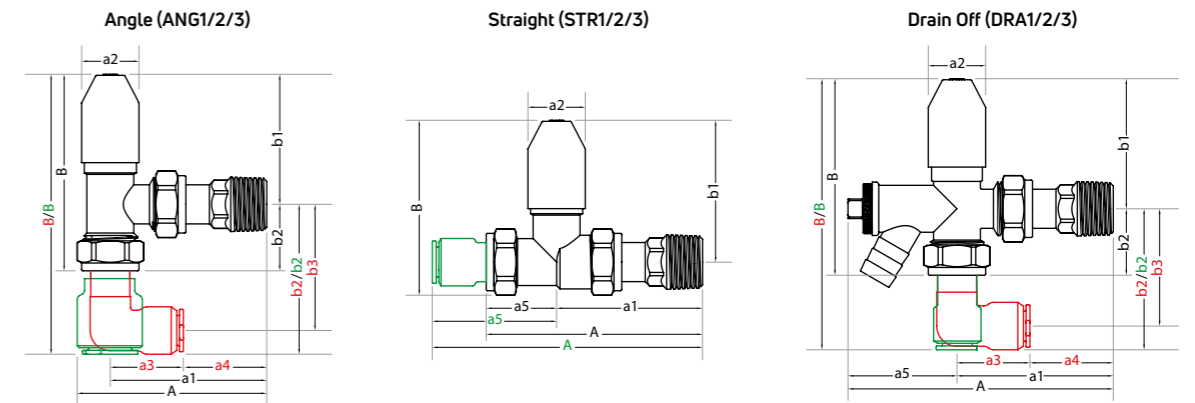

DRAWING REFERENCE: 1 = Standard (Black); 2 = Pushfit (Green & Black); 3 = Pushfit 90° Elbow (Red & Black). Drawings for illustration purposes only.

Model	DWG Ref.	A (mm)	a1 (mm)	a2 (mm)	a3 (mm)	a4 (mm)	a5 (mm)	B (mm)	b1 (mm)	b2 (mm)	b3 (mm)
MATCHMASTER											
½" Imperial Olive Compression Lockshield Angle Chrome - Republic of Ireland only	ANG1	73	60	27	-	-	-	77	49	28	-
½" Imperial Olive Compression Wheelhead Angle Chrome - Republic of Ireland only	ANG1	79	60	37	-	-	-	81	53	28	-
½" Imperial Olive Compression Lockshield Straight Chrome - Republic of Ireland only	STR1	92	60	27	-	-	32	70	57	13	-
½" Imperial Olive Compression Wheelhead Straight Chrome - Republic of Ireland only	STR1	92	60	37	-	-	32	77	64	13	-
10mm Lockshield Angle Chrome	ANG1	73	60	27	-	-	-	79	49	30	-
10mm Wheelhead Angle Chrome	ANG1	79	60	37	-	-	-	83	53	30	-
10mm Lockshield Angle Chrome Drain Off	DRA1	88	75	27	-	-	-	79	49	30	-
15mm Lockshield Angle Chrome	ANG1	73	60	27	-	-	-	77	49	28	-
15mm Wheelhead Angle Chrome	ANG1	79	60	37	-	-	-	81	53	28	-
15mm Lockshield Angle Chrome Drain Off	DRA1	88	75	27	-	-	-	77	49	28	-
15mm Lockshield Straight Chrome	STR1	92	60	27	-	-	32	70	57	13	-
15mm Wheelhead Straight Chrome	STR1	92	60	37	-	-	32	77	64	13	-
15mm or ½" BSP Lockshield Angle Chrome	ANG1	75	60	27	-	-	-	85	49	36	-
15mm or ½" BSP Wheelhead Angle Chrome	ANG1	79	60	37	-	-	-	89	53	36	-
15mm or ½" BSP Lockshield Straight Chrome	STR1	99	60	27	-	-	39	72	58	14	-
15mm or ½" BSP Wheelhead Straight Chrome	STR1	99	60	37	-	-	39	79	65	14	-
MATCHMASTER PUSHFIT											
10mm Lockshield Angle Chrome C/W Pushfit 90° Elbow	ANG3	73	60	27	28	32	-	107	49	58	49
10mm Wheelhead Angle Chrome C/W Pushfit 90° Elbow	ANG3	79	60	37	28	32	-	107	49	58	49
10mm Lockshield Angle Chrome Drain Off C/W Pushfit 90° Elbow	DRA3	88	75	27	28	47	41	107	49	58	49
10mm Lockshield Angle Chrome Pushfit	ANG2	73	60	27	-	-	-	96	49	47	-
10mm Wheelhead Angle Chrome Pushfit	ANG2	79	60	37	-	-	-	100	53	47	-
10mm Lockshield Straight Chrome Pushfit	STR2	111	60	27	-	-	51	70	57	-	-
10mm Wheelhead Straight Chrome 90° Elbow	STR3	111	60	37	-	-	51	76	64	-	-
10mm Lockshield Straight Chrome Pushfit 90° Elbow	STR3	116	60	27	28	-	56	85	57	-	-
15mm Lockshield Angle Chrome C/W Pushfit 90° Elbow	ANG3	73	60	27	35	26	-	116	49	67	-
15mm Lockshield Angle Chrome Drain Off C/W Pushfit 90° Elbow	DRA3	88	75	27	35	41	41	116	49	67	55
15mm Lockshield Angle Chrome Drain Off Pushfit	DRA2	76	60	27	-	-	-	108	50	58	-
15mm Lockshield Straight Chrome C/W Pushfit 90° Elbow	STR3	116	60	27	-	-	56	108	50	58	-

NB: All measurements are nominal



MASTER15LAC



MASTER15LSC



MASTER10LSCPF90

FULLFLOW

FULLFLOW radiator valves are designed and manufactured to meet the requirements of commercial installations. They feature a non-rising spindle, double EPDM 'O' ring gland seals with an additional 'O' ring back seating arrangement, this enables the FULLFLOW valve to be serviced without the requirement for draining the system, perfect for commercial applications. The range includes compression and screwed iron connections. Straight and angle versions are also available. Product is only available in polished chrome.



FF1512WAC

Technical information

Dimensions

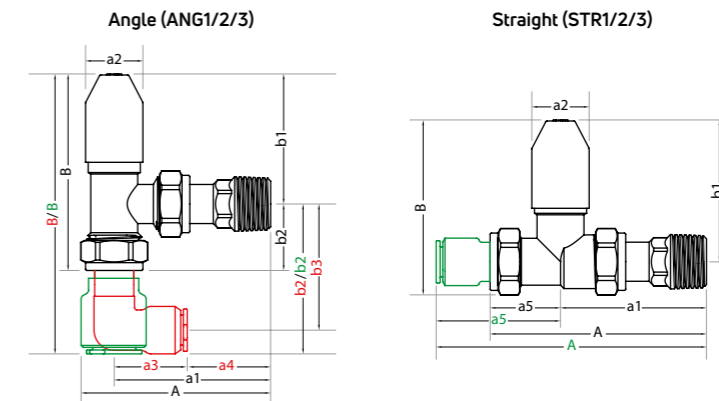

DRAWING REFERENCE: 1 = Standard (Black); 2 = Pushfit (Green & Black); 3 = Pushfit 90° Elbow (Red & Black). Drawings for illustration purposes only.

Model	DWG Ref.	A (mm)	a1 (mm)	a2 (mm)	B (mm)	b1 (mm)	b2 (mm)
FULLFLOW							
15mm / 1/2" Copper or 1/2" BSP Lockshield Angle Polished Chrome	ANG1	75	57	36	90	52	38
15mm / 1/2" Copper or 1/2" BSP Lockshield Straight Polished Chrome	STR1	96	57	36	75	61	14
15mm / 1/2" Copper or 1/2" BSP Wheelhead Angle Polished Chrome	ANG1	78	57	42	95	57	38
15mm / 1/2" Copper or 1/2" BSP Wheelhead Straight Polished Chrome	STR1	96	57	42	80	66	14

NB: All measurements are nominal.

General specification

- CERTIFICATION**
Produced under a quality management system - ISO 9001:2008. Conforms to BS 2767-10.
- GUARANTEE**
2 year guarantee from date of purchase against manufacturing defects.
- COLOUR**
Finished in polished chrome.
- CONNECTIONS**
Compression and screwed iron.
- OPERATING PRESSURES**
Operating pressure 10 bar.
- OPERATING TEMPERATURE**
Operating temperature 120°C.
- DELIVERY**
2 - 5 working days.



FF1512LAC

For more general information, please see page 264.

FULLFLOW

Description	Colour (Top)	Order Code	Minimum Order Qty
15mm / 1/2" Copper or 1/2" BSP Lockshield Angle Polished Chrome	White	FF151/2LAC	10
15mm / 1/2" Copper or 1/2" BSP Lockshield Straight Polished Chrome	White	FF151/2LSC	10
15mm / 1/2" Copper or 1/2" BSP Wheelhead Angle Polished Chrome	White	FF151/2WAC	10
15mm / 1/2" Copper or 1/2" BSP Wheelhead Straight Polished Chrome	White	FF151/2WSC	10

FULLFLOW accessories

FULLFLOW Lockshield & Wheelhead Tops Only	White	FFLSWHTOPS	10
---	-------	------------	----



DECORATIVE

TRV

MYSON offer a selection of polished chrome DECORATIVE TRV valves for projects that need that extra special finishing touch with thermostatic control. The range includes compression and pushfit connections, with straight and angle options available.



DECTR15AC

General specification

CERTIFICATION
Produced under a quality management system - ISO 9001:2008. Conforms to BS 2767-10.

GUARANTEE
2 year guarantee from date of purchase against manufacturing defects.

COLOUR
Finished in polished chrome.

CONNECTIONS
Compression and pushfit.

OPERATING PRESSURES
Operating pressure 10 bar (compression) and 3 bar (pushfit).

OPERATING TEMPERATURE
Operating temperature 120°C (compression) and 92°C (pushfit).

DELIVERY
2 - 5 working days.

For more general information, please see page 264.

Technical information

Dimensions

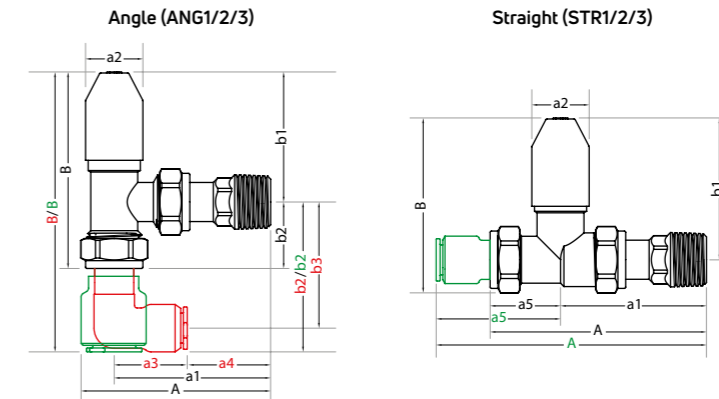

DRAWING REFERENCE: 1 = Standard (Black); 2 = Pushfit (Green & Black); 3 = Pushfit 90° Elbow (Red & Black). Drawings for illustration purposes only.

Model	DWG Ref.	A (mm)	a1 (mm)	a2 (mm)	a3 (mm)	a4 (mm)	a5 (mm)	B (mm)	b1 (mm)	b2 (mm)	b3 (mm)
DECORATIVE											
15mm TRV Angle Polished Chrome	ANG1	86	62	49	-	-	-	133	104	29	-
15mm TRV Straight Polished Chrome	STR1	98	62	49	-	-	36	120	108	-	-
DECORATIVE PUSHFIT											
10mm TRV Angle Polished Chrome C/W Pushfit 90° Elbow	ANG3	86	62	49	28	34	-	158	104	54	45
10mm TRV Straight Polished Chrome C/W Pushfit 90° Elbow	STR3	124	62	49	28	-	62	136	108	28	53
15mm TRV Angle Polished Chrome C/W Pushfit 90° Elbow	ANG3	86	62	49	35	28	-	167	104	63	50
15mm TRV Straight Polished Chrome C/W Pushfit 90° Elbow	STR3	130	62	49	35	-	68	142	108	35	55
DECORATIVE ACCESSORIES											
15mm TRV Angle Polished Chrome Body Only	ANG1	80	62	35	-	-	-	64	35	29	-
15mm TRV Straight Polished Chrome Body Only	STR1	98	62	35	-	-	36	52	39	13	-

NB: All measurements are nominal.

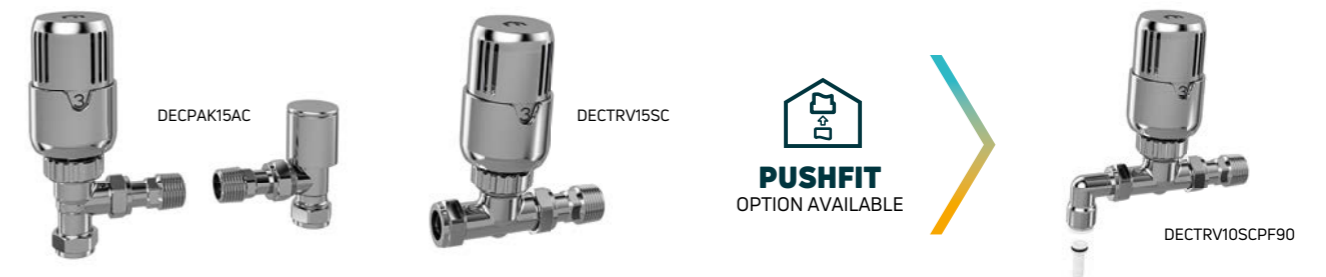

DECORATIVE

Description	Colour (Top)	Order Code	Minimum Order Qty
15mm TRV Angle Polished Chrome	Polished Chrome	DECTR15AC	1
15mm TRV Straight Polished Chrome	Polished Chrome	DECTR15SC	1

DECORATIVE pushfit

10mm TRV Angle Polished Chrome C/W Pushfit 90° Elbow	Polished Chrome	DECTR10ACPF90	1
10mm TRV Straight Polished Chrome C/W Pushfit 90° Elbow	Polished Chrome	DECTR10SCPF90	1
15mm TRV Angle Polished Chrome C/W Pushfit 90° Elbow	Polished Chrome	DECTR15ACPF90	1
15mm TRV Straight Polished Chrome C/W Pushfit 90° Elbow	Polished Chrome	DECTR15SCPF90	1

DECORATIVE pack

Radpack 15mm TRV & Lockshield Pack Angle Polished Chrome	Polished Chrome	DECPAK15AC	1
Radpack 15mm TRV & Lockshield Pack Straight Polished Chrome	Polished Chrome	DECPAK15SC	1

DECORATIVE accessories

15mm TRV Angle Polished Chrome Body Only	Polished Chrome	DECTR15ACBODY	1
15mm TRV Straight Polished Chrome Body Only	Polished Chrome	DECTR15SCBODY	1
Decorative Thermostatic Head Only Chrome	Polished Chrome	DECTRHEADC	1
Electronic Thermostatic Head (ETH) - see page 247	White	UNIPLETH	1

Electronic Thermostatic Head (ETH)

The MYSON Electronic Thermostatic Head (ETH) is suitable for all MYSON TRV bodies. Easy cloud-based control via an intuitive app turns it into a smart TRV, controllable on a smartphone or tablet - see page 247.

Order Code: UNIPLETH



DECORATIVE

Slimline, Modern & Traditional

MYSON offer a selection of DECORATIVE manual valves for projects that need that extra special finishing touch as they are beautifully finished in highly polished chrome. The range includes compression and pushfit connections, with straight and angle options available.

DECORATIVE manual valves are offered in three styles; Slimline, Modern & Traditional.



DEC_10LWACSLIM - SLIMLINE

General specification

CERTIFICATION
Produced under a quality management system - ISO 9001:2008. Conforms to BS 2767-10.

OPERATING PRESSURES
Operating pressure 10 bar (compression) and 3 bar (pushfit).

GUARANTEE
2 year guarantee from date of purchase against manufacturing defects.

OPERATING TEMPERATURE
Operating temperature 120°C (compression) and 92°C (pushfit).

COLOUR
Finished in polished chrome.

DELIVERY
2 - 5 working days.

CONNECTIONS
Compression and pushfit.



DEC15LWACTRAD - TRADITIONAL

For more general information, please see page 264.

DECORATIVE

Description	Colour (Top)	Order Code	Minimum Order Qty
15mm Lockshield or Wheelhead Angle Polished Chrome - Slimline	Polished Chrome	DEC15LWACSLIM	1
15mm Lockshield or Wheelhead Straight Polished Chrome - Slimline	Polished Chrome	DEC15LWSCSLIM	1
15mm Lockshield or Wheelhead Angle Polished Chrome - Modern	Polished Chrome	DEC15LWAC	1
15mm Lockshield or Wheelhead Straight Polished Chrome - Modern	Polished Chrome	DEC15LWSC	1
15mm Lockshield or Wheelhead Angle Polished Chrome - Traditional	Polished Chrome	DEC15LWACTRAD	1
15mm Lockshield or Wheelhead Straight Polished Chrome - Traditional	Polished Chrome	DEC15LWSCTRAD	1

DECORATIVE pushfit

10mm Lockshield or Wheelhead Angle Polished Chrome C/W Pushfit 90° Elbow - Modern	Polished Chrome	DEC10LWACPF90	1
10mm Lockshield or Wheelhead Straight Polished Chrome C/W Pushfit 90° Elbow - Modern	Polished Chrome	DEC10LWSCPF90	1
15mm Lockshield or Wheelhead Angle Polished Chrome C/W Pushfit 90° Elbow - Modern	Polished Chrome	DEC15LWACPF90	1
15mm Lockshield or Wheelhead Straight Polished Chrome C/W Pushfit 90° Elbow - Modern	Polished Chrome	DEC15LWSCPF90	1

Technical information

Dimensions

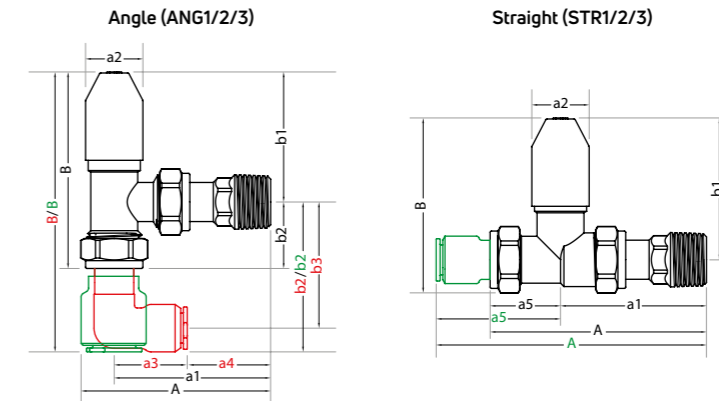

DRAWING REFERENCE: 1 = Standard (Black); 2 = Pushfit (Green & Black); 3 = Pushfit 90° Elbow (Red & Black). Drawings for illustration purposes only.

Model	DWG Ref.	A (mm)	a1 (mm)	a2 (mm)	a3 (mm)	a4 (mm)	a5 (mm)	B (mm)	b1 (mm)	b2 (mm)	b3 (mm)
DECORATIVE											
15mm Lockshield or Wheelhead Angle Polished Chrome - Slimline	ANG1	75	60	31	-	-	-	72	44	28	-
15mm Lockshield or Wheelhead Straight Polished Chrome - Slimline	STR1	95	60	31	-	-	35	67	55	12	-
15mm Lockshield or Wheelhead Angle Polished Chrome - Modern	ANG1	70	55	31	-	-	-	88	54	34	-
15mm Lockshield or Wheelhead Straight Polished Chrome - Modern	STR1	85	53	31	-	-	32	73	57	16	-
15mm Lockshield or Wheelhead Angle Polished Chrome - Traditional	ANG1	86	55	63	-	-	-	111	77	34	-
15mm Lockshield or Wheelhead Straight Polished Chrome - Traditional	STR1	87	51	63	-	-	36	97	80	17	-
DECORATIVE PUSHFIT											
10mm Lockshield or Wheelhead Angle Polished Chrome C/W Pushfit 90° Elbow - Modern	ANG3	70	55	31	30	25	-	110	54	56	47
10mm Lockshield or Wheelhead Straight Polished Chrome C/W Pushfit 90° Elbow - Modern	STR3	106	51	31	-	-	55	86	57	29	-
15mm Lockshield or Wheelhead Angle Polished Chrome C/W Pushfit 90° Elbow - Modern	ANG3	70	55	31	34	21	-	119	54	65	52
15mm Lockshield or Wheelhead Straight Polished Chrome C/W Pushfit 90° Elbow - Modern	STR3	116	51	31	-	-	65	91	57	-	-

NB: All measurements are nominal.

Modern



DEC15LWSC

PUSHFIT
OPTION AVAILABLE



DEC10LWACPF90

Slimline



DEC15LWSCSLIM

Traditional



DEC15LWSCTRAD

TRV2

The MYSON TRV2 is the most complete thermostatic radiator valve range available for today's central heating systems. The MYSON TRV2 simplifies installation and removes the worry of costly call-backs. It has a liquid sensor fitted at its heart, guaranteeing years of accurate temperature control. It is available with a chrome finish, compression and pushfit connections as well as straight and angled variants.



TRV215AC

TRV2 compression



Description	Colour (Top)	Order Code	Minimum Order Qty
1/2" Imperial Olive Compression Angle Chrome - Republic of Ireland only	White	TRV21/2AC	1
1/2" Imperial Olive Compression Straight Chrome - Republic of Ireland only	White	TRV21/2SC	1
10mm TRV Angle Chrome	White	TRV210AC	1
10mm TRV Angle Chrome C/W Compression 90° Elbow	White	TRV210AC90	1
10mm TRV Straight Chrome	White	TRV210SC	1
15mm TRV Angle Chrome	White	TRV215AC	1
15mm TRV Straight Chrome	White	TRV215SC	1
8/10/15mm TRV Angle Chrome	White	TRV28/10/15AC	1

TRV2 pushfit



10mm TRV Angle Chrome C/W Pushfit 90° Elbow	White	TRV210ACPF90	1
10mm TRV Angle Chrome Pushfit	White	TRV210ACPF	1
10mm TRV Straight Chrome C/W Pushfit 90° Elbow	White	TRV210SCPF90	1
10mm TRV Straight Chrome Pushfit	White	TRV210SCPF	1
15mm TRV Angle Chrome C/W Pushfit 90° Elbow	White	TRV215ACPF90	1
15mm TRV Angle Chrome Pushfit	White	TRV215ACPF	1
15mm TRV Straight Chrome C/W Pushfit 90° Elbow	White	TRV215SCPF90	1

TRV2 pack compression & BSP



Radpack 1/2" Imperial Olive Compression or 1/2" BSP TRV2 & MATCHMASTER Lockshield Pack Angle Chrome	White	TRV2PAK1/2AC	1
Radpack 10/15mm TRV2 & MATCHMASTER Lockshield Pack Angle Chrome	White	TRV2PAK10/15AC	1
Radpack 15mm TRV2 & MATCHMATE Lockshield Pack Angle Chrome	White	TRV2PAK15AC	10

TRV2 pushfit pack



Radpack 10mm TRV2 & MATCHMATE Lockshield Pack Angle Chrome C/W Pushfit 90° Elbow	White	TRV2PAK10ACPF90	10
Radpack 10mm TRV2 & MATCHMATE Lockshield Pack Angle Chrome Pushfit	White	TRV2PAK10ACPF	10
Radpack 15mm TRV2 & MATCHMATE Lockshield Pack Angle Chrome C/W Pushfit 90° Elbow	White	TRV2PAK15ACPF90	10
Radpack 15mm TRV2 & MATCHMATE Lockshield Pack Angle Chrome Pushfit	White	TRV2PAK15ACPF	10

TRV accessories

1/2" Imperial Olive Compression Angle Chrome Body Only - Republic of Ireland only	-	TRV1/2ACBODY	1
15mm or 1/2" BSP TRV Angle Chrome Body Only	-	TRV2151/2ACBODY	1
15mm or 1/2" BSP TRV Straight Chrome Body Only	-	TRV2151/2SCBODY	1
15mm TRV Angle Chrome Body Only	-	TRV215ACBODY	1
15mm TRV Straight Chrome Body Only	-	TRV215SCBODY	1
TRV Thermostatic Head Only White	White	TRV2TRVHEADW	1
Electronic Thermostatic Head (ETH) - see page 247	White	UNIPLETH	1

General specification



CERTIFICATION
Produced under a quality management system - ISO 9001:2008. Conforms to BS 2767-10 and complies to EN 215.



GUARANTEE
2 year guarantee from date of purchase against manufacturing defects.



COLOUR
Finished in chrome.



CONNECTIONS
Compression and pushfit.



OPERATING PRESSURES
Operating pressure 10 bar (compression) and 3 bar (pushfit).



OPERATING TEMPERATURE
Operating temperature 120°C (compression) and 92°C (pushfit).



DELIVERY
2 - 5 working days.

For more general information, please see page 264.

Technical information

Dimensions

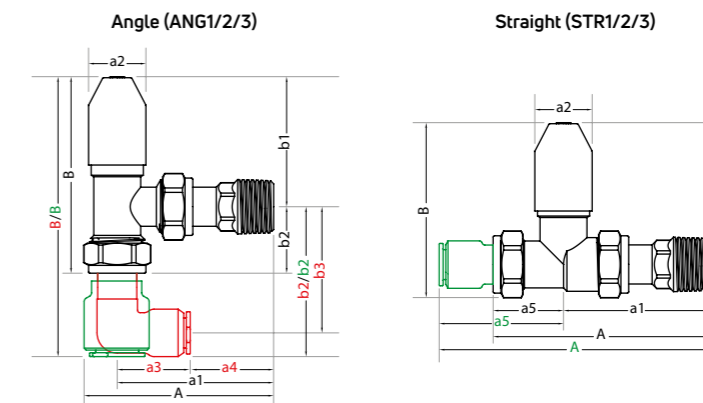

DRAWING REFERENCE: 1 = Standard (Black); 2 = Pushfit (Green & Black); 3 = Pushfit 90° Elbow (Red & Black). Drawings for illustration purposes only.

Model	DWG Ref.	A	a1	a2	a3	a4	a5	B	b1	b2	b3
		(mm)	(mm)	(mm)	(mm)	(mm)	(mm)	(mm)	(mm)	(mm)	(mm)
TRV2											
1/2" Imperial Olive Compression Angle Chrome - Republic of Ireland only	ANG1	85	62	45	-	-	-	141	112	29	-
1/2" Imperial Olive Compression Straight Chrome - Republic of Ireland only	STR1	103	67	45	-	-	36	124	112	12	-
10mm TRV Angle Chrome	ANG1	85	62	45	-	-	-	141	112	29	-
10mm TRV Angle Chrome C/W Compression 90° Elbow	STR3	85	62	45	30	32	-	168	112	56	45
10mm TRV Straight Chrome	STR1	103	67	45	-	-	36	124	112	12	-
15mm TRV Angle Chrome	ANG1	85	62	45	-	-	-	141	112	29	-
8/10/15mm TRV Angle Chrome	ANG1	85	62	45	-	-	-	141	112	29	-
TRV2 PUSHFIT											
10mm TRV Angle Chrome C/W Pushfit 90° Elbow	ANG3	85	62	45	28	34	-	166	112	54	45
10mm TRV Angle Chrome Pushfit	ANG2	85	62	45	-	-	-	160	112	48	-
10mm TRV Straight Chrome C/W Pushfit 90° Elbow	STR3	127	67	45	-	-	60	140	112	28	-
10mm TRV Straight Chrome Pushfit	STR2	121	67	45	-	-	54	124	112	12	-
15mm TRV Angle Chrome C/W Pushfit 90° Elbow	ANG3	85	62	45	34	28	-	174	112	62	-
15mm TRV Angle Chrome Pushfit	ANG2	85	62	45	-	-	-	171	112	59	-
15mm TRV Straight Chrome C/W Pushfit 90° Elbow	STR3	138	67	45	-	-	71	146	112	34	-
TRV2 ACCESSORIES											
15mm TRV Angle Chrome Body Only	ANG1	80	62	35	-	-	-	64	35	29	-
15mm TRV Straight Chrome Body Only	STR1	103	67	35	-	-	36	52	39	13	-

NB: All measurements are nominal.



TRV2PAK10/15AC



TRV215ACPF90



TRV215SCPF90



UNIPLETH

PETITE

The MYSON PETITE Thermostatic Radiator Valve is a beautifully designed TRV for today's heating systems. The PETITE combines attractive design with total reliability. It has a liquid sensor fitted at its heart, guaranteeing years of accurate temperature control. The PETITE is available as a single valve or a convenient 'TRV & manual' valve pack, in either 10mm or 15mm sizes with a chrome finish. The range includes compression and pushfit connections, with straight and angle options available.



General specification

CERTIFICATION
Produced under a quality management system - ISO 9001:2008 and complies to EN 215.

GUARANTEE
2 year guarantee from date of purchase against manufacturing defects.

COLOUR
Finished in chrome.

CONNECTIONS
Compression and pushfit.

OPERATING PRESSURES
Operating pressure 10 bar (compression) and 3 bar (pushfit).

OPERATING TEMPERATURE
Operating temperature 120°C (compression) and 92°C (pushfit).

DELIVERY
2 - 5 working days.

For more general information, please see page 264.

PETITE compression

Description	Colour (Top)	Order Code	Minimum Order Qty
10mm TRV Angle Chrome	White	PETTRV10AC	10
15mm TRV Angle Chrome	White	PETTRV15AC	10
15mm TRV Straight Chrome	White	PETTRV15SC	10

PETITE pushfit

10mm TRV Angle Chrome C/W Pushfit 90° Elbow	White	PETTRV10ACPF90	10
15mm TRV Angle Chrome C/W Pushfit 90° Elbow	White	PETTRV15ACPF90	10

PETITE pack

Radpack 1/2" Imperial Olive Compression PETITE TRV & MATCHMATE Lockshield Pack Angle Chrome - Republic of Ireland only	White	PETPAK1/2AC	10
Radpack 10mm PETITE TRV & MATCHMATE Lockshield Pack Angle Chrome	White	PETPAK10AC	10
Radpack 10mm PETITE TRV & MATCHMATE Lockshield Pack Angle Chrome Drain Off	White	PETPAK10ACD	10
Radpack 15mm PETITE TRV & MATCHMATE Lockshield Pack Angle Chrome	White	PETPAK15AC	10
Radpack 15mm PETITE TRV & MATCHMATE Lockshield Pack Angle Chrome Drain Off	White	PETPAK15ACD	10
Radpack 15mm PETITE TRV & MATCHMATE Lockshield Pack Straight Chrome	White	PETPAK15SC	10

PETITE pushfit pack

Radpack 10mm PETITE TRV & MATCHMATE Lockshield Pack Angle Chrome C/W Pushfit 90° Elbow	White	PETPAK10ACPF90	10
Radpack 10mm PETITE TRV & MATCHMATE Lockshield Pack Angle Chrome Drain Off C/W Pushfit 90° Elbow	White	PETPAK10ACDPF90	10

PETITE accessories

PETITE Thermostatic Head Only White	White	PETTRVHEADW	1
Electronic Thermostatic Head (ETH) - see page 247	White	UNIPLETH	1

Technical information

Dimensions

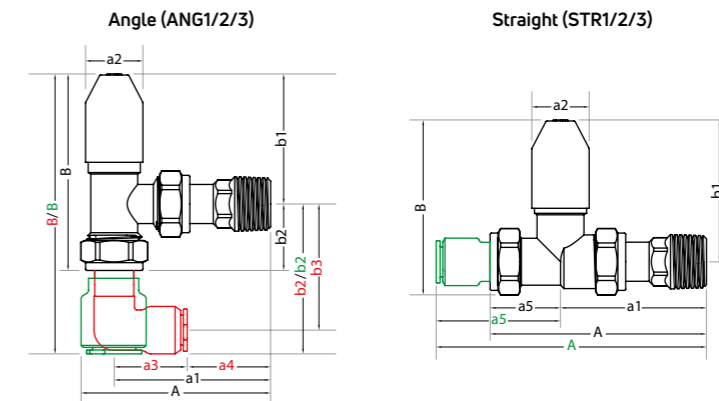

DRAWING REFERENCE: 1 = Standard (Black); 2 = Pushfit (Green & Black); 3 = Pushfit 90° Elbow (Red & Black). Drawings for illustration purposes only.

Model	DWG Ref.	A (mm)	a1 (mm)	a2 (mm)	a3 (mm)	a4 (mm)	a5 (mm)	B (mm)	b1 (mm)	b2 (mm)	b3 (mm)
PETITE											
10mm TRV Angle Chrome	ANG1	86	62	49	-	-	-	130	101	29	-
15mm TRV Angle Chrome	ANG1	86	62	49	-	-	-	130	101	29	-
15mm TRV Straight Chrome	STR1	103	67	49	-	-	36	114	101	13	-
PETITE PUSHFIT											
10mm TRV Angle Chrome C/W Pushfit 90° Elbow	ANG3	86	62	49	28	34	-	155	101	54	45
15mm TRV Angle Chrome C/W Pushfit 90° Elbow	ANG3	86	62	49	34	28	-	164	101	63	50

NB: All measurements are nominal.

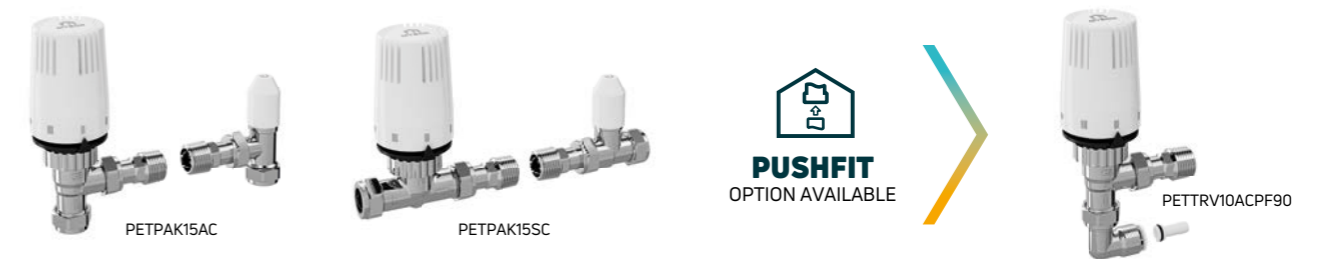

Electronic Thermostatic Head (ETH)

The MYSON Electronic Thermostatic Head (ETH) is suitable for all MYSON TRV bodies. Easy cloud-based control via an intuitive app turns it into a smart TRV, controllable on a smartphone or tablet - see page 247.

Order Code: UNIPLETH





MYSON PLUS

MYSON PLUS offers a simple but effective TRV valves with pushfit options and a chrome finish. The PLUS range is available in either 10mm or 15mm connections, in angled variant only, as well as a single version or pack which includes the MATCHMATE Lockshield.



PLUSTRV15AC

General specification

- CERTIFICATION**
Produced under a quality management system - ISO 9001:2008. Pressure tested in accordance with BS 2767.
- OPERATING PRESSURES**
Operating pressure 10 bar (compression) and 3 bar (pushfit).
- GUARANTEE**
2 year guarantee from date of purchase against manufacturing defects.
- OPERATING TEMPERATURE**
Operating temperature 120°C (compression) and 92°C (pushfit).
- COLOUR**
Finished in chrome.
- DELIVERY**
2 - 5 working days.
- CONNECTIONS**
Compression and pushfit.



PLUSPAK15AC

For more general information, please see page 264.

MYSON PLUS

Description	Colour (Top)	Order Code	Minimum Order Qty
10mm TRV Angle Chrome	White	PLUSTRV10AC	50
15mm TRV Angle Chrome	White	PLUSTRV15AC	50

MYSON PLUS pushfit



15mm TRV Angle Chrome Pushfit	White	PLUSTRV15ACPF	50
15mm Wheelhead Angle Chrome Pushfit	White	PLUS15WACPF	10
15mm Lockshield Angle Chrome Pushfit	White	PLUS15LACPF	10

MYSON PLUS pack

Radpack 10mm Plus TRV & MATCHMATE Lockshield Pack Angle Chrome	White	PLUSPAK10AC	50
Radpack 10mm Plus TRV & MATCHMATE Lockshield Pack Angle Chrome Drain Off	White	PLUSPAK10ACD	50
Radpack 15mm Plus TRV & MATCHMATE Lockshield Pack Angle Chrome	White	PLUSPAK15AC	50
Radpack 15mm Plus TRV & MATCHMATE Lockshield Pack Angle Chrome Drain Off	White	PLUSPAK15ACD	50

MYSON PLUS accessories

MYSON PLUS Thermostatic Head Only White	White	PLUSTRVHEADW	1
Electronic Thermostatic Head (ETH) - see page 247	White	UNIPLETH	1

Technical information

Dimensions

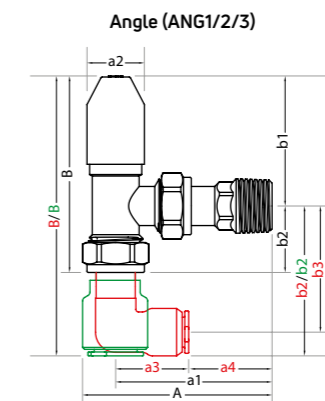

DRAWING REFERENCE: 1 = Standard (Black); 2 = Pushfit (Green & Black). Drawings for illustration purposes only.

Model	DWG Ref.	A (mm)	a1 (mm)	a2 (mm)	B (mm)	b1 (mm)	b2 (mm)
MYSON PLUS							
10mm TRV Angle Chrome	ANG1	86	62	49	130	101	29
15mm TRV Angle Chrome	ANG1	86	62	49	130	101	29
MYSON PLUS PUSHFIT							
15mm TRV Angle Chrome Pushfit	ANG2	86	62	49	135	101	34
15mm Wheelhead Angle Chrome Pushfit	ANG2	76	60	31	84	50	34
15mm Lockshield Angle Chrome Pushfit	ANG2	72	60	22	84	50	34

NB: All measurements are nominal.



PLUSPAK15ACD



PLUSTRV15ACPF



PLUS15LACPF

Electronic Thermostatic Head (ETH)

The MYSON Electronic Thermostatic Head (ETH) is suitable for all MYSON TRV bodies. Easy cloud-based control via an intuitive app turns it into a smart TRV, controllable on a smartphone or tablet - see page 247.

Order Code: UNIPLETH





LST TRV KITS

MYSON offer a flexible and comprehensive range of chrome TRV kits that are specifically designed to maximise the effectiveness of our range of LST radiators. For information on our LST range please see page 38.



Kits supplied with 'A' rated TRVs for energy efficiency

DIRECTFIT

We offer three designs, the Close Coupled Kit and the Universal Close Coupled Kit, which allows the case to be removed for cleaning without removing the TRV head, and the competitively priced Direct Fit Kit. All of the kits come with our A-rated TRV and are expertly designed for precision control.

The kits allow the thermal sensing head of a MYSON Thermostatic Radiator Valve to be mounted directly onto the LST enclosure of a MYSON Low Surface Temperature Radiators. They also feature a locking facility that prevents unauthorised adjustment in public areas.

General specification

CERTIFICATION
Produced under a quality management system - ISO 9001:2008. Manual valve conforms to BS 2767-10 and TRV complies to EN 215-1.

GUARANTEE
2 year guarantee from date of purchase against manufacturing defects.

COLOUR
Finished in chrome.

CONNECTIONS
Compression and screwed iron (direct fit only).

OPERATING PRESSURES
Operating pressure 10 bar (compression).

OPERATING TEMPERATURE
Operating temperature 120°C (compression).

DELIVERY
2 - 5 working days.

For more general information, please see page 264.

Direct fit TRV kit

Available for all LST's **except Vertical and 420mm wide**. Suitable for TBOE connection only. This kit allows a MYSON TRV to be mounted directly onto the internal radiator, making it an integral part of the LST radiator. This option utilises the 38mm knock out in the LST casing.

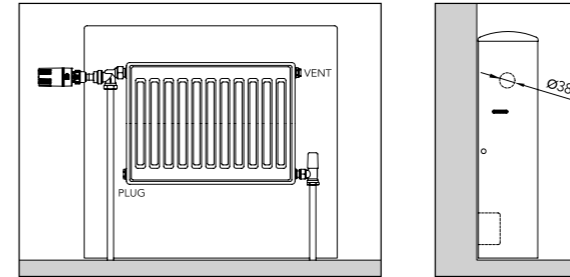

Direct Fit TRV Kit comprises:
1 x Horizontal angle TRV body
1 x TRV head
1 x Extension adaptor
1 x Plastic bush
1 x MATCHMASTER lockshield valve
Order Code: LSTDIRECTKITUK

Close coupled TRV kit

Available for all LST's **except Vertical and 420mm wide**. Suitable for TBOE, TBSE or BOE connections. This kit allows the MYSON TRV to be mounted directly onto the LST casing, with a choice of positions for both the TRV head and TRV angled valve body. This option utilises the 23mm knock out on the LST casing.

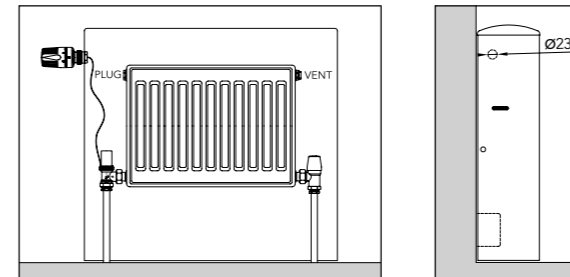

Close Coupled TRV Kit comprises:
1 x TRV head**
1 x TRV angled body**
1 x LST capillary unit/actuator/sensor head adaptor
1 x MATCHMASTER angled lockshield valve
1 x Locking tool
Order Code: LSTCCKITUK

Universal close coupled TRV kit†

Available for all LST's. Suitable for TBOE, TBSE or BOE connections. This kit allows the MYSON TRV to be mounted directly onto the LST casing, with a choice of positions for both the TRV head and TRV straight valve body. This option utilises the 23mm knock out on the LST casing.

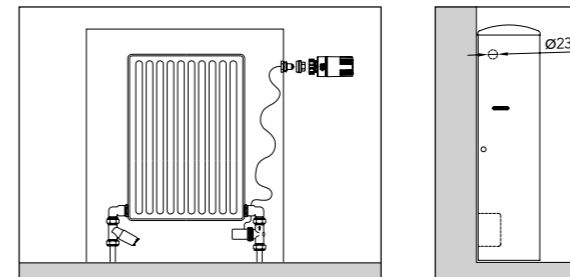

Universal Close Coupled TRV Kit Comprises:
1 x TRV head**
1 x TRV straight body**
1 x LST capillary unit/actuator/sensor head adaptor
1 x MATCHMASTER straight lockshield valve
2 x Integration elbows
Order Code: LSTUNIKITUK

†For LST Vertical instructions, please refer to page 45. **15mm compression copper only - for 1/2" iron pipe, an additional female adaptor is required.

LST TRV kits

Description	Colour (Top)	Order Code	Minimum Order Qty
Direct Fit Kit (1/2" Copper or 1/2" BSP) IRELAND Chrome*	White	LSTDIRECTKITIE	1
Direct Fit Kit (15mm Copper or 1/2" BSP) UK Chrome	White	LSTDIRECTKITUK	1
Universal Close Coupled Kit (1/2" Copper) IRELAND Chrome*	White	LSTUNIKITIE	1
Universal Close Coupled Kit (15mm Copper) UK Chrome	White	LSTUNIKITUK	1
Close Coupled Kit (1/2" Copper) IRELAND Chrome*	White	LSTCCKITIE	1
Close Coupled Kit (15mm Copper) UK Chrome	White	LSTCCKITUK	1

LST TRV kit accessories

Capillary Assembly - 2m	-	LSTCAP2	1
TRV Head Locating Body Chrome	White	LSTRVHLB	1

*ROI only.

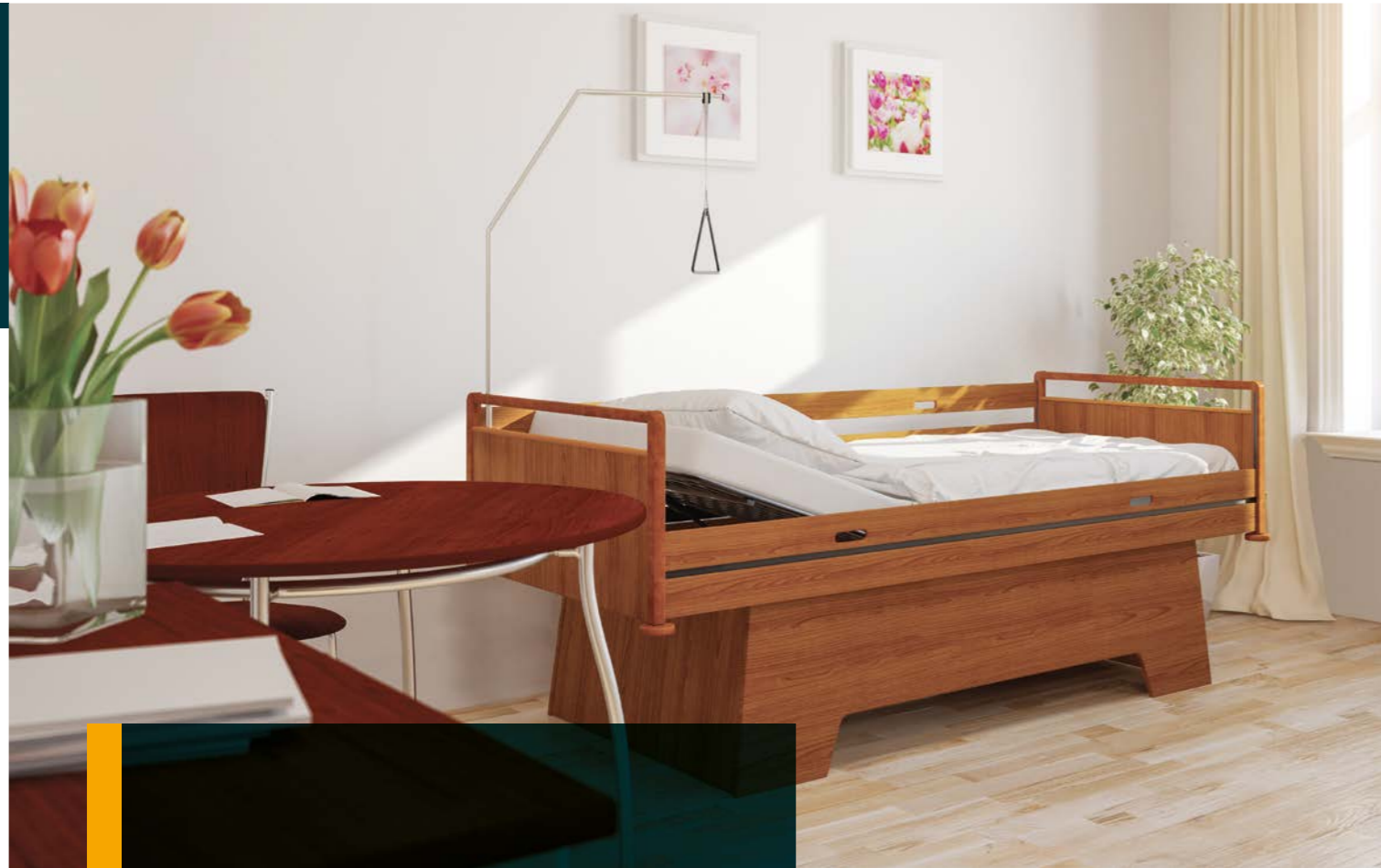

REMOTE THERMOSTATS

The MYSON remote sensor incorporates a traditional TRV head which can be set to the desired temperature.



The room temperature is monitored via a 2, or 5 metre capillary connected to the sensing element which can be mounted in a convenient and temperature representative area of the room. Remote sensor heads are ideal for use when it is difficult for a traditional TRV to operate, such as behind furniture or in direct sunlight, and are primarily used with LST radiators.

Dimensions

Remote Adjuster

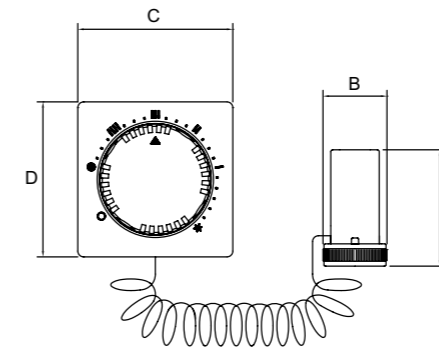

Remote Sensor

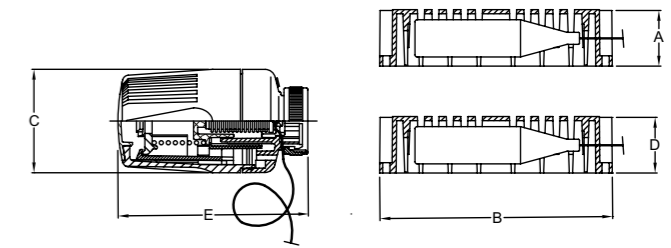

Model	A	B	C	D	E
	(mm)	(mm)	(mm)	(mm)	(mm)
REMOTE ADJUSTER					
2/5m Capillary	53.5	32.5	80.0	80.0	-
REMOTE SENSOR					
2/5m Capillary	28.0	112.0	50.0	28.0	90.0

NB: All measurements are nominal.

General specification

- CERTIFICATION**
Produced under a quality management system - ISO 9001:2008.
- GUARANTEE**
2 year guarantee from date of purchase against manufacturing defects.
- DELIVERY**
2 - 5 working days.

For more general information, please see page 264.



Description	Colour (Top)	Order Code	Minimum Order Qty
Remote Adjustable Head - 2m*	White	REMADJHEAD2	1
Remote Adjustable Head - 5m*	White	REMADJHEAD5	1
Remote Sensor Head - 2m*	White	REMSENHEAD2	1
Remote Sensor Head - 5m*	White	REMSENHEAD5	1

*Temporarily unavailable.

AUTOMATIC BYPASS VALVES

MYSON offer a selection of reliable Automatic Bypass Valves (ABVs).



ABV22A

Our automatic bypass valves are designed for use in domestic central heating systems and are available in either an angled or straight version. Its purpose is to maintain constant pump pressure and flow rate within the system. ABVs also reduce system noise and increase efficiency.

General specification

- CERTIFICATION**
Produced under a quality management system - ISO 9001:2008. Pressure tested in accordance with BS 2767.
 - OPERATING PRESSURES**
Operating pressure 10 bar.
 - OPERATING TEMPERATURE**
Operating temperature 120°C.
 - GUARANTEE**
2 year guarantee from date of purchase against manufacturing defects.
 - DELIVERY**
2 - 5 working days.
 - COLOUR**
Finished in nickel.
 - CONNECTIONS**
Compression.
- For more general information, please see page 264.

Dimensions

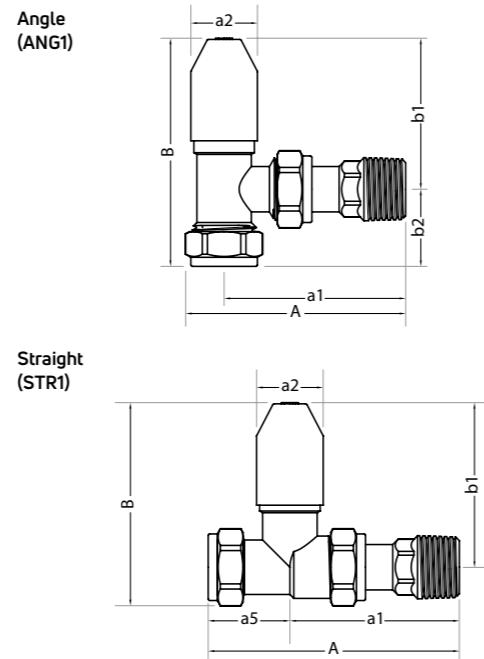

DRAWING REFERENCE: 1 = Standard.
Drawings for illustration purposes only.

Model	DWG Ref.	A (mm)	a1 (mm)	a2 (mm)	a5 (mm)	B (mm)	b1 (mm)	b2 (mm)
Automatic Bypass Valve 22mm Angle	ANG1	53	35	26	-	104	64	40
Automatic Bypass Valve 22mm Straight	STR1	77	39	26	38	94	76	-
Automatic Bypass Valve 3/4" Olive Angle	ANG1	53	35	26	-	104	64	40
Automatic Bypass Valve 3/4" Olive Straight	STR1	77	39	26	38	94	76	-

NB: All measurements are nominal.



ABV22S

Description	Colour (Top)	Order Code	Minimum Order Qty
Automatic Bypass Valve 22mm Angle	Black	ABV22A	1
Automatic Bypass Valve 22mm Straight	Black	ABV22S	1
Automatic Bypass Valves 3/4" Imperial Olive Compression Angle - Republic of Ireland only	Black	ABV3/4A	1
Automatic Bypass Valves 3/4" Imperial Olive Compression Straight - Republic of Ireland only	Black	ABV3/4S	1

HEATING VALVES

Accessories



CHRD/OTAIL

Description	Colour (Top)	Order Code	Minimum Order Qty
15mm - 10mm Pushfit Elbow Chrome	-	10MMPF90ELBOW	1
28mm - 30mm TRV Head Adaptor Chrome	-	TRV22830ADAP	1
Chrome Drain Off Tail	-	CHRD/OTAIL	1
Chrome Extension Tail - Standard (43mm)	-	CHREXTTAIL-STD	1
Chrome Extension Tail - Extended (64mm)	-	CHREXTTAIL-EXT	1
Chrome Radiator Extension - 20mm	-	CHRRADEXT-20	1
Chrome Radiator Extension - 30mm	-	CHRRADEXT-30	1
Chrome Radiator Extension - 40mm	-	CHRRADEXT-40	1
TRV Commissioning Cap	White	TRVCOMCAP	1



10MMPF90ELBOW



CHREXTTAIL-STD



CHRRADEXT-20



TRVCOMCAP

Electronic Thermostatic Head (ETH)

The MYSON Electronic Thermostatic Head (ETH) is suitable for all MYSON TRV bodies.

- Wireless ETH suitable for easy installation in new build and renovation
- Easy cloud-based control via an intuitive app turns it into a smart TRV
- Connectivity to smart home systems such as Alexa or Google Home
- In-app installation and diagnostics
- Standard 2 x AA batteries - battery life > 2 years
- Geo location - optional and flexible temperature management through presence detection

Installation options

- As a stand-alone device
- Pair with a UNISENZA PLUS Gateway for Smart App control
- Pair with a UNISENZA PLUS Gateway & Receiver RF for Smart App control that can turn on the heating source
- Pair with a UNISENZA PLUS Gateway, Receiver RF & Programmable Thermostat for Smart App control that can turn on the heating source

For more information on UNISENZA PLUS Controls see page 258.

Description	Colour (Top)	Order Code	Minimum Order Qty
Electronic Thermostatic Head (ETH)	White	UNIPLETH	1





Electronic controls

MYSON offers a full range of quality electronic controls to ensure that you get the most out of our heating products. Our controls are designed by our heating experts to perfectly complement our systems.

Controls are an essential part of every heating system. Today's controls should be easy to understand, operate and straightforward to install. Using the latest technologies, they should provide efficient, effective and precision control to meet the requirements of modern day, energy efficient homes.

MYSON's range of electronic controls provide many options, from mechanical dial thermostats to WiFi enabled touch controls utilising Smart Start technology, we have the solution for you.



UNISENZA DIAL
THERMOSTAT

UNISENZA dial thermostat is a wall mounted, temperature activated on/off switch.

UNISENZA DIAL

The desired temperature is set on the rotary control dial. The thermostat monitors and compares the actual room temperature with the set temperature on the control.

If the room temperature is below the desired level and the thermostat has requested heat, the central heating system will run the heating circuit until the temperature reaches the required level, the UNISENZA dial thermostat will switch off the heating circuit.

Product summary

- Silent operation
- Temperature range 5-30°C
- Surface mounted
- LED light displays system status (red=heating)
- Flat design with 30mm installation depth
- 230V

General specification

- GUARANTEE**
5 year guarantee from date of purchase against manufacturing defects.
- IP RATING**
IP20.
- DELIVERY**
2 - 5 working days.

For more general information, please see page 264.



Description	Order Code	Minimum Order Qty
UNISENZA Dial Thermostat	UNIDIAL	1



UNISENZA DIGITAL
THERMOSTAT

UNISENZA digital thermostat is a wall mounted slimline electronic thermostat for users that require greater accuracy of temperature control.

UNISENZA DIGITAL

It has a clear, accurate LCD display and limits the maximum and minimum temperature, working as either a heating control or a cooling control. It is ideal for upgrading an old two-wire (no neutral wire) thermostat and has volt free contacts for use with various types of system.

Product summary

- Silent operation and LCD display
- Temperature range 5-30°C
- Click-mounting on recessed connection unit
- Ultra-flat design, only 17mm deep
- 230V

General specification

- GUARANTEE**
5 year guarantee from date of purchase against manufacturing defects.
- IP RATING**
IP20.
- DELIVERY**
2 - 5 working days.

For more general information, please see page 264.





Description	Order Code	Minimum Order Qty
UNISENZA Digital Thermostat	UNIDIGITAL	1



This programmable WiFi thermostat enables easy set-up and control of the heating system on a smartphone or tablet via the UNISENZA app (no additional hub or gateway required). Smart Start function saves both energy and money by delaying the heating start up time when the weather is warmer.

General specification

-  **GUARANTEE**
5 year guarantee from date of purchase against manufacturing defects.
-  **IP RATING**
IP20.
-  **DELIVERY**
2 - 5 working days.

Product summary

- Silent operation and LCD display
- Temperature range 5-30°C
- Click-mounting on recessed connection unit
- Simple coupling with WLAN router for APP control (no additional hub or gateway required)
- Presence control possible through geolocation
- Ultra-flat design, only 17mm deep
- Online software update capability (OTA)
- Free UNISENZA app for Android and iOS
- 230v



For more general information, please see page 264.



Description	Order Code	Minimum Order Qty
UNISENZA WiFi Programmable Room Thermostat	UNIWiFi	1

It is used for monitoring and controlling the temperature of the hot water stored within the hot water cylinder. When used with a thermostatic control for the heating circuit it will give boiler interlock providing a safety feature. It can also be used as a pipe thermostat in conjunction with a frost thermostat to ensure a boiler does not run uncontrolled during cold weather.

General specification

-  **GUARANTEE**
2 year guarantee from date of purchase against manufacturing defects.
-  **IP RATING**
IP20.
-  **DELIVERY**
2 - 5 working days.

Product summary

- Maximum mounting temperature 100°C
- Operating range 10 to 90°C
- Switching differential 5 to 10°C
- Large terminal screws, for easy connection

For more general information, please see page 264.



Description	Order Code	Minimum Order Qty
Cylinder Thermostat	MCT1	1
Cylinder Thermostat - Anti-Tamper	MCT1TP	1



MPRT
PROGRAMMABLE ROOM THERMOSTAT

MPRT is an easy-to-use programmable room thermostat.

MPRT

It utilises Smart Start technology which can give the user considerable savings on heating bills by varying start-up times. The Smart Start system is continually learning the temperature rise requirement, delaying the start-up of the system, therefore saving energy during milder weather. A radio frequency version is also available.

Product summary

- Uses Smart Start technology
- 24-hour or 7-day programming
- 3 temperature settings - comfort, economy (set back) and frost
- 4 programmes (3 pre-set, 1 adjustable) with manual override
- Clear, accurate LCD display
- Compatible with MYSON FLOORTEC underfloor heating systems and connects to a 24V hard wired wiring centre. One thermostat can control several loops

General specification

- GUARANTEE**
2 year guarantee from date of purchase against manufacturing defects.
- IP RATING**
IP30.
- DELIVERY**
2 - 5 working days.
- BOILER PLUS COMPLIANT**

For more general information, please see page 264.



Description	Order Code	Minimum Order Qty
Programmable Room Thermostat	MPRT	1
Programmable Room Thermostat, Mains Supply	MPRTMS	1
Wireless Programmable Room Thermostat and Receiver	MPRTRF	1
RF Relay for use with the MPRTRF	RELAY433	1



TOUCH
PROGRAMMABLE ROOM THERMOSTAT

The MYSON TOUCH range of touch screen programmable thermostats allow you to set different room temperatures for the morning, day, evening and night time.

TOUCH

The Smart Start function will save both energy and money by delaying the heating start up time when the weather is warmer.

The range includes the MYSON TOUCH and MYSON TOUCH RS, which comes with a remote sensor. The TOUCH RS is primarily designed for underfloor systems which senses floor temperature.

Product summary

- Smart Start technology
- Clear, easy to use touch screen display
- 24-hour, 5/2 day or 7-day programming
- Up to 4 time and temperature settings per day
- 230V supply
- MYSON TOUCH is suitable to be classified as a "Delayed Start" thermostat as defined in SAP 2005
- MYSON TOUCH RS, primarily designed for underfloor systems, includes a remote sensor which senses either floor or room temperature or a combination of both
- Load Compensation technology (saves fuel by delaying heating 'start-up' on warm days)
- 2 zone programmable room thermostat

General specification

- GUARANTEE**
2 year guarantee from date of purchase against manufacturing defects.
- IP RATING**
IP20.
- DELIVERY**
2 - 5 working days.

For more general information, please see page 264.



Description	Order Code	Minimum Order Qty
TOUCH Screen Programmable Room Thermostat	TOUCH	1
TOUCH Screen Programmable Room Thermostat with Remote Sensor	TOUCHRS	1

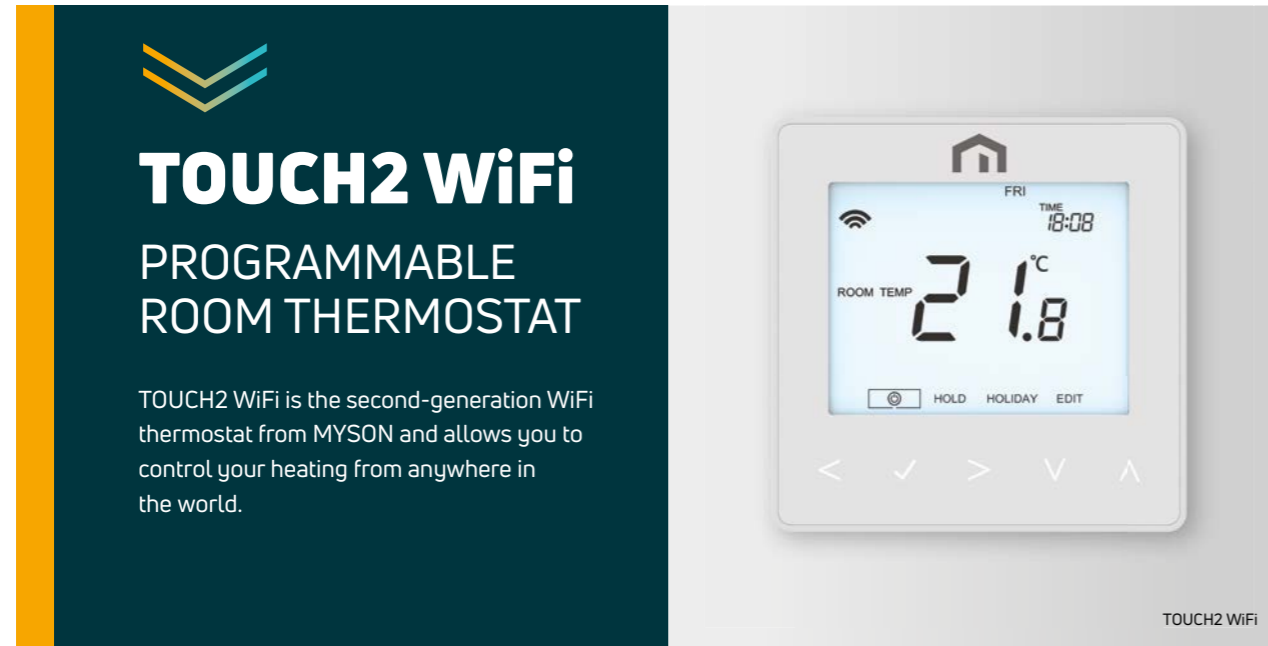

TOUCH2 WiFi

TOUCH2 WiFi

PROGRAMMABLE ROOM THERMOSTAT

TOUCH2 WiFi is the second-generation WiFi thermostat from MYSON and allows you to control your heating from anywhere in the world.

It is easy to set up and configure on your smart phone or tablet and is controlled using the TOUCH2 app. The Smart Start function will save both energy and money by delaying the heating start up time when the weather is warmer. The Geo Location feature will support multi-user smart phone to deactivate and reactivate when leaving and returning home.

- Compact size - 85mm x 85mm x 15mm and requires a minimum electrical box depth of 25mm
- Hub can control up to 32 thermostats
- 1 zone programmable room thermostat

General specification

- GUARANTEE**
2 year guarantee from date of purchase against manufacturing defects.
- IP RATING**
IP20.
- DELIVERY**
2 - 5 working days.
- BOILER PLUS COMPLIANT**
When connected to TOUCH2 Hub.

For more general information, please see page 264.

Product summary

- Apple HomeKit enabled
- Geo Location
- Smart Start technology
- Thimble air and floor sensor options
- 24-hour, 5/2 day or 7-day programming
- Up to 4 time and temperature period settings per day
- Can be set for time only (to control hot water cylinder)
- Temperature over-ride, temperature hold and holiday functions
- Lockable, with PIN code
- View live temperature from your home on your smart phone via the MYSON TOUCH2 app
- Uses mesh communication for multi-zone control



T2AHWIFI

Description	Order Code	Minimum Order Qty
TOUCH2 WiFi Touch Pad Programmable Room Thermostat for 'Smart Phone' Control & Control Hub	T2AHWIFI	1
TOUCH2 WiFi Touch Pad Programmable Room Thermostat for 'Smart Phone' Control	T2WIFI	1
TOUCH2 WiFi Hub Only	T2HUB	1
WiFi Air Sensor including Thimble Cover (2 metre cable)	TAIRSEN	1
WiFi Floor Sensor (3 metre cable)	TFLRSEN	1



TOUCH4

TOUCH4

PROGRAMMER

The MYSON TOUCH4 is a 4-zone programmer, designed to work perfectly with our electric radiator ranges (FINESSE, RIO PLUS, DÉCOR & COLUMN).

The TOUCH4 is unique with its precision touch screen interface and easy to use functions.

Product summary

- For use with our electric radiators only
- Up to 4 zones
- Each zone can be set to work in 5/2 or 7-day mode
- 4 switching times per day
- Holiday facility
- Boost facility
- Copy facility
- Mode select (Auto, Constant, Off)

General specification

- GUARANTEE**
2 year guarantee from date of purchase against manufacturing defects.
- IP RATING**
IP20.
- DELIVERY**
2 - 5 working days.

For more general information, please see page 264.

Description	Order Code	Minimum Order Qty
Touch Screen 4 Zone Programmer	TOUCH4	1



NEW!

UNISENZA PLUS SMART CONTROLS

UNISENZA PLUS represents a wireless control solution that allows users to easily connect and control numerous heating and cooling devices at the touch of a button.

If we want to create a better future for ourselves, the next generations and the planet, we have to be smart about it. Smart heating solutions such as the UNISENZA PLUS wireless controls guide us towards an indoor climate that's both comfortable and future-proof.

With only a few components such as the UNISENZA PLUS Gateway, the Electronic Thermostatic Head (ETH), the wireless thermostat and receiver, it's very easy to make different combinations and configure an entire building through the UNISENZA PLUS app. This allows users to monitor and control all the heat transfer systems linked to the app wherever and whenever they want.

Product summary

- Simple, intuitive UNISENZA PLUS app enables centralised comfort control and energy efficiency
- Can add additional gateways, for example holiday homes, and control different systems/properties within the same app
- Connects via Wireless Local Area Network (WLAN) where there is no internet connection (no additional hub required)

General specification

- GUARANTEE**
5 year guarantee from date of purchase against manufacturing defects.
- IP RATING**
IP20.
- DELIVERY**
2 - 5 working days.

For more general information, please see page 264.



UNISENZA PLUS Thermostat RF - 2 Channel

- Wireless Zigbee 3.0 room thermostat that's fast and easy to install
- 2 channels for controlling heating/cooling and domestic hot water time control
- Connect and control up to 6 ETH's with the thermostat, can all be easily controlled via an intuitive app
- Pairing features with UNISENZA PLUS Receiver and Electronic Thermostatic Head
- Optional and flexible temperature management through presence detection

UNISENZA PLUS Gateway

- Central link between devices and to the intuitive UNISENZA PLUS app
- Integration of the latest Zigbee 3.0 wireless technology
- Connects up to 100 end devices with the UNISENZA PLUS app
- Connectivity to smart home systems such as Alexa or Google Home
- Easy to adjust the temperature in individual rooms
- Create and manage one or more comfort zones
- Easy cloud connection – connects multiple devices to the cloud through an Internet router with a WiFi or Ethernet cable connection

UNISENZA PLUS Receiver RF

- Efficient receiver for the wireless control of a boiler, pump or zone valves in a central heating system
- 2 channels for controlling heating/cooling and domestic hot water time control
- Connect and control up to 16 ETH's with the receiver, can all be easily controlled via an intuitive app
- Pairing features with UNISENZA PLUS Thermostat and Electronic Thermostatic Head in the product platform to support multiple applications
- Built-in OpenTherm Controller function with an OT/+ interface auto detection that allows for compatibility with other OpenTherm devices

UNISENZA PLUS Electronic Thermostatic Head (ETH)

- Wireless ETH suitable for easy installation in new build and renovation
- Easy cloud-based control, via an intuitive app, turns it into a smart TRV
- Connectivity to smart home systems such as Alexa or Google Home
- In-app installation and diagnostics
- Standard 2x AA batteries – battery life > 2 years
- Geo location – optional and flexible temperature management through presence detection



Download the **UNISENZA PLUS App** for wireless connection and control



Description	Order Code	Minimum Order Qty
UNISENZA PLUS Programmable Thermostat RF - 2 Channel	UNIPLTHERMRF2	1
UNISENZA PLUS Receiver RF	UNIPLRECRF	1
UNISENZA PLUS Gateway	UNIPLGATEWAY	1
UNISENZA PLUS Electronic Thermostatic Head (ETH)	UNIPLETH	1

NB. a standard single zone heating system will require 1 thermostat, 1 receiver and 1 gateway.

MEP1C, MEP2C, MEP3C & MEPTWOZONE PROGRAMMERS

Our motorised valves are single, dual and triple channel programmers offering energy efficient control of your heating system.



MEP1c is a single channel programmer for use with combi boilers, as a domestic hot water control or with electric radiators when using a programmable thermostat for the central heating circuit.

MEP2c is a dual channel programmer for use with a central heating system and a domestic hot water control.

MEP3c is a three-channel programmer, designed for installations where there is a need for two heating zones and a hot water circuit.

MEPTWOZONE is a dual channel programmer for use within a central heating system to control two heating zones

General specification

- GUARANTEE**
2 year guarantee from date of purchase against manufacturing defects.
- IP RATING**
IP20.
- DELIVERY**
2 - 5 working days.

For more general information, please see page 264.

Product summary

- Easy to use
- Can be set for 24-hour, 5/2 day or 7-day operation
- Easy to read, backlit screen
- Pre-set clock
- Automatic summer/winter time change
- Memory saver - programmer and clock will not require resetting in the event of power loss
- Advanced and extend features for even more control



Description	Order Code	Minimum Order Qty
1 Channel Programmer	MEP1C	1
2 Channel Programmer - 1 x Hot Water & 1 x Central Heating	MEP2C	1
3 Channel Programmer - 1 x Hot Water & 2 x Central Heating	MEP3C	1
2 Channel Programmer - 2 x Central Heating	MEPTWOZONE	1

CONTROL PACKS

MYSON produce a range of control packs, with all the system controls you need in one handy box. They are designed to help installers and specifiers and come with easy-to-follow wiring instructions.

The attractive control packs are designed to give you exactly the right combination of controls to make your central heating system work more efficiently. All the products in each system pack have been developed to be attractive yet unobtrusive and each will complement your home. Correctly installed, the MYSON control system will allow you more effective and economical control of your heating and hot water.

The packs suit all standard types of heating systems and will meet most requirements, from fully pumped flow share and zoned systems to unvented hot water storage systems.

For individual control pack contents, refer to the table below.

General specification

- GUARANTEE**
2 year guarantee from date of purchase against manufacturing defects.
- DELIVERY**
2 - 5 working days.

For more general information, please see page 264.



Please note: Product styles in the Control Packs may change, however, the function will still be the same.

Description	MWB16	MCT1TP	MCT1	UNIDIAL	MPE222	MPE228	MPE322	MEP2C	MEP3C	MEPTWOZONE	Order Code	Minimum Order Qty
MYSON Control pack 1	x1		x1	x1			x1	x1			MCPACK1	1
MYSON Control pack 2	x1		x1	x1	x2			x1			MCPACK2	1
MYSON Control pack 3	x1		x1	x1	x1	x1		x1			MCPACK3	1
MYSON Control pack 4	x1			x1	x1			x1			MCPACK4	1
MYSON Control pack 5	x1			x1		x1		x1			MCPACK5	1
MYSON Control pack 6	x1			x2	x2				x1		MCPACK6	1
MYSON Control pack 9	x1			x2	x2					x1	MCPACK9	1
MYSON Control pack 11	x1		x1	x2	x3				x1		MCPACK11	1
MYSON Control pack 12	x1	x1		x2	x3				x1		MCPACK12	1
MYSON Control pack 14	x1	x1		x1	x2			x1			MCPACK14	1



MOTORIZED VALVES & ACCESSORIES

Motorised valves control the flow of water between heating and hot water zones in domestic fully pumped central heating systems.



The MYSON range of motorised valves has been designed with complete reliability and compatibility in mind. Our motorised valves are compatible as replacements to all leading makes, so you don't need to look anywhere else.

The range has low contact resistance switching for compatibility with the low voltage/low current switching found on many boilers throughout the UK and Europe.

Product summary

- Powerful motor with high grade (Class F) insulation
- Neon valve position indicators
- Gold plated microswitch contacts
- Mica filled PTFE shoes
- Manual override with spring return
- Compatible as replacement to all leading makes
- ISO 9002 Quality Assurance
- Two port valves to control either central heating or hot water circuit
- Three port mid position valves control central heating and hot water circuits simultaneously

2 port valve system diagram

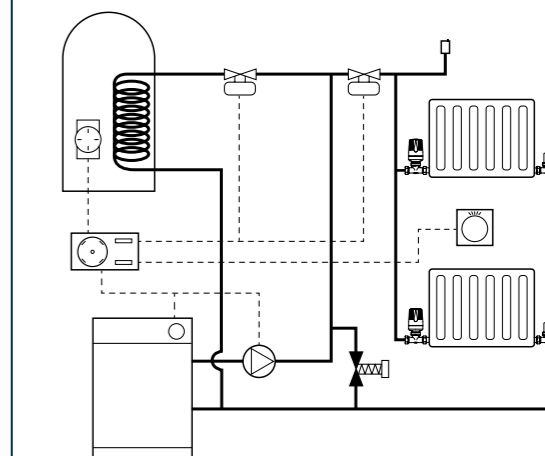

General specification

- GUARANTEE**
2 year guarantee from date of purchase against manufacturing defects.
- DELIVERY**
2 - 5 working days.

For more general information, please see page 264.

3 port valve system diagram

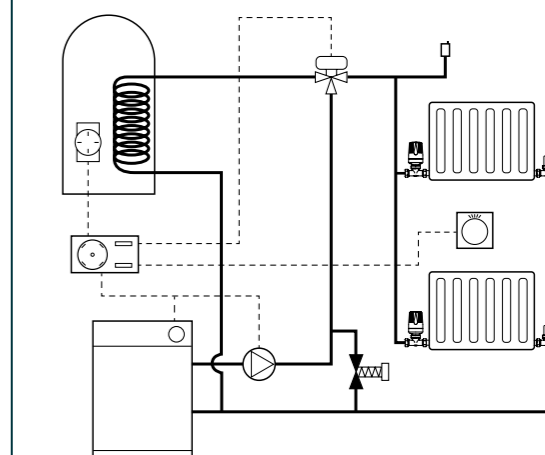

Motorised valves

Description	Order Code	Minimum Order Qty
Two Port Motorised Zone Valve 1" Imperial Olive Compression - Republic of Ireland only	MPE21	1
Two Port Motorised Zone Valve - 22mm	MPE222	1
Two Port Motorised Zone Valve - 28mm	MPE228	1
Two Port Motorised Zone Valve 3/4" Imperial Olive Compression - Republic of Ireland only	MPE23/4	1
Three Port Motorised Divertor Valve - 22mm	MPE322DV	1
Three Port Motorised Zone Valve 3/4" Imperial Olive Compression - Republic of Ireland only	MPE33/4DV	1
Three Port Motorised Zone Mid Position Valve 1" Imperial Olive Compression - Republic of Ireland only	MPE31	1
Three Port Motorised Mid Position Valve - 22mm	MPE322	1
Three Port Motorised Mid Position Valve - 28mm	MPE328	1
Three Port Motorised Zone Mid Position Valve 3/4" Imperial Olive Compression - Republic of Ireland only	MPE33/4	1

Motorised valve accessories

Two Port Actuator Head Only (For MPE222, MPE23/4)	ACT222	1
Two Port Actuator Head Only (For MPE228, MPE21)	ACT228	1
Three Port Actuator Head (For MPE322, MPE328, MPE33/4, MPE31)	ACT322	1



GENERAL INFORMATION

UKCA & CE MARKING

All MYSON products have been assessed against UK and EU Directives, Regulations and standards and carry the CE mark and the UKCA mark where applicable.

PACKAGING

All MYSON products are packed in robust packaging specially designed to ensure that the product reaches you in perfect condition.

INHIBITORS

All products installed onto indirect hydronic systems must be cleaned and protected (includes the use of an inhibitor) in accordance with the Domestic Building Services Compliance Guide and to the British Standard Code of Practice for Water Treatment. Failure to meet the regulations under BS7593 compliance will invalidate the product warranty.

SAFETY PRECAUTIONS

Radiators are hot when in use, and as such, present a risk of burns to users on prolonged contact. The temperature of a radiator is dependent on the temperature of the system water, as set by the system installer or user. Installers and users should ensure that those who may come into close proximity to hot radiators are aware of the risk of burns. Installers and users should take all necessary steps to minimise the risks of burns.

If the risk is significant, consideration should be given to installing low surface temperature radiators, or to placing guards in front of the radiators.

FIXINGS

For the correct installation of radiators it is essential that the fixing of the radiator is carried out in such a way that it is suitable for intended use AND predictable misuse. A number of elements need to be taken into consideration including the fixing method used to secure the radiator to the wall, the type and condition of the wall itself, and any

additional potential forces or weights that may happen to be applied to the radiator, prior to finalising installation. IN ALL CASES IT IS STRONGLY RECOMMENDED THAT A SUITABLY QUALIFIED PROFESSIONAL INSTALLER OR SIMILAR TRADESPERSON CARRIES OUT THE INSTALLATION.

PLEASE NOTE: The fixing materials provided are only intended for installation on walls made of solid wood, bricks, concrete or on timber-frame stud walls where the fixing is into the timber. All walls being considered should have no more than a maximum of 3mm wall finishing. For walls made of other materials, for example hollow bricks, please consult your installer and/or specialist supplier. ONCE AGAIN, IF YOU ARE UNSURE, IT IS STRONGLY RECOMMENDED THAT A SUITABLY QUALIFIED PROFESSIONAL INSTALLER OR SIMILAR TRADESPERSON CARRIES OUT THE INSTALLATION.

APPLICATION

Most MYSON products are for use on 2 pipe pumped indirect domestic and commercial central heating installations, with a maximum working temperature of 100°C. The system should be designed in accordance with BS EN 12828:2003 or BS EN 12831:2003 as appropriate, with particular care taken to avoid air entry or water discharge.

We do not recommend the use of single feed indirect cylinders, as the possibility of aeration due to water interchange may lead to corrosion. The installation work must be carried out in accordance with recognised good practice, and precautions taken to avoid contamination which could lead to corrosion. If a corrosion inhibitor or other water treatment is to be used, the Manufacturer's Instructions must be strictly followed.

The recommendations of BS 7593, Code of Practice for treatment of water in domestic hot water central heating systems, should be followed where appropriate.

When fitting any heat emitter in an extremely high humidity environment (for example a swimming pool area or sports changing facility) products manufactured from steel should be avoided.

CERTIFICATION FOR NPD PRODUCTS

Products highlighted 'No Performance Declared' (NPD) have heat outputs below the measurable limits of EN 442 test methods and calculated outputs are therefore shown.

DEZINCIFICATION

In certain areas, the local water can gradually remove zinc from brass alloys. This process is called dezincification and, on rare occasions and over time, can affect the integrity of a brass product.

All MYSON brass products are manufactured using dezincification resistant brass. This, however, does not entirely eliminate the possibility of dezincification occurring. These products can be used on any hot water central heating system and are identified within the brochure using the  symbol. MYSON insist that you ask your heating engineer/installer if this problem applies to your area, as MYSON can not be held responsible for any resulting damage.

ELECTRICAL INSTALLATION

All electrical models must be hard wired and installed in the correct orientation by a qualified electrician, in accordance with the IEE wiring regulations BS 7671.

IP RATINGS

IP ratings are shown for all electrical products. This must be considered when installing in a location containing a bath or shower, as defined by BS 7671.

By returning the product, you will help to prevent possible negative effects on the environment and health to which the product can contribute if it is disposed of as ordinary domestic waste. For information about recycling and collection facilities, you should contact your local authority/municipality or refuse collection service or the business from which you purchased the product. Applicable to countries where this Directive has been adopted.

DUAL FUEL

This allows a hydronic product to be used if the central heating system is not active. The pipe centres featured in this brochure are based on hydronic products. When adding heater kits to multi-rails, a T-piece and element will be required that alters the pipe centre dimensions (see diagram). The difference in pipe centres featured are based on using MYSON valves. These differences may vary on other manufacturers' valves. For the most efficient operation, one valve should be open and one valve should be closed. Avoid closing both valves.

AUTO POWER MANAGEMENT SYSTEM (APM®)

APM® represents the most advanced element technology available. It is an economical, self-regulating element. When it reaches the required temperature, it reduces power consumption accordingly. There is no need for a thermostat. The required temperature is achieved smoothly and stays constant. APM® is now fitted to all PTC and MHK heating elements and most MYSON electric units where stated.

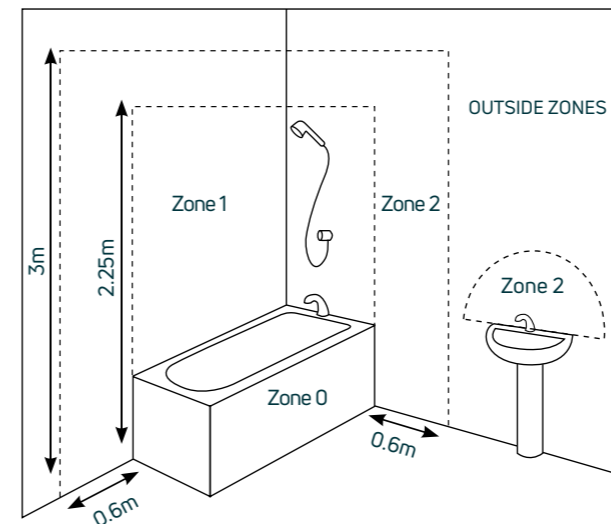

Suitable Zones.



Dual fuel heater kits pipe centre adjustment.

WASTE DISPOSAL ACCORDING TO THE WEEE DIRECTIVE (2012/19/EU)

Waste disposal according to the WEEE Directive (2012/19/EU). The symbol on the product label indicates that the product may not be handled as domestic waste, but must be sorted separately. When it reaches the end of its useful life, it shall be returned to a collection facility for electrical and electronic products.

Certificates & accreditations

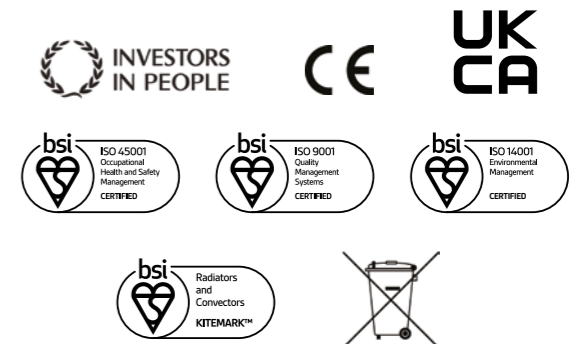

Colour options

The majority of products featured in this brochure are stocked in white (RAL 9016). Other colours are available on request (see below and right). Please refer to individual product pages as not all products can be ordered in other RAL, sanitary or special colours.





STANDARD RAL COLOURS

MYSON offers the following RAL colours. If the colour you require is not included in this colour chart, please contact our customer services for availability. Standard RAL colours are 70% gloss.

 Traffic White RAL 9016	 Traffic Blue RAL 5017	 Red Violet RAL 4002	 Light Grey RAL 7035
 Pure White RAL 9010	 Night Blue RAL 5022	 Purple Violet RAL 4007	 Window Grey RAL 7040
 Cream RAL 9001	 Ultramarine Blue RAL 5002	 Signal Violet RAL 4008	 Silver Grey RAL 7001
 Traffic Yellow RAL 1023	 Green Blue RAL 5001	 Pastel Violet RAL 4009	 Dusty Grey RAL 7037
 Lemon Yellow RAL 1012	 Jet Black RAL 9005	 Light Pink RAL 3015	 Stone Grey RAL 7030
 Golden Yellow RAL 1004	 Black Grey RAL 7021	 Antique Pink RAL 3014	 Brown Grey RAL 7013
 Curry Yellow RAL 1027	 Dahlia Yellow RAL 1033	 Pastel Green RAL 6019	 Slate Grey RAL 7015
 Pastel Turquoise RAL 6034	 Pastel Orange RAL 2003	 Mint Turquoise RAL 6033	 Anthracite Grey RAL 7016
 Pigeon Blue RAL 5014	 Pure Orange RAL 2004	 Blue Green RAL 6004	 Graphite Grey RAL 7024
 Azure Blue RAL 5009	 Flame Red RAL 3000	 Chocolate Brown RAL 8017	 White Aluminium RAL 9006
 Sky Blue RAL 5015	 Wine Red RAL 3005	 Grey Brown RAL 8019	 Grey Aluminium RAL 9007

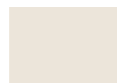
SANITARY COLOURS

MYSON offers the following sanitary colours. If the colour you require is not included in this colour chart, please contact our customer services for availability. Sanitary colours are 50% gloss.



 Jasmine S0075	 Pergamon S0091	 Natural S0094	 Bahama Beige S0087
 Manhattan S0088			



SPECIAL COLOURS

MYSON also offers the following textured, metallic and shimmer metallic colours.



TEXTURED

 Black Textured S0141	 White Textured S0142
---	---

METALLIC

 Cream White S0145	 Light Grey S0143	 Brown Grey S0144	 Anodic Natural S0149
 Anodic Bronze S0146	 Anodic Brown S0147	 Anodic Black S0148	

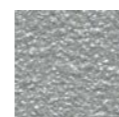
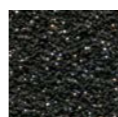
SHIMMER METALLIC

 Metal Alu S0201	 Metal Black S0104	 Metal Grey S0102
--	--	---

All our non-stocked and special colour items are made to order, refer to individual product pages for lead times. Should an order be cancelled after it has been placed with the factory an administration fee of 30% of the product value may be applied.

Please note: due to print restrictions exact colour match is not always possible, however every effort has been made to ensure as much accuracy as possible.

Heat output calculation

All heat outputs listed in this brochure are quoted at ΔT_{30} , for low temperature systems, and ΔT_{50} . To calculate outputs at alternative ΔT , please use the following steps:

Symbols used:

t_1 = Flow temperature
 t_2 = Return temperature
 t_r = Ambient air temperature
 ΔT = Delta T
 Φ = Heat output

ΔT_{50} = Temperature difference between water and air

EG:

$$\Delta T = \left(\frac{t_1 + t_2}{2} \right) - t_r$$

$t_1 = 75^\circ\text{C}$, $t_2 = 65^\circ\text{C}$, $t_r = 20^\circ\text{C}$

Therefore:

$$\Delta T = \left(\frac{75 + 65}{2} \right) - 20$$

$\Delta T = 50$ (shown as ΔT_{50})

ΔT_x = If other conditions are used then a new ΔT needs to be determined:

EG:

For the condition 80/70/18

$$\Delta T_x = \left(\frac{t_1 + t_2}{2} \right) - t_r$$

$t_1 = 80^\circ\text{C}$, $t_2 = 70^\circ\text{C}$, $t_r = 18^\circ\text{C}$

Therefore:

$$\Delta T_x = \left(\frac{80 + 70}{2} \right) - 18$$

$\Delta T_x = 57$ (shown as ΔT_{57})

$\Phi_{\Delta T_{50}}$ = Heat output at ΔT_{50} or the condition 75/65/20

EG:

A MYSON PLAN COMPACT 60 PD 100G
 (600x1000 T22) gives 1676W @ ΔT_{50}

$\Phi_{\Delta T_x}$ = Heat output at an alternative ΔT or condition to ΔT_{50} or 75/65/18

EG:

For ΔT_{57} or the condition 80/70/18
 (see example above)

$$\Phi_{\Delta T_x} = \Phi_{\Delta T_{50}} \times \left(\frac{\Delta T_x}{\Delta T_{50}} \right)^n$$

$\Phi_{\Delta T_x} = \Phi_{\Delta T_{57}}$, $\Phi_{\Delta T_{50}} = 1676\text{W}$, $\Delta T_x = \Delta T_{57} = 57$,
 $\Delta T_{50} = 50$, $n = 1.3295$ (see individual product pages for n-coefficients)

Therefore:

$$\Phi_{\Delta T_x} = 1676 \times \left(\frac{57}{50} \right)^{1.3295}$$

$\Phi_{\Delta T_{57}} = 1994\text{W}$

Product warranty

Thank you for purchasing a Purmo Group (UK) Ltd (Purmo Group) product. Your Purmo Group product has been designed and tested to give you many years of trouble-free service. For your additional peace of mind, Purmo Group gives the following Warranty against manufacturing defect. Your statutory rights are not affected by this Warranty.

Subject as provided below, Purmo Group warrants to the original purchaser at the original installation site that its products will be free from defects in materials and workmanship for the following periods:

- **Hydronic Radiators:** 10 years from date of purchase.*
- **Fan Assisted Radiators (ULOW-E2):** 2 years from date of purchase.*
- **Fan Convectors:** 2 years from date of purchase.
- **Hydronic Underfloor Heating:** 10 years for the pipe from date of purchase.
- **Hydronic Underfloor Heating:** 2 years on accessories, actuators, ball valves, controls, expansion vessels, fittings, low loss headers, manifolds, mixer control groups & tooling from date of purchase.
- **Hydronic Underfloor Heating:** 12 months on all pumps from date of purchase.
- **Electric Underfloor Heating:** 10 years from date of purchase (except programmer & sensor).
- **Electric Radiators and Towel Warmers:** 2 years from date of purchase.*
- **Hydronic Towel Warmers:** 5 to 10 years from date of purchase depending on product type.*
- **MYSON Radiator Valves and Controls:** 2 to 5 years from date of purchase, depending on product range.

*Products which are exposed to prolonged extreme conditions, such as high humidity or severe cold/condensation, may be subject to deterioration. This is not a result of any manufacturing defect. Products installed in these circumstances will be subject to a warranty period of twelve months only.

The original purchaser's remedy for breach of this Warranty is expressly limited to repair or replacement of any part or parts found to be defective under conditions of normal service and use during the above Warranty period and does not extend to Purmo Group being liable for any incidental, special or consequential damages or losses whatsoever, such as loss of use of the product, inconvenience or lost profits.

This Warranty does not cover any defect, damage or malfunction in the product which is due to: failure to comply in any respect with Purmo Group's installation, maintenance or operating instructions; faulty storage, handling, installation or repair; mis-use; neglect; accident; abuse; or general wear and tear.

Before this warranty can be activated, the original purchaser will be required to prove, with supporting documentation, the date and place of purchase, as Purmo Group may need to conduct its investigation into the alleged defect. This should be within 28 days of the date when the defect was discovered or ought to have reasonably discovered the defect.

Purmo Group reserves the right to make a reasonable charge for inspecting and testing any product which is subject to a Warranty claim and the rights conferred by the Warranty are conditional upon the payment of such charge. The charge may be made, at Purmo Group's discretion, either before or after the inspection and testing of the product. In the event that it is established to Purmo Group's reasonable satisfaction that a valid Warranty claim has been made in respect of the product, then any inspection charge which has been paid will be refunded in full by Purmo Group.

2024

Index

PRODUCT	PAGE
ANGARA	132
AUTOMATIC BYPASS VALVES	246
AVONMORE	130
AVONMORE ELECTRIC	216
AWE	120
BUTTERMERE	121
CLIPRAIL	179
COLUMN	82
COLUMN ELECTRIC	214
CONTROL PACKS	261
DÉCOR	88
DÉCOR ELECTRIC	212
DECORATIVE MANUAL VALVES	234
DECORATIVE (TRV)	232
DEE	122
ELECTRIC UNDERFLOOR HEATING	222
ELECTRONIC THERMOSTATIC HEAD (ETH)	247
FARO V	70
FATALA	108
FERLO	134
FINESSE	206
FLOATING FLOOR	186
FULLFLOW	230
HI-LINE LV	150
HI-LINE RC	150
INN	124
INNOKO	220
INTERLUDE	109
IVECTOR S2	156
KASAI	110
KICKSPACE®	144
KICKSPACE® CONTROLS, ACCESSORIES & GRILLES	146
KICKSPACE® ELECTRIC	144
KOS V	70
LINDI	136
LO-LINE RC	150
LST (LOW SURFACE TEMPERATURE)	38
LST (LOW SURFACE TEMPERATURE) VERTICAL	38
LST TRV KITS & ACCESSORIES	242
MANIFOLDS (PREMIUM)	194
MARANOVA	112
MATCHMASTER	228
MATCHMATE	226
MCT1	253
MEPIC	260
MEP2C	260
MEP3C	260
MEPTWOZONE	260
MERSEY	114
MICROBOARD	187
MICROPLATE	182
MOTORISED VALVES & ACCESSORIES	262
MPRT	254
MULTI-LAYER PIPE	191
MYSON PLUS	240
NAKED PREFORMED PLATE	181
OPUS	98
OUSE	115

PRODUCT	PAGE
PAROS V	70
PETITE (TRV)	238
PEXCELLENT5 PIPE	190
PLAN	48
PLAN PLUS	48
PLATED	184
PREFORMED PLATE	180
PREMIER HE	16
PREMIER METRIC	16
PUMP PACK (PREMIUM)	196
REMOTE THERMOSTATS	244
RIO COMPACT PLUS	208
RIO LINEA PLUS	208
RIO PLAN PLUS	208
SAXBY	125
SELECT COMPACT	26
SOKOTO	116
STOUR	117
SUBPLATE	185
T6 COMPACT	54
T6 PLAN	54
TACKER	183
TACKERNAIL	178
TAMAR	218
THIRLMERE	126
TINOS V	70
TOPAZ	106
TOUCH	255
TOUCH2 WIFI	256
TOUCH4	257
TOWEL WARMERS ACCESSORIES	140
TRV2	236
TYNE	138
ULLSWATER	127
ULOW-E2	64
UNDERFLOOR HEATING	171
ADAPTORS	195
CONTROLS	192
ELECTRIC UNDERFLOOR	222
FIXING SYSTEMS	176
MANIFOLDS (PREMIUM)	194
PIPE	188
PUMP PACK (PREMIUM)	196
SINGLE ROOM PACKS	200
WIRING CENTRES & THERMOSTATS	198
UNISENZA DIAL	250
UNISENZA DIGITAL	251
UNISENZA PLUS	258
UNISENZA WIFI	252
VALVES & ACCESSORIES	225
VERTICAL	32 / 70
VERTICAL ACCESSORIES	37

DISCLAIMER

The information contained in this brochure is correct at the time of publication. In accordance with our policy of continual product improvement we reserve the right to amend the specification of these products or discontinue products without prior notification. We have compiled the content of this literature to the best of our knowledge. Any typographical, clerical or other error or omission in any literature issued by us will be subject to correction without liability being incurred by us. All rights reserved. No part of this document may be reproduced by any means without prior written consent.

Please note: due to print restrictions exact colour match is not always possible, however every effort has been made to ensure as much accuracy as possible.



August 2024, Issue 11

MYSON

Purmo Group (UK) Ltd.
Eastern Avenue
Team Valley
Gateshead
Tyne & Wear
NE11 0PG, UK
T: +44 (0) 330 041 5474
F: +44 (0) 191 491 7568
E: generalenquiries.uk@purmogroup.com
www.myson.co.uk

